



**NATIONAL HOCKEY LEAGUE**

**Official Rules  
2009-2010**

© Copyright 2009 National Hockey League

All rights reserved. This book may not be reproduced in whole or in part in any form or by any means, electronic or mechanical, including photocopying, recording or by any information storage and retrieval system now known or hereafter invented, without written permission from the National Hockey League.

## **National Hockey League Official Rules 2009-2010**

NHL and the NHL Shield are registered trademarks of the National Hockey League. All NHL logos and marks and team logos and marks depicted herein are the property of the NHL and the respective teams and may not be reproduced without the prior written consent of NHL Enterprises L.P. © NHL 2009. All rights reserved.

Diagrams of equipment and officials' signals reproduced courtesy of USA Hockey, Inc.

Printed in Canada.

Design, production by:  
Dan Diamond and Associates, Inc.  
194 Dovercourt Road  
Toronto, Ontario M6J 3C8 416-531-6535 Fax 416-531-3939

Distributed in Canada by:  
North 49 Books  
35 Prince Andrew Drive  
Toronto, Ontario M3C 2H2 416-449-4000 Fax 416-449-9924

Published in the United States of America by:  
Triumph Books  
542 South Dearborn Street, Suite 750  
Chicago, Illinois 60605 312-939-3330 Fax 312-663-3557

ISBN: 978-1-894801-18-8

### **The National Hockey League**

1185 Avenue of the Americas, New York, New York 10036  
1800 McGill College Avenue, Suite 2600, Montreal, Quebec H3A 3J6  
50 Bay Street, 11<sup>th</sup> Floor, Toronto, Ontario M5J 2X8

**[www.NHL.com](http://www.NHL.com)**



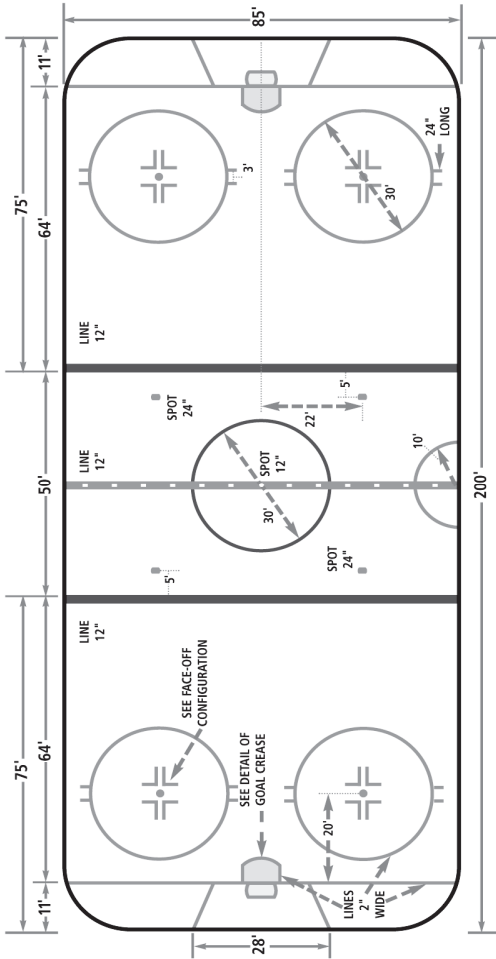

OFFICIAL DIMENSIONS OF RINK SURFACE

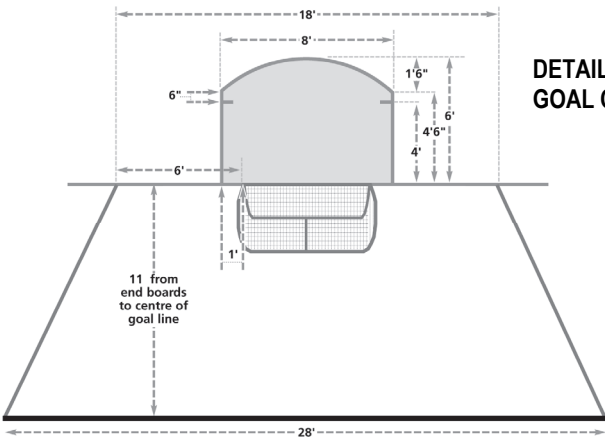

DETAIL OF GOAL CREASE

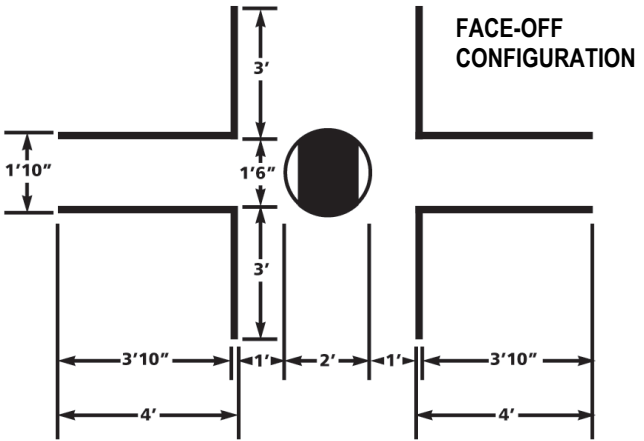

ALL LINES ARE 2" IN WIDTH

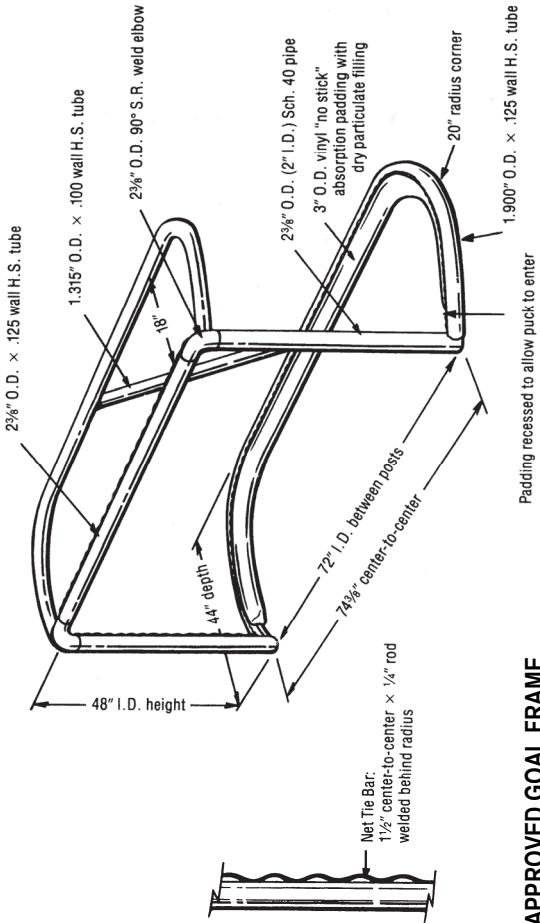

<b>Table of Contents</b> .....	vii
<b>Section 1 – Playing Area</b> .....	1
<b>Section 2 – Teams</b> .....	6
<b>Section 3 – Equipment</b> .....	11
<b>Section 4 – Types of Penalties</b> .....	25
<b>Section 5 – Officials</b> .....	48
<b>Section 6 – Physical Fouls</b> .....	66
<b>Section 7 – Restraining Fouls</b> .....	79
<b>Section 8 – Stick Fouls</b> .....	84
<b>Section 9 – Other Fouls</b> .....	87
<b>Section 10 – Game Flow</b> .....	107
<b>Reference Tables</b> .....	132
<b>Index</b> .....	160
<b>2008-2009 NHL Schedule</b> .....	209

**Section 1 – Playing Area**

Rule 1 – Rink .....	1
Rule 2 – Goal Posts and Nets .....	3
Rule 3 – Benches .....	4
Rule 4 – Signal and Timing Devices .....	5

**Section 2 – Teams**

Rule 5 – Team .....	6
Rule 6 – Captain and Alternate Captains .....	7
Rule 7 – Starting Line-up .....	8
Rule 8 – Injured Players .....	9

**Section 3 – Equipment**

Rule 9 – Uniforms .....	11
Rule 10 – Sticks .....	14
Rule 11 – Goalkeeper’s Equipment .....	19
Rule 12 – Illegal Equipment .....	23
Rule 13 – Puck .....	23
Rule 14 – Adjustment to Clothing or Equipment .....	24

**Section 4 – Types of Penalties**

Rule 15 – Calling of Penalties .....	25
Rule 16 – Minor Penalties .....	26
Rule 17 – Bench Minor Penalties .....	27
Rule 18 – Double-minor Penalties .....	27
Rule 19 – Coincidental Penalties .....	28
Rule 20 – Major Penalties .....	30
Rule 21 – Match Penalties .....	31
Rule 22 – Misconduct Penalties .....	32
Rule 23 – Game Misconduct Penalties .....	33
Rule 24 – (Not in use) .....	35
Rule 25 – Penalty Shot .....	35
Rule 26 – Awarded Goals .....	39
Rule 27 – Delayed Penalties .....	39
Rule 28 – Goalkeeper’s Penalties .....	40
Rule 29 – Supplementary Discipline .....	42
Rule 30 – Signals .....	42

**Section 5 – Officials**

Rule 31 – Appointment of Officials .....	48
Rule 32 – Referees .....	48
Rule 33 – Linesmen .....	50
Rule 34 – Official Scorer .....	52
Rule 35 – Game Timekeeper .....	54
Rule 36 – Penalty Timekeeper .....	55



**Section 5 – Officials (continued)**

Rule 37 – Goal Judge .....	57
Rule 38 – Real Time Scorers.....	58
Rule 39 – Video Goal Judge .....	58
Rule 40 – Abuse of Officials.....	61
Rule 41 – Physical Abuse of Officials .....	63

**Section 6 – Physical Fouls**

Rule 42 – Boarding .....	66
Rule 43 – Charging .....	67
Rule 44 - Checking from Behind.....	67
Rule 45 – Clipping.....	68
Rule 46 – Elbowing .....	69
Rule 47 – Fighting.....	69
Rule 48 - Head-butting .....	75
Rule 49 – Kicking .....	75
Rule 50 – Kneeing.....	76
Rule 51 – Roughing .....	76
Rule 52 - Slew-footing.....	77
Rule 53 - Throwing Equipment .....	77

**Section 7 – Restraining Fouls**

Rule 54 – Holding.....	79
Rule 55 – Hooking.....	79
Rule 56 – Interference .....	80
Rule 57 – Tripping.....	82

**Section 8 – Stick Fouls**

Rule 58 – Butt-ending .....	84
Rule 59 – Cross-checking.....	84
Rule 60 – High-sticking .....	84
Rule 55 – Hooking.....	(79) 85
Rule 61 – Slashing .....	85
Rule 62 – Spearing .....	86

**Section 9 – Other Fouls**

Rule 63 – Delaying the Game .....	87
Rule 64 – Diving / Embellishment.....	90
Rule 65 – Equipment .....	91
Rule 66 - Forfeit of Game .....	91
Rule 67 – Handling Puck .....	91
Rule 68 – Illegal Substitution .....	93
Rule 69 – Interference on the Goalkeeper.....	94
Rule 70 – Leaving the Bench.....	96
Rule 71 – Premature Substitution .....	100





**Section 9 – Other Fouls (continued)**

Rule 72 – Refusing to Play the Puck.....	101
Rule 73 – Refusing to Start Play .....	102
Rule 74 – Too Many Men on the Ice .....	103
Rule 75 - Unsportsmanlike Conduct .....	104

**Section 10 – Game Flow**

Rule 76 – Face-offs .....	107
Rule 77 – Game and Intermission Timing.....	112
Rule 78 – Goals.....	112
Rule 79 – Hand Pass .....	115
Rule 80 – High-sticking the Puck .....	116
Rule 81 – Icing.....	117
Rule 82 – Line Changes.....	119
Rule 83 – Off-side .....	121
Rule 84 – Overtime .....	124
Rule 85 – Puck Out of Bounds.....	127
Rule 86 – Start of Game and Periods .....	129
Rule 87 – Time-outs.....	130

**Reference Tables**

<b>Table 1</b>	Summary of Penalties to Coaches and Non-playing Club Personnel .....	132
<b>Table 2</b>	Summary of Minor Penalties .....	132
<b>Table 3</b>	Summary of Bench Minor Penalties.....	133
<b>Table 4</b>	Summary of Double-minor Penalties .....	134
<b>Table 5</b>	Summary of Major Penalties .....	134
<b>Table 6</b>	Summary of Major Penalties That Result in an Automatic Game Misconduct .....	134
<b>Table 7</b>	Summary of Major Penalties That Result in an Automatic Game Misconduct When There is Injury to the Face or Head.....	135
<b>Table 8</b>	Summary of Match Penalties .....	135
<b>Table 9</b>	Summary of Misconduct Penalties.....	136
<b>Table 10</b>	Summary of Game Misconduct Fouls Included in the “General Category” .....	137



**Reference Tables (continued)**

**Table 11**  
 Summary of Game Misconduct Fouls  
 Included in the “Stick-Related Category” ..... 137

**Table 12**  
 Summary of Game Misconduct Penalties..... 138

**Table 13**  
 Summary of Penalty Shots ..... 138

**Table 14**  
 Summary of Awarded Goals (When  
 Goalkeeper Has Been Removed  
 for an Extra Attacker)..... 139

**Table 15**  
 Summary of Goalkeeper Penalties ..... 139

**Table 16**  
 Goals Scored Against a Short-handed Team..... 140

**Table 17**  
 Coincidental Penalties ..... 149

**Table 18**  
 Interference on the Goalkeeper Situations ..... 152

**Table 19**  
 Penalties in Effect Prior to the Start of  
 Overtime – Regular Season ..... 158

**Table 20**  
 Penalties Assessed in Overtime – Regular  
 Season..... 159

**Index**..... 160

**2009-10 NHL Schedule**..... 209



## SECTION 1 – PLAYING AREA

### Rule 1 – Rink

- 1.1 **Rink** - National Hockey League games shall be played on an ice surface known as the “Rink” and must adhere to the dimensions and specifications prescribed by the League and these rules. No ice markings shall be permitted except those provided for under these rules unless express written permission has been obtained from the League. On-ice logos must not interfere with any official ice markings provided for the proper playing of the game.

In the interval between periods, the ice surface shall be flooded unless mutually agreed to the contrary.

- 1.2 **Dimensions** - The official size of the rink shall be two hundred feet (200') long and eighty-five feet (85') wide. The corners shall be rounded in the arc of a circle with a radius of twenty-eight feet (28'). See diagram on page iv preceding the table of contents.
- 1.3 **Boards and Glass** - The rink shall be surrounded by a wall known as the “boards” which shall extend not less than forty inches (40”) and not more than forty-eight inches (48”) above the level of the ice surface. The ideal height of the boards above the ice surface shall be forty-two inches (42”). Except for the official markings provided for in these rules, the entire playing surface and the boards shall be white in color except the kick plate at the bottom of the boards, which shall be light yellow in color.

Any variations from any of the foregoing dimensions shall require official authorization by the League.

The boards shall be constructed in such a manner that the surface facing the ice shall be smooth and free of any obstruction or any object that could cause injury to players.

Affixed to the boards and extending vertically shall be approved safety glass extending eight feet (8') above the boards at each end of the rink and not less than five feet (5') along both sides of the rink.

The glass and gear to hold them in position shall be properly padded or protected. Protective glass shall be required in front of the penalty benches to provide for the safety of the players on and off the ice. All equipment used to hold the glass or screens in position shall be mounted on the boards on the side away from the playing surface.

- 1.4 **Spectator Netting** – Spectator netting shall be hung in the ends of the arena, of a height, type, and in a manner approved by the League.
- 1.5 **Lines** - Eleven feet (11') from each end of the rink and in the center of a red line two inches (2”) wide drawn completely across the width of the ice and continued vertically up the side of the boards, regulation goal posts and nets shall be set in such a manner as to remain stationary during the progress of a game.

The red line, two inches (2”) wide, between the goal posts on the ice and extended completely across the rink, shall be known as the “GOAL LINE.”

In front of each goal, a “GOAL CREASE” area shall be marked by



a red line two inches (2") in width.

The ice area between the two goals shall be divided into three parts by lines, twelve inches (12") in width, and blue in color, drawn sixty-four feet (64') out from the goal lines, and extended completely across the rink, parallel with the goal lines, and continued vertically up the side of the boards. (Paint code PMS 286.)

There shall also be a line, twelve inches (12") in width and red in color, drawn completely across the rink in center ice, parallel with the goal lines and continued vertically up the side of the boards, known as the "CENTER LINE." This line shall contain regular interval markings of a uniform distinctive design, which will readily distinguish it from the two blue lines, the outer edges of which must be continuous. (Paint code PMS 186.)

- 1.6 **Division of Ice Surface** - That portion of the ice surface in which the goal is situated shall be called the "DEFENDING ZONE" of the Team defending that goal; the central portion shall be known as the "NEUTRAL ZONE," and the portion farthest from the defended goal as the "ATTACKING ZONE."
- 1.7 **Goal Crease / Referee Crease** - The goal crease shall be laid out as follows: One foot (1') outside of each goal post a two-inch (2") line shall be painted extending four feet, six inches (4'6") in length. These lines shall be at right angles to the goal line. A semi-circle line six feet (6') in radius and two inches (2") in width shall be drawn using the center of the goal line as the center point and connecting both ends of the side of the crease. On the side of the crease lines, four feet (4') from the goal line, extend a five-inch (5") line into the crease. (see diagram on page iv preceding the table of contents)
- The goal crease area shall include all the space outlined by the crease lines and extending vertically four feet (4') to the level of the top of the goal frame. The area outlined by the crease line and the goal line shall be painted a light blue color. (Paint code PMS 298.)
- The area inside the goal frame to the goal line shall be painted a gloss white color.
- On the ice immediately in front of the Penalty Timekeeper's seat there shall be marked in red on the ice a semi-circle of ten foot (10') radius and two inches (2") in width which shall be known as the "REFEREE'S CREASE."
- 1.8 **Goalkeeper's Restricted Area** - A restricted trapezoid-shaped area behind the goal will be laid out as follows: Five feet (5') outside of each goal crease (six feet (6') from each goal post), a two-inch (2") red line shall be painted extending from the goal line to a point on the end of the rink ten feet (10') from the goal crease (eleven feet (11') from the goal post) and continuing vertically up the kick plate (see diagram on the page iv preceding the table of contents). (Paint code PMS 186).
- 1.9 **Face-off Spots and Circles** - A circular blue spot, twelve inches (12") in diameter, shall be marked exactly in the center of the rink; and with this spot as a center, a circle of fifteen feet (15') radius shall be marked with a blue line two inches (2") in width.

Two red spots two feet (2') in diameter shall be marked on the ice



in the neutral zone five feet (5') from each blue line. Within the face-off spot, draw two parallel lines three inches (3") from the top and bottom of the spot. The area within the two lines shall be painted red, the remainder shall be painted white. The spots shall be forty-four feet (44') apart and each shall be a uniform distance from the adjacent boards.

In both end zones and on both sides of each goal, red face-off spots and circles shall be marked on the ice. The face-off spots shall be two feet (2') in diameter. Within the face-off spot, draw two parallel lines three inches (3") from the top and bottom of the spot. The area within the two lines shall be painted red, the remainder shall be painted white.

The circles shall be two inches (2") wide with a radius of fifteen feet (15') from the center of the face-off spots. At the outer edge of both sides of each face-off circle and parallel to the goal line shall be marked two red lines, two inches (2") wide and two feet (2') in length and three feet (3') apart.

One foot away from the outer edge of the face-off spot, two lines shall be drawn parallel with the side boards that shall be four feet (4') in length and eighteen inches (18") apart. Parallel to the end boards, commencing at the end of the line nearest to the face-off spot, a line shall extend two feet ten inches (2'10") in length. All lines shall be two inches (2") in width. See diagram on page v preceding the table of contents.

The location of the face-off spots shall be fixed in the following manner:

Along a line twenty feet (20') from each goal line and parallel to it, mark two points twenty-two feet (22') on both sides of the straight line joining the center of the two goals. Each such point shall be the center of a face-off spot and circle.

## **Rule 2 – Goal Posts and Nets**

- 2.1 **Goal Posts** - The goal posts shall be kept in position by means of flexible pegs affixed in the ice or floor. The flexible pegs shall be ten inches (10") in length and bright lime green in color.

The goal posts shall be of approved design and material, extending vertically four feet (4') above the surface of the ice and set six feet (6') apart measured from the inside of the posts. A crossbar of the same material as the goal posts shall extend from the top of one post to the top of the other. See diagram on page v preceding table of contents.

The goal posts and crossbar shall be painted in red and all other exterior surfaces shall be painted in white.

- 2.2 **Nets** - There shall be attached to each goal frame a net of approved design made of white nylon cord which shall be draped in such a manner as to prevent the puck coming to rest on the outside of it, yet strung in a manner that will keep the puck in the net.

A skirt of heavy white nylon fabric or heavyweight white canvas shall be laced around the base plate of the goal frame in such a way



as to protect the net from being cut or broken. This protective padding must be attached in a manner that will not restrict the puck from completely crossing the goal line. This padding must be set back six inches (6") from the inside of the goal post. This skirt shall not project more than one inch (1") above the base plate.

The frame of the goal shall be draped with a nylon mesh net so as to completely enclose the back of the frame. The net shall be made of three-ply twisted twine (0.197 inch (5 mm) diameter) or equivalent braided twine of multifilament white nylon with an appropriate tensile strength of 700 pounds. The size of the mesh shall be two and one-half inches (2½") (inside measurement) from each knot to each diagonal knot when fully stretched. Knotting shall be made as to ensure no sliding of the twine. The net shall be laced to the frame with medium white nylon cord no smaller in size than No. 21.

### **Rule 3 – Benches**

- 3.1 **Players' Benches** - Each rink shall be provided with seats or benches for the use of players of both teams. The accommodations provided, including benches and doors, **MUST** be uniform for both teams. Such seats or benches shall have accommodation for at least fourteen (14) persons of each team. The benches shall be placed immediately alongside the ice as near to the center of the rink as possible. Two doors for each bench must be uniform in location and size and as convenient to the dressing rooms as possible.

Each players' bench should be twenty-four feet (24') in length and when situated in the spectator area, shall be separated from the spectators by a protective glass of sufficient height so as to afford the necessary protection for the players. The players' benches shall be on the same side of the playing surface opposite the penalty bench and should be separated by a substantial distance, if possible.

Each players' bench shall have two doors which must be uniform in location and size. ("Mirrored image benches") All doors opening to the playing surface shall be constructed so that they swing inward.

- 3.2 **Penalty Bench** - Each rink must be provided with benches or seats to be known as the "PENALTY BENCH." These benches or seats must be capable of accommodating a total of ten persons including the Penalty Timekeepers. Separate penalty benches shall be provided for each Team and they shall be situated on opposite sides of the Timekeeper's area, directly across the ice from the players' benches. The penalty bench(es) must be situated in the neutral zone.

Each Penalty Bench shall be protected from the spectator area by means of a glass partition which shall not be less than five feet (5') above the height of the boards.



## **Rule 4 – Signal and Timing Devices**

- 4.1 **Signal Devices** - Each rink must be provided with a siren, or other suitable sound device that will sound automatically at the conclusion of each period of play. Should the sound device fail to sound automatically when time expires, the determining factor as to whether or not the period has ended shall be the timing device.

Behind each goal, electrical lights shall be set up for the use of the Goal Judges. A red light will signify the scoring of a goal and a green light will signify the end of a period or a game.

A goal cannot be scored when a green light is showing.

A light, normally red in color, will be situated at or near the Timekeeper's Bench and will be illuminated when a commercial time-out is in progress. This light will be extinguished when the commercial time-out is complete to indicate to the teams and the officials that play may resume. This light is controlled by an authorized National Hockey League Commercial Coordinator.

- 4.2 **Timing Devices** - Each rink shall be provided with some form of electronic clock for the purpose of keeping the spectators, players and game officials accurately informed as to all time elements at all stages of the game including the time remaining to be played in any period and the time remaining to be served by at least five penalized players on each Team.

Time recording for both game time and penalty time shall show time remaining to be played or served.

The game time clock shall measure the time remaining in tenths of a second during the last minutes of each period.



## SECTION 2 - TEAMS

### Rule 5 – Team

- 5.1 **Eligible Players** - A team shall be composed of 20 players (18 skaters and two goalkeepers) who shall be under contract to the Club they represent. For the purposes of these playing rules, any reference to “player” shall refer to both skaters and goalkeepers. Any reference to “goalkeeper” shall mean that the section of the rule is specific to goalkeepers.

At the beginning of each game, the Manager or Coach of each team shall list the players who shall be eligible to play in the game. Not more than eighteen (18) skaters and two (2) goalkeepers, shall be permitted. One non-uniformed player shall be permitted on the players’ bench in a coaching capacity. He must be indicated on the Roster Sheet submitted by the Coach to the Referee or Official Scorer prior to the start of the game.

A list of names and numbers of all eligible players must be handed to the Official Scorer before the game, and no change shall be permitted in the list or addition thereto shall be permitted after the commencement of the game.

Prior to the game, if an official (on-ice or off-ice) notices that a player is in uniform but has not been included on the Official Game Report, the Referee shall bring this to the attention of the offending team so that the necessary correction can be made to the Official Game Report (and no penalty is assessed).

- 5.2 **Ineligible Player** - Only players on the list submitted to the Official Scorer before the game may participate in the game. The determining factor when considering whether or not a player is eligible is that the player’s name, and not necessarily the player’s number, must be correctly listed by the Manager or Coach of that team.

If a goal is scored when an ineligible player is on the ice (whether he was involved in the scoring or not), the goal will be disallowed. This only applies to the goal scored at the stoppage of play whereby the player was deemed to be ineligible. All other goals scored previously by the ineligible player’s team (with him on the ice or not) shall be allowed. The ineligible player will be removed from the game and the Club shall not be able to substitute another player from its roster. No additional penalties are to be assessed but a report of the incident must be submitted to the Commissioner. For an ineligible goalkeeper, see 5.3.

- 5.3 **Goalkeeper** - Each team shall be allowed one goalkeeper on the ice at one time. The goalkeeper may be removed and another skater substituted. Such substitute shall not be permitted the privileges of the goalkeeper.

Each team shall have on its bench, or on a chair immediately beside the bench, a substitute goalkeeper who shall, at all times, be fully dressed and equipped ready to play.

Except when both goalkeepers are incapacitated, no skater in the





playing roster in that game shall be permitted to wear the equipment of the goalkeeper.

In regular League and Playoff games, if both listed goalkeepers are incapacitated, that team shall be entitled to dress and play any available goalkeeper who is eligible. This goalkeeper is eligible to sit on the player's bench, in uniform. In the event that the two regular goalkeepers are injured or incapacitated in quick succession, the third goalkeeper shall be provided with a reasonable amount of time to get dressed, in addition to a two-minute warm-up (except when he enters the game to defend against a penalty shot). If, however, the third goalkeeper is dressed and on the bench when the second goalkeeper becomes incapacitated, the third goalkeeper shall enter the game immediately and no warm-up is permitted.

The recalling of minor league goalkeepers (as a result of suspensions incurred to both goalkeepers under Rule 11 – Goalkeeper's Equipment) to ensure a complete lineup for subsequent games shall be deemed to be an emergency recall and subject to the twenty-three (23) man roster limitations.

- 5.4 **Coaches and Team Personnel** - No one but players in uniform, non-playing team personnel duly registered on the Roster Sheet as the Manager, Coach(es), Trainer, Equipment Manager, etc. shall be permitted to occupy the benches so provided.

One non-uniformed player shall be permitted on the players' bench in a coaching capacity. He must be indicated on the Roster Sheet submitted by the Coach to the Official Scorer prior to the start of the game.

## **Rule 6 – Captain and Alternate Captains**

- 6.1 **Captain** - One Captain shall be appointed by each team, and he alone shall have the privilege of discussing with the Referee any questions relating to interpretation of rules which may arise during the progress of a game. He shall wear the letter "C," approximately three inches (3") in height and in contrasting color, in a conspicuous position on the front of his sweater. No co-Captains are permitted. Either one Captain and no more than two Alternate Captains, or no Captain and no more than three Alternate Captains are permitted (see 6.2).

Only the Captain, when invited to do so by the Referee, shall have the privilege of discussing any point relating to the interpretation of rules. Any Captain, Alternate Captain or any player who comes off the bench and makes any protest or intervention with the officials for any purpose shall be assessed a minor penalty for unsportsmanlike conduct under Rule 40 – Abuse of Officials. Should this protest continue, he may be assessed a misconduct penalty, and if it further continues, a game misconduct penalty shall be warranted.

A complaint about a penalty is NOT a matter "relating to the interpretation of the rules" and a minor penalty shall be imposed against any Captain, Alternate Captain or any other player making



such a complaint.

The Referee and Official Scorer shall be advised, prior to the start of each game, the name of the Captain and the Alternate Captains of both teams.

No playing Coach or playing Manager or goalkeeper shall be permitted to act as Captain or Alternate Captain.

- 6.2 **Alternate Captains** – If the permanent Captain is not on the ice, Alternate Captains (not more than two) shall be accorded the privileges of the Captain. Alternate Captains shall wear the letter “A” approximately three inches (3”) in height and in contrasting color, in a conspicuous position on the front of their sweaters.

Only when the Captain is not in uniform, the Coach shall have the right to designate three Alternate Captains. This must be done prior to the start of the game.

## **Rule 7 – Starting Line-up**

- 7.1 **Starting Line-up** - Prior to the start of the game, at the request of the Referee, the Manager or Coach of the visiting team is required to name the starting line-up to the Referee or Official Scorer.

Prior to the start of the game, the Manager or Coach of the home team, having been advised by the Official Scorer the names of the starting line-up of the visiting team, shall name the starting line-up of the home team. This information shall be conveyed by the Official Scorer to the Coach of the visiting team.

No change in the starting line-up of either team as given to the Official Scorer, or in the playing line-up on the ice, unless reviewed and approved by the Referee prior to the start of the game.

- 7.2 **Violation** - For an infraction of this rule, a bench minor penalty shall be imposed upon the offending team, provided such infraction is called to the attention of the Referee before the second face-off in the first period takes place. This is an appeal play and must be brought to the Referee’s attention prior to the second face-off in the game. There is no penalty to the requesting team if their appeal is unsustainable. The determining factor when considering whether or not a player or goalkeeper is listed in the starting line-up is that the player or goalkeeper’s name, and not necessarily the player or goalkeeper’s number, must be correctly listed by the Manager or Coach of that team.

In the event a team scores on the first shift of the game, and it is brought to the attention of the Referee by the opposing team that the team that scored did not have the correct starting line-up on the ice, the goal shall be allowed and a bench minor penalty assessed to the offending team for having an improper starting line-up. If the team that scores the goal on the first shift of the game challenges the starting line-up of the opposing team and the opposing team did not have the correct starting line-up, the scoring of the goal would nullify the bench minor penalty and no further penalties would be assessed.



## **Rule 8 – Injured Players**

8.1 **Injured Player** - When a player is injured or compelled to leave the ice during a game, he may retire from the game and be replaced by a substitute, but play must continue without the teams leaving the ice.

During the play, if an injured player wishes to retire from the ice and be replaced by a substitute, he must do so at the players' bench and not through any other exit leading from the rink. This is not a legal player change and therefore when a violation occurs, a bench minor penalty shall be imposed.

If a penalized player has been injured, he may proceed to the dressing room without the necessity of taking a seat on the penalty bench. If the injured player receives a minor penalty, the penalized team shall immediately put a substitute player on the penalty bench, who shall serve the penalty until such time as the injured player is able to return to the game. He would replace his teammate on the penalty bench at the next stoppage of play. If the injured player receives a major penalty, the penalized team shall place a substitute player on the penalty bench before the penalty expires and no other replacement for the penalized player shall be permitted to enter the game except from the penalty bench. For violation of this rule, a bench minor penalty shall be imposed.

Should the injured penalized player who has been replaced on the penalty bench return to his players' bench prior to the expiration of his penalty, he shall not be eligible to play until his penalty has expired. This includes coincidental penalties when his substitute is still in the penalty box awaiting a stoppage in play. The injured player must wait until his substitute has been released from the penalty box before he is eligible to play. If, however, there is a stoppage of play prior to the expiration of his penalty, he must then replace his teammate on the penalty bench and return to play once his penalty has expired.

When a player is injured so that he cannot continue play or go to his bench, the play shall not be stopped until the injured player's team has secured possession of the puck. If the player's team is in possession of the puck at the time of injury, play shall be stopped immediately unless his team is in a scoring position.

In the case where it is obvious that a player has sustained a serious injury, the Referee and/or Linesman may stop the play immediately.

When play has been stopped by the Referee or Linesman due to an injured player, or whenever an injured player is attended to on the ice by the Trainer or medical personnel, such player must be substituted for immediately. This injured player cannot return to the ice until play has resumed.

When play is stopped for an injured player, the ensuing face-off shall be conducted at the face-off spot in the zone nearest the location of the puck when the play was stopped. When the injured player's team has possession of the puck in the attacking zone, the face-off shall be conducted at one of the face-off spots outside the blue line in



the neutral zone. When the injured player is in his defending zone and the attacking team is in possession of the puck in the attacking zone, the face-off shall be conducted at one of the defending team's end-zone face-off spots.

- 8.2 **Injured Goalkeeper** - If a goalkeeper sustains an injury or becomes ill, he must be ready to resume play immediately or be replaced by a substitute goalkeeper and no additional time shall be allowed by the Referee for the purpose of enabling the injured or ill goalkeeper to resume his position. The substitute goalkeeper shall be allowed a two (2) minute warm-up during all pre-season games. No warm-up shall be permitted for a substitute goalkeeper in all regular League or Playoff games.

The Referee shall report to the Commissioner for disciplinary action any delay in making a goalkeeper substitution.

The substitute goalkeeper shall be subject to the regular rules governing goalkeepers and shall be entitled to the same privileges.

When a substitution for the regular goalkeeper has been made, such regular goalkeeper shall not resume his position until the next stoppage of play.

When play has been stopped by the Referee or Linesman due to an injured goalkeeper, such goalkeeper must be substituted for only if he has to proceed to the players' bench to receive medical attention. If the Trainer has come onto the ice to attend to the goalkeeper and there is no undue delay, the goalkeeper may remain in the game without substitute. However, no additional time shall be permitted by the Referee for the purpose of enabling the injured goalkeeper to resume his position (i.e. no warm-up).

- 8.3 **Blood** – A player who is bleeding or who has visible blood on his equipment or body shall be ruled off the ice at the next stoppage of play. Such player shall not be permitted to return to play until the bleeding has been stopped and the cut or abrasion covered (if necessary). It is required that any affected equipment and/or uniform be properly decontaminated or exchanged.



## SECTION 3 – EQUIPMENT

### Rule 9 – Uniforms

9.1 **Team Uniform** – All players of each team shall be dressed uniformly with approved design and color of their helmets, sweaters, short pants, stockings and skates.

Altered uniforms of any kind, i.e. Velcro inserts, over-sized jerseys, altered collars, etc., will not be permitted. Any player or goalkeeper not complying with this rule shall not be permitted to participate in the game. For violations, refer to 9.5.

Each member Club shall design and wear distinctive and contrasting uniforms for their home and road games, no parts of which shall be interchangeable except the pants. Any concerns regarding a player's uniform (including the goalkeeper) shall be reported by the Referee to the NHL Hockey Operations Department.

9.2 **Numbers** - Each player listed in the line-up of each team shall wear an individual identifying number at least ten inches (10") high on the back of his sweater. Sweater numbers such as 00, ½ (fractions), .05 (decimals), 101 (three digit) are not permitted. In addition, each player shall wear his surname in full, in block letters three inches (3") high, across the back of his sweater at shoulder height.

9.3 **Player's Jersey** – (see 9.4 for goalkeeper) The maximum jersey size is (see diagram).

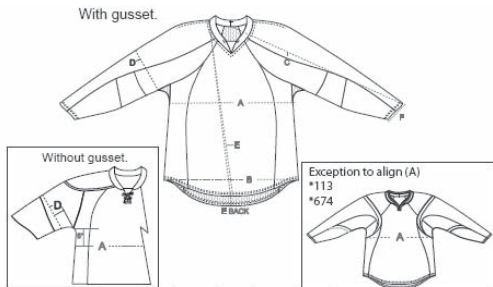

	46	48	50	52	54	56	58	58+ 60	TOLERANCES
A	22 1/4	23 1/4	24 1/4	25 1/4	26 1/4	27 1/4	28 1/4	29 1/4	+/- 3/4
A Without gusset.	21 1/2	22 1/2	23 1/2	24 1/2	25 1/2	26 1/2	27 1/2	28 1/2	+/- 3/4
(A) 874	23	24 1/4	25 1/4	26 1/4	27 1/4	28 1/4	29 1/4	30 1/4	+/- 3/4
(A) 113	24 5/8	25 1/8	25 3/4	26 5/8	27 3/8	28	28 5/8	29 1/4	+/- 3/4
B	23 1/2	24 1/2	25 1/2	26 1/2	27 1/2	28 1/2	29 1/2	30 1/2	+/- 3/4
C Average(see note)	31 1/2	32 1/4	33	33 3/4	34 1/4	34 3/4	35 1/4	35 3/4	+/- 3/4
D	10 3/4	11	11 1/4	11 1/2	11 3/4	12	12 1/4	12 1/2	+/- 3/4
E Average(see note)	31 1/4	31 1/2	31 3/4	32 1/2	32 3/4	33	33 1/4	34	+/- 3/4
E DOS Average(see note)	32 3/4	33	33 1/4	34	34 1/4	34 1/2	34 3/4	35 1/2	+/- 3/4
E 103 Average(see note)	30 1/4	30 1/2	30 3/4	31 1/2	31 3/4	32	32 1/4	33	+/- 3/4
E DOS 103C Average(see note)	31 1/4	31 1/2	31 3/4	32 1/2	32 3/4	33	33 1/4	34	+/- 3/4
F	7 3/8	7 3/8	7 3/8	6 7/8	7 3/8	7 3/8	7 3/8	7 3/8	+/- 1/2

\* C,E and D are average measurement from sampling. Use for reference only . There are not pattern measurement.



No inserts or additions are to be added to the standard players' jersey as produced by the manufacturer. (Modifications at the manufacturer are not allowed unless approved in advance by the League)

No alteration of the neck opening is permitted.

Sleeves must extend into the cuff of the glove.

Jerseys must be "tied down" properly at all times.

#### 9.4 Goalkeeper's Jersey – The maximum jersey size is (see diagram).

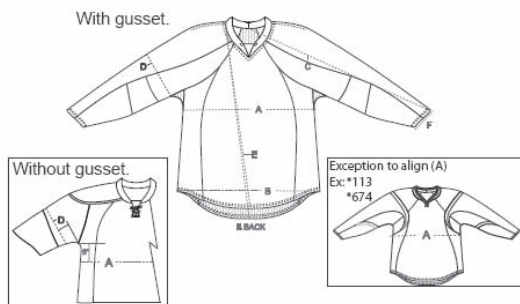

	54	56	58	58- 60	TOLERANCES
A	28 1/2	29 1/2	30 1/2	31 1/2	+/- 3/4
A without gusset	28 7/8	29 7/8	30 7/8	31 7/8	+/- 3/4
(A) 113,674	29 1/4	30 1/4	31 1/4	32 1/4	+/- 3/4
B	28 1/2	29 1/2	30 1/2	31 1/2	+/- 3/4
C Average(see note)	34	34 1/2	35	35 1/2	+/- 3/4
D	15	15 1/4	15 1/2	15 3/4	+/- 3/4
E Average(see note)	31 3/4	32	32 1/4	33	+/- 3/4
E BACK Average(see note)	35 3/4	36	36 1/4	37	+/- 3/4
E BACK 103C Average(see note)	34 1/4	34 1/2	34 3/4	35 1/2	+/- 3/4
F	8 3/4	8 3/4	8 3/4	8 3/4	+/- 1/2

\* C,E are average measurement from sampling. Use for reference only . There are not pattern measurement.

No inserts or additions are to be added to the standard goalkeeper-cut jersey as produced by the manufacturer. Modifications at the manufacturer are not allowed unless approved in advance by the League.

No "tying down" of the sweater is allowed at the wrists if it creates a tension across the jersey such that a "webbing effect" is created in the armpit area.

No other tie downs are allowed that create a "webbing effect."

The length of a jersey is illegal if it covers any area between the goalkeeper's legs.

#### 9.5 Protective Equipment - All protective equipment, except gloves, headgear and goalkeepers' leg guards must be worn under the uniform. Should it be brought to the attention of the Referee that a



player is wearing, for example, an elbow pad that is not covered by his jersey, he shall instruct the player to cover up the pad and a second violation by the same player would result in a minor penalty being assessed.

All players of both teams shall wear a helmet of design, material and construction approved by the League at all times while participating in a game, either on the playing surface or the players' or penalty benches.

A player may continue to participate in the play without his helmet. However, if he goes to his players' bench to be substituted for, he may not return to the ice during play without a helmet (nor may a player exit the penalty bench during play without a helmet). Should he do so, the play shall be stopped once his team has gained possession of the puck. If the play is stopped for such an infraction in the attacking zone, the ensuing face-off will take place at the nearest face-off spot in the neutral zone of the non-offending team. If the play is stopped for such an infraction in the defending or neutral zone, the ensuing face-off will take place at the nearest face-off spot to the location of the puck in that zone when the play was stopped.

When a goalkeeper has lost his helmet and/or face mask and his team has possession of the puck, the play shall be stopped immediately to allow the goalkeeper the opportunity to regain his helmet and/or face mask. When the opposing team has possession of the puck, play shall only be stopped if there is no immediate and impending scoring opportunity. This stoppage of play must be made by the Referee. When play is stopped because the goalkeeper has lost his helmet and/or face mask, the ensuing face-off shall take place at one of the defending team's end zone face-off spots.

When a goalkeeper deliberately removes his helmet and/or face mask in order to secure a stoppage of play, the Referee shall stop play as outlined above and in this case assess the goalkeeper a minor penalty for delaying the game. If the goalkeeper deliberately removes his helmet and/or face mask when the opposing team is on a breakaway, the Referee shall award a penalty shot to the non-offending team, which shot shall be taken by the player last in possession of the puck. If the goalkeeper deliberately removes his helmet and/or face mask during the course of a penalty shot or shootout attempt, the Referee shall award a goal to the non-offending team.

Whenever it is deemed by the Referee that a player is wearing protective equipment (including an altered or torn jersey) that does not meet with League regulations, he shall instruct the player to change or remove the piece of equipment. If he refuses to make the necessary change he shall be assessed a minor penalty for delay of game and should he return to the ice without making the necessary change he shall be assessed a misconduct penalty. Should this happen a third time, he shall be assessed a game misconduct penalty.

#### 9.6 **Dangerous Equipment** - The use of pads or protectors made of



metal, or of any other material likely to cause injury to a player is prohibited. Referees have the authority to prohibit any equipment they feel may cause injury to any participants in the game. Failure to comply with the Referees' instructions shall result in the assessment of a minor penalty for delay of game.

A mask or protector of a design approved by the League may be worn by a player who has sustained a facial injury.

In the first instance, the injured player shall be entitled to wear any protective device prescribed by the Club doctor. If any opposing Club objects to the device, it may record its objection with the Commissioner.

In cases where a stick may have been modified and it is evident that the edges have not been beveled, the Referee shall deem the stick to be dangerous equipment and removed from the game until the edges can be beveled sufficiently. No penalty is to be assessed initially unless the player returns to the ice with the unmodified stick, for which he will be assessed a minor penalty for delay of game.

## **Rule 10 – Sticks**

**10.1 Player's Stick** – (see 10.2 for goalkeeper) The sticks shall be made of wood or other material approved by the League, and must not have any projections. Adhesive tape of any color may be wrapped around the stick at any place for the purpose of reinforcement or to improve control of the puck.

No stick shall exceed sixty-three inches (63") in length from the heel to the end of the shaft nor more than twelve and one-half inches (12½") from the heel to the end of the blade.

Requests for an exception to the length of the shaft (only) may be submitted in writing to and must be approved by the League's Hockey Operations Department prior to any such stick being approved for use. Maximum length of a stick granted an exception under this rule is sixty-five inches (65").

The blade of the stick shall not be more than three inches (3") in width at any point between the heel and ½" in from the mid-point of the tip of the blade, nor less than two inches (2"). All edges of the blade shall be beveled (see 9.6). The curvature of the blade of the stick shall be restricted in such a way that the distance of a perpendicular line measured from a straight line drawn from any point at the heel to the end of the blade to the point of maximum curvature shall not exceed three-quarters of an inch (¾").



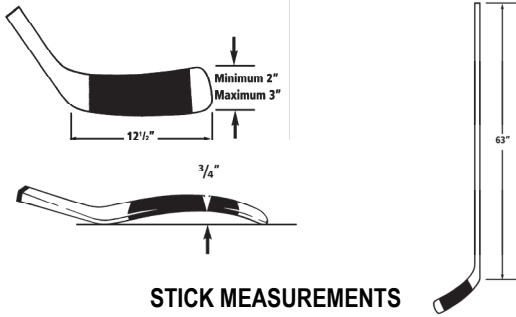

### STICK MEASUREMENTS

- 10.2 **Goalkeeper's Stick** - In the case of a goalkeeper's stick, there shall be a knob of white tape or some other protective material approved by the League. This knob must not be less than one-half inch ( $1/2$ " ) thick at the top of the shaft.

Failure to comply with this provision of the rule will result in the goalkeeper's stick being deemed unfit for play. The goalkeeper's stick must be changed without the application of a minor penalty.

The blade of the goalkeeper's stick shall not exceed three and one-half inches ( $3\frac{1}{2}$ " ) in width at any point except at the heel, where it must not exceed four and one-half inches ( $4\frac{1}{2}$ " ) in width; nor shall the goalkeeper's stick exceed fifteen and one-half inches ( $15\frac{1}{2}$ " ) in length from the heel to the end of the blade.

There is to be no measurement of any of the dimensions of the goalkeeper's stick during the course of the game. The League's Hockey Operations Department is specifically authorized to make a check of all goalkeepers' sticks to ensure the compliance with the rule. It shall report its findings to the Commissioner for his disciplinary action (see 11.8).

The widened portion of the goalkeeper's stick extending up the shaft from the blade shall not extend more than twenty-six inches (26" ) from the heel and shall not exceed three and one-half inches ( $3\frac{1}{2}$ " ) in width.

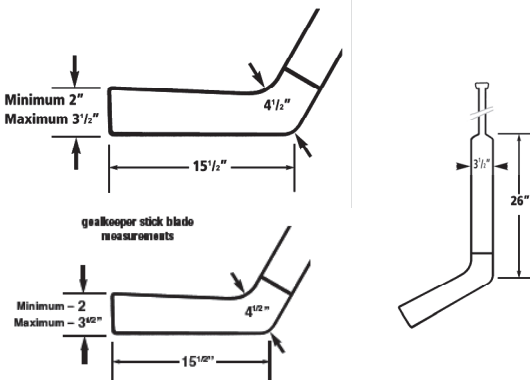

### GOALKEEPERS' STICK MEASUREMENTS



- 10.3 **Broken Stick – Player** - A broken stick is one which, in the opinion of the Referee, is unfit for normal play.

A player without a stick may participate in the game. A player whose stick is broken may participate in the game provided he drops the broken stick. A minor penalty shall be imposed for an infraction of this rule.

A player who has lost or broken his stick may only receive a stick at his own players' bench or be handed one from a teammate on the ice. A player will be penalized if he throws, tosses, slides or shoots a stick to a teammate on the ice. A player may not participate in the play using a goalkeeper's stick. A minor penalty shall be imposed for an infraction of this rule.

A player tendered a stick thrown on the ice from the players' or penalty bench will not receive a penalty. However, the person responsible for throwing the stick will receive a bench minor penalty.

- 10.4 **Broken Stick – Goalkeeper** - A goalkeeper may continue to play with a broken stick until a stoppage of play or until he has one legally handed to him by a teammate. The teammate must hand the stick to him. He cannot throw it or slide it to the goalkeeper (this includes situations where the goalkeeper has lost his stick and a teammate is trying to return it to him). For a violation of this rule, a minor penalty for throwing the stick shall be assessed to the offending player (no penalty to the goalkeeper for receiving the stick).

A goalkeeper whose stick is broken or illegal may not go to the players' bench for a replacement but must receive his stick from a teammate. A goalkeeper may participate in the play using a skater's stick until such time as he is legally provided with a replacement goalkeeper's stick.

For an infraction of this rule, a minor penalty shall be imposed on the goalkeeper.

- 10.5 **Stick Measurement** - A request for a stick measurement shall be limited to one request per team during the course of any stoppage in play.

When a formal complaint is made by the Captain or Alternate Captain of a team, against the dimensions of any stick of an opponent, that opponent must be on the ice at the time the request is made to the Referee. Once the request is made, and as long as the Officials maintain visual contact with the stick, it can be measured. This means that if the player whose stick is about to be measured steps off the ice onto his players' bench, his stick may still be measured provided the request was received prior to him leaving the ice surface and the stick remains in the view of at least one of the on-ice Officials.

The Referee shall take the stick to the penalty bench where the necessary measurement shall be made immediately. Players on both teams shall retire to their respective benches. To measure the



curvature of the blade of the stick, the Referee must draw an imaginary line along the outside of the shaft to the bottom of the blade and then along the bottom of the blade - this will determine the location of the heel. Using a League-approved measuring gauge, the Referee shall secure the gauge at the heel of the stick and measure the curvature of the blade from the heel to any point along the toe of the blade. To measure any other dimension of the stick, the Referee shall use a measuring tape.

The result shall be reported to the Penalty Timekeeper, who shall record it on the back of the Penalty Record form. The Referee will convey the result of the measurement to Captain or Alternate Captain of the player whose stick was measured. If the stick proves to be illegal, the stick shall remain at the penalty bench until the end of the game.

A player whose stick has been measured and it is found not to conform to the provisions of this rule shall be assessed a minor penalty and a fine of two hundred dollars (\$200). For a second offense in the same season, the player shall (in addition to the minor penalty) be fined one thousand dollars (\$1000). For a third offense in the same season, the player shall (in addition to the minor penalty) be assessed a game misconduct and an automatic one game suspension. For all additional violations in the same season, the automatic suspension to the player shall (in addition to the minor penalty and game misconduct assessed during the game) double for each subsequent violation of this rule (i.e. first suspension - one game, second suspension - two games, third suspension - four games etc.)

If the complaint is not sustained, a bench minor penalty shall be imposed against the complaining Club in addition to a fine of one hundred dollars (\$100).

A player who participates in the play, who checks or who intentionally prevents the movement of an opponent, or who intentionally plays the puck while carrying two sticks (including while taking a replacement stick to his goalkeeper) shall incur a minor penalty under this rule but the automatic fine of two hundred dollars (\$200) shall not be imposed. If his participation causes a foul resulting in a penalty, the Referee shall report the incident to the Commissioner for disciplinary action.

A request for a stick measurement in regular playing time is permitted, including after the scoring of a goal, however, a goal cannot be disallowed as a result of the measurement. A request for a stick measurement following a goal in overtime (including one scored on a penalty shot in overtime) is not permitted. Stick measurements prior to or during the shootout are permitted, subject to the guidelines outlined in 10.7.

Any player who deliberately breaks his stick or who refuses to surrender his stick for measurement when requested to do so by the Referee shall be assessed a minor penalty plus a ten-minute (10) misconduct. In addition, this player or goalkeeper shall be subject to a



two hundred dollar (\$200) fine.

If, after a player's stick has been ruled illegal, he attempts to take a penalty shot with a second stick that is also ruled illegal prior to taking the penalty shot, the opportunity to take the penalty shot shall be disallowed. The player shall be assessed one minor penalty for the first illegal stick.

- 10.6 Stick Measurement – Prior to Penalty Shot** – A stick measurement request may be made prior to a penalty shot following the guidelines below:

#### First Stick

If the stick is "legal" the complaining Club is assessed a bench minor penalty, a player is placed in the penalty box immediately. Regardless as to the result of the penalty shot, the bench minor penalty is assessed and served.

If the stick is "illegal" the player will be assessed a minor penalty. He will be ordered to obtain a new (second) stick prior to the penalty shot. After he takes the shot he will be required to serve his penalty.

#### Second stick

The player will be told that the second stick will be measured prior to the penalty shot to verify the legality of the stick.

If the second stick is "legal", proceed with the penalty shot.

If second stick is "illegal", disallow the opportunity for the penalty shot and assess one minor penalty for the first illegal stick.

If the player refuses to surrender his stick for measurement prior to the penalty shot, the penalty shot shall not be permitted and the player shall be assessed a misconduct penalty.

- 10.7 Stick Measurement – Prior to Shootout Attempt** – A stick measurement request must be made prior to the Referee blowing his whistle to begin the shootout attempt.

If the stick is "legal" the complaining Club forfeits their next shootout attempt. In addition, the complaining Club's Coach shall be fined one thousand dollars (\$1000) and the Club shall be fined five thousand dollars (\$5000). Should this occur during the first set of three shooters, the next shooter listed becomes ineligible to shoot until such time as all eligible players have participated in the shootout. Their next shootout attempt would be recorded as "no goal".

If the stick is "illegal", the offending team forfeits that shootout attempt by that player, and the player becomes ineligible to participate in the shootout. In addition, the player is fined one thousand dollars (\$1000) and his Club is fined five thousand dollars (\$5000). This shootout attempt would be recorded as "no goal".

Stick measurement violations during the shootout shall not be subject to the fines and suspensions outlined in **10.5**.



## **Rule 11 – Goalkeeper’s Equipment**

- 11.1 **Goalkeeper’s Equipment** - With the exception of skates and stick, all the equipment worn by the goalkeeper must be constructed solely for the purpose of protecting the head or body, and he must not wear any garment or use any contrivance which would give him undue assistance in keeping goal.

The League’s Hockey Operations Department is specifically authorized to make a check of each teams’ equipment (including goalkeepers’ sticks) to ensure the compliance with the rule. It shall report its findings to the Commissioner for his disciplinary action.

- 11.2 **Leg Guards** – The leg guards worn by goalkeepers shall not exceed eleven inches (11") in extreme width when on the leg of the player. The maximum length from bottom mid-point to top mid-point of the pad is not to exceed thirty-eight inches (38"). The minimum length of the boot of the pad is to be no less than seven inches (7"). The goal pad must have a defined boot channel with no inserts. The channel must be big enough so that the skate slots into it and is not resting on the pad. No attachments such as plastic puck foils are permitted. Pads can only be ten and one-half inches (10½") deep. The measurement will be taken from the front face of the pad to the last edge of the inner knee protection.

Calf-wing protectors can no longer be attached to the five-hole or the five-hole seam. Calf-wings must be inset one-half inch (½") from the inside five-hole, creating a distinct edge, and attached to the back cover. Calf-wing protectors must be one piece and cannot include wedges (removable or non-removable). Calf-wing protectors may be flat for five and one-half inches (5½") before contouring to the shape of the leg. Calf-wing protectors must contour and cannot be visible to the shooter when strapped to the goalkeeper’s leg. Calf-wing protectors may not exceed one inch (1") in thickness. Calf-wing protector straps must run through or wrap around so the calf protector follows the contour of the goalkeeper’s leg even if the straps are worn loosely. No zippers, Velcro, or Velcro attachments are allowed.

The knee strap pad is not to exceed six inches (6") in length by five and one-half inches (5½") in width. The knee strap pad must be fastened to the inner risers/lifts. The inner knee risers are not to exceed seven inches (7") in length by five and one-half inches (5½") in width. The length of seven inches (7") is measured from where the inner padding attaches to the leg pad and back to the end of the inner padding. The total measurement of the entire inner knee padding (pad risers) including the outer knee strap pad must not exceed two and one-half inches (2½") in thickness and will be measured when non-compressed. Knee strap pads and riser/lifts must have a one inch (1") radius (rounded) on the top edge. Knee straps must wrap around the knee build-ups and cannot come out behind or through knee build-ups. Medial rolls (raised seam ridges) will not be permitted. All knee protection attached to the leg pad must be worn under the thigh guard of the pant.



- 11.3 **Chest and Arm Pads** – No raised ridges are allowed on the front edges or sides of the chest pad, the inside or outside of the arms, or across the shoulders.

Layering at the elbow is permitted to add protection but not to add stopping area. This layering, both across the front and down the sides, to protect the point of the elbow shall not exceed seven inches (7").

Shoulder cap protectors must follow the contour of the shoulder cap without becoming a projection/extension beyond or above the shoulder or shoulder cap. This contoured padding must not be more than one inch (1") in thickness beyond the top ridge of the shoulder and shoulder cap.

On each side the shoulder clavicle protectors are not to exceed seven inches (7") in width. Their maximum thickness is to be one inch (1"). This protection is not to extend or project above or beyond the shoulder or shoulder cap nor extend beyond the armpit. No insert is allowed between the shoulder clavicle protector and the chest pad that would elevate the shoulder clavicle protector.

If, when the goalkeeper assumes his normal crouch position, the shoulder and/or shoulder cap protection is pushed above the contour of the shoulder, the chest pad will be considered illegal.

The chest and arm protector worn by each goalkeeper must be anatomically proportional and size specific based on the individual physical characteristics of that goalkeeper. The League's Hockey Operations Department will have the complete discretion to determine the maximum size for each goalkeeper's chest and arm protector based on measurements obtained by the League's Hockey Operations Department, which will include but not be limited to, measurements for torso and arm length. Any chest and arm protector deemed too large for a goalkeeper will be considered illegal equipment for that goalkeeper, regardless of whether or not it would have fallen within previous equipment maximums.

- 11.4 **Pants** – No internal or external or cheater padding is permitted on the pant leg or waist beyond that which is required to provide protection (no outside or inside ridges).

The maximum width (straight line) of the thigh pad across the front of the leg is ten inches (10"). If the groin and/or hip pads extend beyond the edge of the front thigh pad they are to be included in this ten-inch (10") measurement. This measurement is to be taken while the goalkeeper is in an upright standing position. This measurement is to be made five inches (5") up from the bottom of the pant.

All thigh pads must follow the contour of the leg. Square thigh pads are considered illegal.

All knee protection must be strapped and fit under the thigh pad of the pant leg and not exceed a contoured ten inches (10"), with no flat surfaces and must not be permanently attached or fixed to the pants.

Each goalkeeper must wear pants that are anatomically

proportional and size specific based on the individual physical characteristics of that goalkeeper. The League's Hockey Operations Department will have the complete discretion to determine the maximum size of each goalkeeper's pants based on measurements obtained by the League's Hockey Operations Department, which will include but not be limited to, measurements for waist circumference and length of pant above and below waist line. In determining pants sizes, whether or not a goalkeeper wears his chest and arm pads inside or outside of his pants will also be a consideration. Any pants deemed too large for a goalkeeper will be considered illegal equipment for that goalkeeper, regardless of whether or not they would have fallen within previous equipment maximums.

- 11.5 **Catching Glove** – A maximum perimeter of forty-five inches (45") is permitted. The perimeter of the glove is the distance around the glove (see measurement procedures below).

The wrist cuff must be four inches (4") in width. The cuff of the glove is considered to be the portion of the glove protecting the wrist from the point where the thumb joint meets the wrist. Any protection joining/enhancing the cuff to the glove will be considered part of the glove rather than the cuff.

The wrist cuff is to be a maximum of eight inches (8") in length (this includes the bindings). All measurements follow the contour of the cuff.

The distance from the heel of the glove along the pocket and following the contour of the inside of the trap of the glove to the top of the "T" trap must not exceed eighteen inches (18"). The heel is considered to be the point at which the straight vertical line from the cuff meets the glove (see diagram at right).

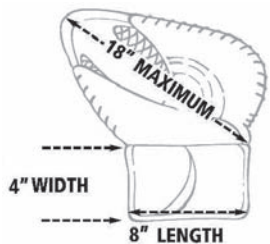

**Measuring Procedures for Goalkeepers' Catching Glove**

Suggested Equipment - binder clip, pins and a 5/8" fiberglass cloth measuring tape that measures eighth of an inch.

Procedure:

- 1) At the "starting point" of the measurement, anchor the tape with a pin or binder clip.
- 2) Ensure that the midpoint line of the measuring tape follows the outside top ridge of the edge/binding.

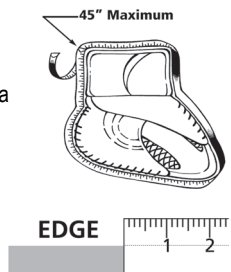



- 3) If at the junction of the cuff and catch portions of the glove there is a "jagged point," the measurement tape will follow the imaginary perpendicular line to the glove ridge above. (A "jagged joint" anywhere else on the glove will not be allowed this "straight line" privilege, i.e. where the trap joins the main glove).

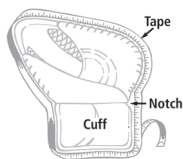

- 11.6 **Blocking Glove** – Protective padding attached to the back or forming part of the goalkeeper's blocking glove shall not exceed eight inches (8") in width nor more than fifteen inches (15") in length at any point (this includes the bindings). All measurements follow the contour of the back of the glove.

The blocking glove must be rectangular in shape.

The flap protecting the thumb and wrist must be fastened to the blocker and must follow the contour of the thumb and wrist. This thumb protection must not exceed seven inches (7") in extreme length when measured from the top of the blocking surface.

Raised ridges are not to be added to any portion of the blocking glove.

All goalkeepers must use one of each a blocking glove and catching glove, meeting League-approved sizing specifications.

- 11.7 **Masks** – Protective masks of a design approved by the League may be worn by goalkeepers. Protective masks deemed to be worn only to increase stopping area will be considered illegal.

- 11.8 **League Inspections** - These inspections can take place any time, before, during, or after the game. A member of the League's Hockey Operations, Officiating and/or Security departments may obtain the equipment from any or all four participating goalkeepers. This equipment may be removed to a secure location for measuring.

Any violation of this rule will result in an automatic two (2) game suspension for the next League game to the offending goalkeeper. Should both goalkeepers on a Club have illegal equipment, both will be suspended in sequence. The goalkeeper who played the day/night of the measurement will be suspended for the next two (2) games, and the back-up goalkeeper will be suspended for the following two (2) games.

A goalkeeper who plays with equipment that has not been inspected and approved by the League's Hockey Operations Department, or who tampers with equipment after it has been inspected and approved by the League's Hockey Operations, Officiating and or Security departments will be suspended for the next two (2) League games, his Club will be fined \$25,000.00 and his Equipment Manager will be fined \$1000.00 (to be deducted from his pay), regardless of whether or not such equipment previously





complied with League standards. Each additional violation will result in all game suspensions and fines being doubled.

Refusal to submit the equipment for League measurement will result in the same sanctions as those imposed on a goalkeeper with illegal equipment.

Any violation of this rule shall be reported to the Club involved and to the Commissioner of the League.

## **Rule 12 – Illegal Equipment**

- 12.1 **Illegal Equipment** - All protective equipment, except gloves, headgear and goalkeepers' leg guards must be worn under the uniform. For violation of this rule, after warning by the Referee, a minor penalty shall be imposed.

Players violating this rule shall not be permitted to participate in the game until such equipment has been corrected or removed.

- 12.2 **Gloves** - A glove from which all or part of the palm has been removed or cut to permit the use of the bare hand shall be considered illegal equipment and if any player wears such a glove in play, a minor penalty shall be imposed on him.

When a complaint is made under this rule, and such complaint is not sustained, a bench minor penalty shall be imposed against the complaining Club for delaying the game.

- 12.3 **Elbow Pads** - All elbow pads which do not have a soft protective outer covering of sponge rubber or similar material at least one-half inch ( $1/2$ " ) thick shall be considered dangerous equipment.
- 12.4 **Fair Play** - These equipment regulations (Section 3) are written in the spirit of "fair play." If at any time the League feels that this spirit is being abused, the offending equipment will be deemed ineligible for play until a hearing has ruled on its eligibility.
- 12.5 **League Inspections** - The League's Hockey Operations, Officiating and/or Security departments are specifically authorized to make a check of each team's equipment to ensure the compliance with this rule. They shall report their findings to the Commissioner for his disciplinary action.

## **Rule 13 - Puck**

- 13.1 **Dimensions** - The puck shall be made of vulcanized rubber, or other approved material, one inch (1") thick and three inches (3") in diameter and shall weigh between five and one-half ounces ( $5\frac{1}{2}$ " oz.) and six ounces (6 oz.). All pucks used in competition must be approved by the League.
- 13.2 **Supply** - The home team shall be responsible for providing an adequate supply of official pucks which shall be kept in a frozen



condition. This supply of pucks shall be kept at the penalty bench under the control of one of the regular off-ice Officials or a special attendant.

- 13.3 **Illegal Puck** - If at any time while play is in progress, a puck other than the one legally in play shall appear on the playing surface, the play shall not be stopped but shall continue with the legal puck until the play then in progress is completed by change of possession.

## **Rule 14 – Adjustment to Clothing or Equipment**

- 14.1 **Adjustment to Clothing or Equipment** - Play shall not be stopped nor the game delayed by reasons of adjustments to clothing, equipment, skates or sticks.

The onus of maintaining clothing and equipment in proper condition shall be upon the player. If adjustments are required, the player shall leave the ice and play shall continue with a substitute.

No delay shall be permitted for the repair or adjustment of goalkeeper's equipment. If adjustments are required, the goalkeeper shall leave the ice and his place shall be taken by the substitute goalkeeper immediately.



## SECTION 4 – TYPES OF PENALTIES

### Rule 15 – Calling of Penalties

- 15.1 **Calling a Penalty** - Should an infraction of the rules which would call for a minor, major, misconduct, game misconduct or match penalty be committed by a player of the side in possession of the puck, the Referee shall immediately blow his whistle and penalize the offending player.

Should an infraction of the rules which would call for a minor, major, misconduct, game misconduct or match penalty be committed by a player of the team not in possession of the puck, the Referee shall raise his arm to signal the delayed calling of a penalty. When the team to be penalized gains control of the puck, the Referee will blow his whistle to stop play and impose the penalty on the offending player.

When a player, Trainer, Manager, coach or non-playing Club personnel is ejected from the game for a violation of the playing rules, that individual must vacate the players' bench area and may not, in any manner, further participate in the game. This includes directing the team from the spectator area or by radio communications. Any violations shall be reported to the Commissioner.

Refer to Reference Tables – Table 1 – Summary of Penalties to Coaches and Non-playing Club Personnel (page 131) for a list of infractions specific to those individuals.

- 15.2 **Calling a Minor Penalty – Goal Scored** - If the penalty to be imposed is a minor penalty and a goal is scored on the play by the non-offending side, the minor penalty shall not be imposed but major and match penalties shall be imposed in the normal manner regardless of whether or not a goal is scored.

If two or more minor penalties were to be imposed and a goal is scored on the play by the non-offending side, the Captain of the offending team shall designate to the Referee which minor penalty(ies) will be assessed and which minor penalty will be washed out as a result of the scoring of the goal.

- 15.3 **Calling a Double-minor Penalty – Goal Scored** - When the penalty to be imposed is applicable under Rule 48 for Head-butting or Rule 58 Butt-ending, Rule 60 High-sticking or Rule 62 Sparring, and a goal is scored, two minutes of the appropriate penalty will be assessed to the offending player. (This will be announced as a double-minor for the appropriate foul and the player will serve two (2) minutes only.)
- 15.4 **Calling a Penalty – Short-handed Team – Goal Scored** - If when a team is "short-handed" by reason of one or more minor or bench minor penalties, the Referee signals a further minor penalty or penalties against the "short-handed" team and a goal is scored by the non-offending side before the whistle is blown, then the goal shall be allowed. The penalty or penalties signaled shall be assessed and the first of the minor penalties already being served shall automatically



terminate under Rule 16 – Minor Penalties. Major and match penalties shall be imposed in the normal manner regardless of whether or not a goal is scored.

Should a minor or bench minor penalty be signaled against a team already short-handed by reason of a major (or match) penalty, but before the play can be stopped to assess the minor or bench minor penalty, a goal is scored by the non-offending side, the signaled minor or bench minor penalty shall not be imposed due to the scoring of the goal.

Should a penalty be signaled against a team already short-handed by reason of one or more minor or bench minor penalties, and the signaled penalty would result in the awarding of a penalty shot, but before the Referee can stop play to award the penalty shot, the non-offending team scores a goal, then the signaled penalty (that would have resulted in a penalty shot) shall be assessed as a minor (double-minor, major or match) penalty and the first of the minor penalties already being served shall automatically terminate under Rule 16 – Minor Penalties.

**15.5 Face-off Locations** – When players are penalized at a stoppage of play so as to result in one or more penalties being placed on the penalty time clock to one team, the ensuing face-off shall be conducted at one of the two face-off spots in the offending team's end zone. There are only four (4) exceptions to this application:

- (i) *when a penalty is assessed after the scoring of a goal – face-off at center ice;*
- (ii) *when a penalty is assessed at the end (or start) of a period – face-off at center ice;*
- (iii) *when the defending team is penalized and the attacking players enter the attacking zone beyond the outer edge of the end zone face-off circle – face-off in the neutral zone (see Rule 76.2, paragraph 10);*
- (iv) *when the team not being penalized ices the puck – face-off in the neutral zone outside the blue line of the team icing the puck.*

## **Rule 16 – Minor Penalties**

**16.1 Minor Penalty** - For a minor penalty, any player, other than a goalkeeper, shall be ruled off the ice for two (2) minutes during which time no substitute shall be permitted.

**16.2 Short-handed** - "Short-handed" means that the team must be below the numerical strength of its opponent on the ice at the time the goal is scored. The minor or bench minor penalty which terminates automatically is the one with the least amount of time on the clock. Thus coincident minor penalties to both Teams do not cause either side to be "short-handed" (see Rule 19).

If while a team is "short-handed" by one or more minor or bench minor penalties, the opposing team scores a goal, the first of such penalties shall automatically terminate.



This rule shall also apply when a goal is awarded.

This rule does not apply when a goal is scored on a penalty shot (i.e. offending team's penalized player(s) do not get released on the scoring of a goal on a penalty shot).

**Minor penalty expiration criteria:**

- (i) *Is the team scored against short-handed?*
- (ii) *Is the team scored against serving a minor penalty on the clock?*

If both criteria are satisfied, the minor penalty with the least amount of time on the clock shall terminate except when coincidental penalties are being served. Refer to Reference Tables – Table 16 – Goals Scored Against a Short-handed Team (page 139).

No penalty shall expire when a goal is scored against a team on a penalty shot.

When the minor penalties of two players of the same team terminate at the same time, the Captain of that team shall designate to the Referee which of such players will return to the ice first and the Referee will instruct the Penalty Timekeeper accordingly.

- 16.3 **Infractions** – Refer to Reference Tables – Table 2 – Summary of Minor Penalties (page 131), for a list of infractions that can result in a minor penalty being assessed (see specific rule numbers for complete descriptions).

## **Rule 17 – Bench Minor Penalties**

- 17.1 **Bench Minor Penalty** - A bench minor penalty involves the removal from the ice of one player of the team against which the penalty is assessed for a period of two (2) minutes. Any player except a goalkeeper of the team may be designated to serve the penalty by the Manager or Coach through the playing Captain and such player shall take his place on the penalty bench promptly and serve the penalty as if it was a minor penalty imposed upon him.
- 17.2 **Short-handed** – see 16.2.
- 17.3 **Infractions** – Refer to Reference Tables – Table 3 – Summary of Bench Minor Penalties (page 132) for a list of infractions that can result in a bench minor penalty being assessed (see specific rule numbers for complete descriptions).

## **Rule 18 – Double-minor Penalties**

- 18.1 **Double-minor Penalty** - For a double-minor penalty, any player, other than a goalkeeper, shall be ruled off the ice for four (4) minutes during which time no substitute shall be permitted.
- 18.2 **Short-handed** – see 16.2.

When a double-minor penalty has been signaled by the Referee



and the non-offending team scores during the delay, one of the minor penalties shall be washed out and the penalized player will serve the remaining two minutes of the double-minor penalty. The penalty will be announced as a double-minor penalty but only two minutes would be shown on the penalty time clock.

- 18.3 **Infractions** – Refer to Reference Tables – Table 4 – Summary of Double-minor Penalties (page 133) for a list of infractions that can result in a double-minor penalty being assessed (see specific rule numbers for complete descriptions).

## **Rule 19 – Coincidental Penalties**

- 19.1 **Coincidental Minor Penalties** - When coincident minor penalties or coincident minor penalties of equal duration are imposed against players of both teams, the penalized players shall all take their places on the penalty benches and such penalized players shall not leave the penalty bench until the first stoppage of play following the expiry of their respective penalties. Where goalkeepers are involved, refer to **28.1**. Immediate substitution shall be made for an equal number of minor penalties or coincident minor penalties of equal duration to each team so penalized and the penalties of the players for which substitutions have been made shall not be taken into account for the purpose of the delayed penalty rule (Rule **27**). This rule only applies when at least one team is already serving a time penalty in the penalty box that causes them to be short-handed.

When one minor penalty is assessed to one player of each team at the same stoppage in play, these penalties will be served without substitution provided there are no other penalties in effect and visible on the penalty clocks. Both teams will therefore play four skaters against four skaters for the duration of the minor penalties.

Should one or both of these players also incur a misconduct penalty in addition to their one minor penalty, this rule shall apply and the teams would still play four skaters against four skaters (the player incurring the misconduct penalty would have to serve the entire 12 minutes – minor plus misconduct – and his team would have to place an additional player on the penalty bench to serve the minor penalty and be able to return to the ice when the minor penalty expires).

When multiple penalties are assessed to both teams, equal numbers of minor and major penalties shall be eliminated using the coincident penalty rule and any differential in time penalties shall be served in the normal manner and displayed on the penalty time clock accordingly (see **19.5**). If there is no differential in time penalties, all players will serve their allotted penalty time, but will not be released until the first stoppage of play following the expiration of their respective penalties.

For coincidental penalties that carry over into, or are assessed during regular-season overtime, refer to **84.3**, to Reference Tables – Table 19 – Penalties In Effect Prior to the Start of Overtime – Regular-



season on page 157, and to Reference Tables – Table 20 – Penalties Assessed in Overtime – Regular-season on page 158.

- 19.2 **Coincidental Major Penalties** - When coincident major penalties or coincident penalties of equal duration, including a major and/or a match penalty, are imposed against players of both teams, the penalized players shall all take their places on the penalty benches and such penalized players shall not leave the penalty benches until the first stoppage of play following the expiry of their respective penalties. Immediate substitutions shall be made for an equal number of major penalties, or coincident penalties of equal duration including a major penalty to each team so penalized, and the penalties of the players for which substitutions have been made shall not be taken into account for the purpose of the delayed penalty rule, (Rule 27). In such situations, if one or both players have received a game misconduct in addition to their major penalties, no substitutes are required to take their places on the penalty benches.
- 19.3 **Coincidental Match Penalties** - When coincident match penalties or coincident penalties of equal duration, including a major and/or a match penalty, are imposed against players of both teams, the players with the match penalties shall be immediately removed from the game and their substitutes shall take their places on the penalty benches. These penalized players shall not leave the penalty benches until the first stoppage of play following the expiry of their respective penalties. Immediate substitutions shall be made for an equal number of major and/or match penalties, or coincident penalties of equal duration including a major or match penalty to each team so penalized, and the penalties of the players for which substitutions have been made shall not be taken into account for the purpose of the delayed penalty rule, (Rule 27).
- 19.4 **Last Five Minutes and Overtime** - During the last five (5) minutes of regulation time, or at any time in overtime, when a minor penalty (or double-minor penalty) is assessed to one player of Team A, and a major (or match) penalty is assessed to one player of Team B at the same stoppage of play, the three-minute (or one-minute) differential shall be served immediately as a major penalty. This is also applicable when coincidental penalties are negated, leaving the aforementioned examples. In such instances, the team of the player receiving the major penalty must place the replacement player in the penalty bench prior to expiration of the penalty. In the case of a match penalty, the team must place the replacement player in the penalty bench immediately. The differential will be recorded on the penalty clock as a three (3) minute or a one (1) minute penalty (as applicable), and served in the same manner as a major penalty. This rule shall be applied regardless as to the on-ice strength of the two teams at the time the above outlined penalties are assessed.
- 19.5 **Applying the Coincidental Penalty Rule** – When multiple penalties are assessed to both teams at the same stoppage of play, the following rules are to be utilized by the Referees to determine the on-ice strength for both teams:



- (i) *Cancel as many major and/or match penalties as possible*
- (ii) *Cancel as many minor, bench minor and or double-minor penalties as possible*

Refer to Reference Tables - Table 17 – Coincidental Penalties on page 148.

## **Rule 20 – Major Penalties**

**20.1 Major Penalty** - For the first major penalty in any one game, the offender, except the goalkeeper, shall be ruled off the ice for five (5) minutes during which time no substitute shall be permitted.

When one player receives a major penalty and a minor penalty at the same time, the major penalty shall be served first by the penalized player (or substitute for the goalkeeper), except under Rule **19.2** where coincidental major penalties are in effect, in which case the minor penalty will be recorded and served first.

**20.2 Short-handed** – Although a major penalty does cause a team to be short-handed, the penalized player serving the major penalty does not leave the penalty bench when the opposing team scores. The player must wait for the entire major penalty to expire before he is permitted to exit the penalty bench.

**20.3 Substitution** – When a player has been assessed a major penalty and has been removed from the game or is injured, the offending team does not have to place a substitute player on the penalty bench immediately, but must do so at a stoppage of play prior to the expiration of the major penalty. He may then legally exit the penalty bench when the major penalty has expired.

Failure to place a player on the penalty bench prior to the expiration of the major penalty will result in that team having to continue playing one player short (but not officially considered short-handed) until the next stoppage of play. Any replacement player who enters the game other than from the penalty bench shall constitute an illegal substitution under Rule **68** – Illegal Substitution calling for a bench minor penalty.

Furthermore, if the team fails to place a player on the penalty bench to return to the ice at the end of the major penalty, they continued to play short-handed but are not permitted to ice the puck as they are no longer short-handed by reason of a penalty.

**20.4 Automatic Game Misconduct** – An automatic game misconduct shall be applied to any player who has been assessed a third major penalty in the same game.

An automatic game misconduct shall also be applicable whenever a player is assessed a major penalty for any of the infractions listed in the Reference Tables – Table 6 – Summary of Major Penalties that Result in an Automatic Game Misconduct (page 133). See specific rule numbers for complete descriptions.





When a player has been assessed a major penalty for any of the infractions listed in the Reference Tables – Table 7 – Summary of Major Penalties that Result in an Automatic Game Misconduct When There is an Injury to the Face or Head (page 134) and his opponent has suffered an injury to the face or head, a game misconduct must also be assessed. See specific rule numbers for complete descriptions.

When a major and automatic game misconduct are assessed, the player shall be ruled off the ice for the balance of the game, but a substitute shall be permitted to replace the player so suspended after five (5) minutes have elapsed.

- 20.5 **Fines** - An automatic fine of one hundred dollars (\$100) shall also be added when a major penalty is imposed for any foul causing injury to the face or head of an opponent by means of a stick.

When a player is assessed a major penalty plus a game misconduct as outlined in **20.4** above, he also receives an automatic fine of two hundred dollars (\$200).

- 20.6 **Infractions** – Refer to the Reference Tables – Table 5 – Summary of Major Penalties (page 133) for a list of the infractions that can result in a major penalty being assessed (see specific rule numbers for complete descriptions).

## **Rule 21 – Match Penalties**

- 21.1 **Match Penalty** - A match penalty involves the suspension of a player for the balance of the game and the offender shall be ordered to the dressing room immediately.

A match penalty shall be imposed on any player who deliberately attempts to injure or who deliberately injures an opponent in any manner.

- 21.2 **Short-handed** - A substitute player is permitted to replace the penalized player after five (5) minutes playing time has elapsed.

The match penalty, plus any additional penalties, shall be served by a player to be designated by the Manager or Coach of the offending team through the playing Captain, such player to take his place in the penalty box immediately.

For all match penalties, regardless of when imposed, or prescribed additional penalties, a total of ten minutes shall be charged in the records against the offending player.

In addition to the match penalty, the player shall be automatically suspended from further competition until the Commissioner has ruled on the issue. See also Rule **29** – Supplementary Discipline.

- 21.3 **Reports** - The Referee is required to report all match penalties and the surrounding circumstances to the Commissioner of the League immediately following the game in which they occur.



21.4 **Infractions** – Refer to the Reference Tables – Table 8 – Summary of Match Penalties (page 134) for a list of the infractions that can result in a match penalty being assessed (see specific rule numbers for complete descriptions).

## **Rule 22 – Misconduct Penalties**

22.1 **Misconduct Penalty** - In the event of misconduct penalties to any players except the goalkeeper, the players shall be ruled off the ice for a period of ten (10) minutes each. A substitute player is permitted to immediately replace a player serving a misconduct penalty. A player whose misconduct penalty has expired shall remain in the penalty box until the next stoppage of play.

22.2 **Misconduct Penalty – Goalkeeper** - Should a goalkeeper on the ice incur a misconduct penalty, this penalty shall be served by another member of his team who was on the ice when the offense was committed. This player is to be designated by the Manager or Coach of the offending team through the Captain.

22.3 **Short-handed** – A player receiving a misconduct penalty does not cause his team to play short-handed unless he also receives a minor, major or match penalty in addition to the misconduct penalty.

When a player receives a minor penalty and a misconduct penalty at the same time, the penalized team shall immediately put a substitute player on the penalty bench and he shall serve the minor penalty without change. Should the opposing team score during the time the minor penalty is being served, the minor penalty shall terminate (unless **15.4** is applicable) and the misconduct to the originally penalized player shall commence immediately.

When a player receives a major penalty and a misconduct penalty at the same time, the penalized team shall place a substitute player on the penalty bench before the major penalty expires and no replacement for the penalized player shall be permitted to enter the game except from the penalty bench.

22.4 **Reporting** – All misconduct penalties assessed for abuse of officials must be reported in detail to the League office.

22.5 **Fines** - A misconduct penalty imposed on any player at any time shall be accompanied with an automatic fine of one hundred dollars (\$100).

22.6 **Infractions** – Refer to the Reference Tables – Table 9 – Summary of Misconduct Penalties (page 135) for a list of the infractions that can result in a misconduct penalty being assessed (see specific rule numbers for complete descriptions).



## **Rule 23 – Game Misconduct Penalties**

- 23.1 **Game Misconduct Penalty** - A game misconduct penalty involves the suspension of a player for the balance of the game but a substitute is permitted to replace immediately the player so removed.
- 23.2 **Fines and Suspensions** - A player incurring a game misconduct penalty shall incur an automatic fine of two hundred dollars (\$200) and the case shall be reported to the Commissioner who shall have full power to impose such further penalties by way of suspension or fine on the penalized player or any other player involved in the altercation.

Any game misconduct penalty for which a player has been assessed an automatic suspension or supplementary discipline in the form of game suspension(s) by the Commissioner shall not be taken into account when calculating the total number of offenses under this subsection.

The automatic suspensions incurred under this subsection in respect to League games shall have no effect with respect to violations during Playoff games.

Any request by a Club to have a game misconduct reviewed and rescinded by the League must submit their request in writing to the League's Hockey Operations Department within 48 hours of the conclusion of the game in which the game misconduct was assessed. Failure to submit the written request within this time frame will automatically result in the game misconduct being upheld and no further review of the incident will be considered or entertained. This does not apply to infractions addressed under Rule 29 – Supplementary Discipline.

- 23.3 **Fines and Suspensions – General Category** - In regular League games, any player who incurs a total of three (3) game misconduct penalties in the "General Category" and exclusive of other designated categories, shall be suspended for the next League game of his team. For each subsequent game misconduct penalty, the automatic suspension shall be increased by one game. For each suspension of a player or goalkeeper, his Club shall be fined one thousand dollars (\$1,000).

In Playoff games, any player who incurs a total of two game misconduct penalties in the "General Category" shall be suspended automatically for the next Playoff game of his team. For each subsequent game misconduct penalty during the Playoffs, the automatic suspension shall be increased by one game. For each suspension of a player during Playoffs, his club shall be fined one thousand dollars (\$1,000).

For a list of infractions involving game misconducts that are included in the "General Category", please refer to the Reference Tables – Table 10 – Summary of Game Misconduct Fouls Included in the "General Category" (page 135). See specific rule numbers for complete descriptions.



**23.4 Fines and Suspensions – Abuse of Officials Category** - In regular League or Playoff games, any player who incurs a total of two (2) game misconduct penalties for abuse of officials related infractions penalized under Rule **40** - Abuse of Officials, shall be suspended automatically for the next League or Playoff game of his team. For each subsequent game misconduct penalty, the automatic suspension shall be increased by one game.

**23.5 Fines and Suspensions – Stick Infractions, Boarding and Checking from Behind Category** - In regular League games, any player who incurs a total of two (2) game misconduct penalties for stick-related infractions, Boarding – Rule **42**, or Checking from Behind – Rule **44**, shall be suspended automatically for the next League game of his team. For each subsequent game misconduct penalty, the automatic suspension shall be increased by one game.

In Playoff games any player who incurs a total of two (2) game misconduct penalties for stick-related infractions, Boarding – Rule **42**, or Checking from Behind – Rule **44**, shall be suspended automatically for the next Playoff game of his team. For each subsequent game misconduct penalty in this category during the Playoffs the automatic suspension shall be increased by one game.

Prior to the commencement of each Stanley Cup Finals, a player will have his current stick-related, boarding and checking from behind game misconducts removed from his current playoff record. They will remain part of his historical record.

When a player has played in 41 consecutive regular League games without being assessed a stick-related major and a game misconduct penalty according to Rule **20** – Major Penalties or Rule **22** – Misconduct Penalties, he will have the previous game misconduct penalties removed from his current record. They will remain part of his historical record.

For a list of stick-related infractions, refer to the Reference Tables – Table 11 – Summary of Game Misconduct Fouls Included in the “Stick-Related Category” (page 136). See specific rule numbers for complete descriptions.

When a player has played in 41 consecutive regular League games without being assessed a boarding and/or a checking from behind major and a game misconduct according to Rules **42** and **44**, he will have the previous game misconduct penalties removed from his current record. They will remain part of his historical record.

A player’s total games played will cover a two-year time period from the date of the first game misconduct penalty for each category of foul.

**23.6 Automatic Game Misconduct** – See **20.4**.

**23.7 Other Infractions That Could Result in a Game Misconduct** – Refer to the Reference Tables – Table 12 – Summary of Game Misconduct Penalties (page 137) for a list of the infractions that can



result in a game misconduct penalty being assessed (see specific rule numbers for complete descriptions).

In addition, the following list of infractions can also result in a game misconduct penalty being assessed:

- (i) *interfering with or striking a spectator.*
- (ii) *racial taunts or slurs*
- (iii) *spitting on or at an opponent or spectator*

Any player or non-playing Club personnel who physically interferes with the spectators, becomes involved in an altercation with a spectator, or throws any object at a spectator, shall automatically incur a game misconduct penalty and the Referee shall report all such infractions to the Commissioner who shall have full power to impose such further penalty as he shall deem appropriate.

### **Rule 24 – (Not in use)**

NOTE: Gross misconduct penalties have been re-classified as game misconduct penalties (see 23.7). The term “gross misconduct penalty” is no longer in use.

### **Rule 25 – Penalty Shot**

25.1 **Penalty Shot** – A penalty shot is designed to restore a scoring opportunity which was lost as a result of a foul being committed by the offending team, based on the parameters set out in these rules.

25.2 **Procedure** - The Referee shall ask to have announced over the public address system the name of the player designated by him or selected by the team entitled to take the shot (as appropriate). He shall then place the puck on the center face-off spot and the player taking the shot will, on the instruction of the Referee (by blowing his whistle), play the puck from there and shall attempt to score on the goalkeeper. The puck must be kept in motion towards the opponent’s goal line and once it is shot, the play shall be considered complete. No goal can be scored on a rebound of any kind (an exception being the puck off the goal post or crossbar, then the goalkeeper and then directly into the goal), and any time the puck crosses the goal line or comes to a complete stop, the shot shall be considered complete.

The lacrosse-like move whereby the puck is picked up on the blade of the stick and “whipped” into the net shall be permitted provided the puck is not raised above the height of the shoulders at any time and when released, is not carried higher than the crossbar. See also **80.1**.

The spin-o-rama type move where the player completes a 360° turn as he approaches the goal, shall be permitted as this involves continuous motion.

Only a player designated as a goalkeeper or alternate goalkeeper



may defend against the penalty shot.

The goalkeeper must remain in his crease until the player taking the penalty shot has touched the puck.

If at the time a penalty shot is awarded, the goalkeeper of the penalized team has been removed from the ice to substitute another player, the goalkeeper shall be permitted to return to the ice before the penalty shot is taken.

The team against whom the penalty shot has been assessed may replace their goalkeeper to defend against the penalty shot, however, the substitute goalkeeper is required to remain in the game until the next stoppage of play.

While the penalty shot is being taken, players of both sides shall withdraw to the sides of the rink and in front of their own player's bench.

- 25.3 **Designated Player** – In cases where a penalty shot has been awarded to a player specifically fouled, that player shall be designated by the Referee to take the penalty shot.

In all other cases where a penalty shot has been awarded, the penalty shot shall be taken by a player selected by the Captain of the non-offending team from the players on the ice at the time when the foul was committed. Such selection shall be reported to the Referee and cannot be changed.

If by reason of injury, the player designated by the Referee to take the penalty shot is unable to do so within a reasonable time, the shot may be taken by a player selected by the Captain of the non-offending team from the players on the ice when the foul was committed. Such selection shall be reported to the Referee and cannot be changed.

Should the player in respect to whom a penalty shot has been awarded himself commit a foul in connection with the same play or circumstances, either before or after the penalty shot has been awarded, be designated to take the shot, he shall first be permitted to do so before being sent to the penalty bench to serve the penalty except when such penalty is for a game misconduct or match penalty in which case the penalty shot shall be taken by a player selected by the Captain of the non-offending team from the players on the ice at the time when the foul was committed.

- 25.4 **Violations During the Shot** – Should the goalkeeper leave his crease prior to the player taking the penalty shot has touched the puck, and in the event of violation of this rule or any foul committed by a goalkeeper, the Referee shall allow the shot to be taken and if the shot fails, he shall permit the penalty shot to be taken over again. When an infraction worthy of a minor penalty is committed by the goalkeeper during the penalty shot that causes the shot to fail, no penalty is to be assessed but the Referee shall permit the shot to be taken over again. Should a goalkeeper commit a second violation during the penalty shot and the shot fails, he shall be assessed a



misconduct penalty and the Referee shall permit the penalty shot to be taken over again. A third such violation shall result in the goalkeeper being assessed a game misconduct penalty.

When a major or match penalty is committed by the goalkeeper that causes the shot to fail, the Referee shall permit the shot to be taken over again and the appropriate penalties shall be assessed to the goalkeeper.

The goalkeeper may attempt to stop the shot in any manner except by throwing his stick or any object, or by deliberately dislodging the goal, in which case a goal shall be awarded.

If, while the penalty shot is being taken, any player, Coach or non-playing Club personnel of the opposing team shall have by some action interfered with or distracted the player taking the shot and, because of such action, the shot should have failed, a second attempt shall be permitted and the Referee shall impose a bench minor penalty to the offending team, and if a player on the bench is responsible, a misconduct penalty on the player so interfering or distracting shall be assessed. When a Coach or non-playing Club personnel is guilty of such an act, he shall be automatically suspended from the game, ordered to the dressing room and the matter will be reported to the Commissioner for possible further disciplinary action.

If, while the penalty shot is being taken, any player, goalkeeper, Coach or non-playing Club personnel of the team taking the shot shall have by some action interfered with or distracted the goalkeeper defending the shot and, because of such action, the shot was successful, the Referee shall rule no goal and shall impose a bench minor penalty to the offending team, and if a player or goalkeeper on the bench is responsible, a misconduct penalty on the player or goalkeeper so interfering or distracting shall be assessed.

If, while the penalty shot is being taken, a spectator throws any object onto the ice or, in the judgment of the Referee, interferes with the player taking the shot or the goalkeeper defending the shot, he shall permit the shot to be taken again.

If, after a player's stick has been ruled illegal, he attempts to take a penalty shot with a second stick that is also ruled illegal prior to taking the penalty shot, the opportunity to take the penalty shot shall be disallowed. The player shall be assessed one minor penalty for the first illegal stick.

- 25.5 **Face-Off Location** - If a goal is scored from a penalty shot, the puck shall be faced-off at center ice. If a goal is not scored, the puck shall be faced-off at either of the end face-off spots in the zone in which the penalty shot was tried.
- 25.6 **Results** - Should a goal be scored from a penalty shot, a further penalty to the offending player or goalkeeper shall not be applied unless the offense for which the penalty shot was awarded was such as to incur a major, match or misconduct penalty, in which case the



penalty prescribed for the particular offense shall be imposed.

If the offense for which the penalty shot was awarded was such as to normally incur a minor penalty, then regardless of whether the penalty shot results in a goal or not, no further minor penalty shall be served.

If the offense for which the penalty shot was awarded was such as to incur a double-minor penalty, or where the offending team is assessed an additional minor penalty on the same play in which a penalty shot was awarded, the first minor penalty is not assessed since the penalty shot was awarded to restore the lost scoring opportunity. The second minor penalty would be assessed and served regardless of whether the penalty shot results in a goal. This will be announced as a double-minor penalty for the appropriate foul and the player will serve two (2) minutes only.

No penalty shall expire when a goal is scored against a team on a penalty shot.

Should two penalty shots be awarded to the same team at the same stoppage of play (two separate fouls), only one goal can be scored or awarded at a single stoppage of play. Should the first penalty shot result in a goal, the second shot would not be taken but the appropriate penalty would be assessed and served for the infraction committed.

- 25.7 **Timing** - If the foul upon which the penalty shot is based occurs during actual playing time, the penalty shot shall be awarded and taken immediately in the usual manner notwithstanding any delay occasioned by a slow whistle by the Referee to allow play to continue until the attacking side has lost possession of the puck to the defending side, which delay results in the expiry of the regular playing time in any period.

The time required for the taking of a penalty shot shall not be included in the regular playing time or overtime.

- 25.8 **Infractions** – Refer to the Reference Tables – Table 13 – Summary of Penalty Shots (page 137) for a list of the infractions that shall result in a penalty shot being awarded (see specific rule numbers for complete descriptions).

There are four (4) specific conditions that must be met in order for the Referee to award a penalty shot for a player being fouled from behind. They are:

- (i) *The infraction must have taken place in the neutral zone or attacking zone, (i.e. over the puck carrier's own blue line);*
- (ii) *The infraction must have been committed from behind;*
- (iii) *The player in possession and control (or, in the judgment of the Referee, clearly would have obtained possession and control of the puck) must have been denied a reasonable chance to score (the fact that he got a shot off does not automatically eliminate this play from the penalty shot consideration criteria. If the foul was from behind and*





*he was denied a “more” reasonable scoring opportunity due to the foul, then the penalty shot should be awarded);*

- (iv) *The player in possession and control (or, in the judgment of the Referee, clearly would have obtained possession and control of the puck) must have had no opposing player between himself and the goalkeeper.*

## **Rule 26 – Awarded Goals**

- 26.1 **Awarded Goal** – A goal will be awarded to the attacking team when the opposing team has taken their goalkeeper off the ice and an attacking player has possession and control of the puck in the neutral or attacking zone, without a defending player between himself and the opposing goal, and he is prevented from scoring as a result of an infraction committed by the defending team (see 26.3 Infractions – When Goalkeeper is Off the Ice, below).
- 26.2 **Infractions – When Goalkeeper is On the Ice** – A goal will be awarded when an attacking player, in the act of shooting the puck into the goal (between the normal position of the posts and completely across the goal line), is prevented from scoring as a result of a defending player or goalkeeper displacing the goal post, either deliberately or accidentally.
- 26.3 **Infractions – When Goalkeeper is Off the Ice** – Refer to the Reference Tables – Table 14 – Summary of Awarded Goals (When Goalkeeper has been Removed for an Extra Attacker) (page 138) for a list of the infractions that shall result in an awarded goal being awarded when the goalkeeper has been removed for an extra attacker (see specific rule numbers for complete descriptions).
- 26.4 **Infractions – During the Course of a Penalty Shot** - A goal will be awarded when a goalkeeper attempts to stop a penalty shot by throwing his stick or any other object at the player taking the shot or by deliberately dislodging the goal.

## **Rule 27 – Delayed Penalties**

- 27.1 **Delayed Penalty** - If a third player of any team shall be penalized while two players of the same team are serving penalties, the penalty time of the third player shall not commence until the penalty time of one of the two players already penalized has elapsed. Nevertheless, the third penalized player must at once proceed to the penalty bench. He may be substituted for on the ice so as to keep the on-ice strength at no less than three skaters for his team.
- 27.2 **Penalty Expiration** - When any team shall have three players serving penalties at the same time and because of the delayed penalty rule, a substitute for the third offender is on the ice, none of the three penalized players on the penalty bench may return to the ice until play has stopped. When play has been stopped, the player whose full penalty has expired may return to the ice.



During the play, the Penalty Timekeeper shall permit the return to the ice of the penalized players, in the order of expiry of their penalties, but only when the penalized team is entitled to have more than four players on the ice. Otherwise, these players must wait until the first stoppage of play after the expiration of their penalties in order to be released from the penalty bench.

When the penalties of two players of the same team will expire at the same time, the Captain of that team will designate to the Referee which of such players will return to the ice first and the Referee will instruct the Penalty Timekeeper accordingly (this is done to expedite the release of a player from the penalty bench when the opposing team scores on the power-play).

- 27.3 **Major and Minor Penalty** - When a major and a minor penalty are imposed at the same time on different players of the same team, the Penalty Timekeeper shall record the minor as being the first of such penalties.

## **Rule 28 – Goalkeeper’s Penalties**

- 28.1 **Minor Penalty to Goalkeeper** – A goalkeeper shall not be sent to the penalty bench for an offense which incurs a minor penalty, but instead, the minor penalty shall be served by another member of his team who was on the ice when the offense was committed. This player is to be designated by the Manager or Coach of the offending team through the playing Captain and such substitute shall not be changed.

A penalized player may not serve a goalkeeper’s penalty.

- 28.2 **Major Penalty to Goalkeeper** – A goalkeeper shall not be sent to the penalty bench for an offense which incurs a major penalty, but instead, the major penalty shall be served by another member of his team who was on the ice when the offense was committed. This player is to be designated by the Manager or Coach of the offending team through the playing Captain and such substitute shall not be changed.

Should a goalkeeper incur three major penalties in one game, he shall be ruled off the ice for the balance of the playing time and his place shall be taken by a member of his own Club, or by a regular substitute goalkeeper who is available. Such player will be allowed the goalkeeper’s equipment. (Major penalty plus game misconduct penalty and automatic fine of two hundred dollars (\$200).)

- 28.3 **Misconduct Penalty to Goalkeeper** – Should a goalkeeper on the ice incur a misconduct penalty, this penalty shall be served by another member of his team who was on the ice when the offense was committed. This player is to be designated by the Manager or Coach of the offending team through the Captain and, in addition, the goalkeeper shall be fined one hundred dollars (\$100).



**28.4 Game Misconduct Penalty to Goalkeeper** – Should a goalkeeper incur a game misconduct penalty, his place will then be taken by a member of his own Club, or by a regular substitute goalkeeper who is available, and such player will be allowed the goalkeeper's full equipment. In addition, the goalkeeper shall be fined two hundred dollars (\$200).

**28.5 Match Penalty to Goalkeeper** – Should a goalkeeper incur a match penalty, his place will then be taken by a member of his own Club, or by a substitute goalkeeper who is available, and such player will be allowed the goalkeeper's full equipment.

The match penalty, and any additional penalties assessed to the goalkeeper, shall be served immediately by a member of the team on the ice when the offenses were committed. This player shall be designated by the Manager or Coach of the offending team through the Captain. However, when the match penalty is coincidental with a match or major penalty to the opposing team, no player is required to proceed to the penalty bench to serve the goalkeeper's match penalty.

**28.6 Leaving Goal Crease** – A minor penalty shall be imposed on a goalkeeper who leaves the immediate vicinity of his crease during an altercation. In addition, he shall be subject to a fine of two hundred dollars (\$200) and this incident shall be reported to the Commissioner for such further disciplinary action as may be required. However, should the altercation occur in or near the goalkeeper's crease, the Referee should direct the goalkeeper to a neutral location and not assess a penalty for leaving the immediate vicinity of the goal crease. Equally, if the goalkeeper is legitimately outside the immediate vicinity of the goal crease for the purpose of proceeding to the players' bench to be substituted for an extra attacker, and he subsequently becomes involved in an altercation, the minor penalty for leaving the crease would not be assessed.

In addition, during stoppages of play in the game, he must not proceed to his players' bench for the purpose of receiving a replacement stick or equipment or repairs thereto, or due to an injury, or to receive instructions, without first obtaining permission to do so from the Referee. Otherwise, he must be replaced by the substitute goalkeeper immediately (without any delay) or be assessed a bench minor penalty for delay of game.

**28.7 Participating in the Play Over the Center Red Line** - If a goalkeeper participates in the play in any manner (intentionally plays the puck or checks an opponent) when he is beyond the center red line, a minor penalty shall be imposed upon him. The position of the puck is the determining factor for the application of this rule.

**28.8 Restricted Area** – A goalkeeper shall not play the puck outside of the designated area behind the net. This area shall be defined by lines that begin six feet (6') from either goal post and extend diagonally to points twenty-eight feet (28') apart at the end boards. Should the goalkeeper play the puck outside of the designated area behind the goal line, a minor penalty for delay of game shall be imposed. The



determining factor shall be the position of the puck. The minor penalty will not be assessed when a goalkeeper plays the puck while maintaining skate contact with his goal crease.

- 28.9 **Infractions – Unique to Goalkeepers** – Refer to the Reference Tables – Table 15 – Summary of Goalkeeper Penalties (page 138) for a list of the infractions that shall result in a penalty to the goalkeeper (see specific rule numbers for complete descriptions).

## Rule 29 – Supplementary Discipline

- 29.1 **Supplementary Discipline** - In addition to the automatic fines and suspensions imposed under these rules, the Commissioner may, at his discretion, investigate any incident that occurs in connection with any Pre-season, Exhibition, League or Playoff game and may assess additional fines and/or suspensions for any offense committed during the course of a game or any aftermath thereof by a player, goalkeeper, Trainer, Manager, Coach or non-playing Club personnel or Club executive, whether or not such offense has been penalized by the Referee.

If an investigation is requested by a Club or by the League on its own initiative, it must be initiated within twenty-four (24) hours following the completion of the game in which the incident occurred.

- 29.2 **Pre-Season and Exhibition Games** - Whenever suspensions are imposed as a result of infractions occurring during pre-season and exhibition games, the Commissioner shall exercise his discretion in scheduling the suspensions to ensure that no team shall be short more players in any regular League game than it would have been had the infractions occurred in regular League games.

## Rule 30 – Signals

30.1 Boarding

Striking the clenched fist of one hand into the open palm of the opposite hand in front of the chest.



30.2 Butt-ending









Moving the forearm, fist closed, under the forearm of the other hand held palm down.





## SECTION 4 – TYPES OF PENALTIES



- |       |                      |   |   |
|-------|----------------------|---|---|
| 30.3  | Charging             | Rotating clenched fists around one another in front of the chest.   |    |
| 30.4  | Checking from behind | A forward motion of both arms, with the palms of the hands open and facing away from the body, fully extended from the chest at shoulder level. |    |
| 30.5  | Clipping             | Striking leg with either hand behind the knee, keeping both skates on the ice.  |    |
| 30.6  | Cross-checking       | A forward and backward motion of the arms with both fists clenched, extending from the chest for a distance of about one foot.                  |    |
| 30.7  | Delayed off-side     | Non-whistle arm fully extended above the head. To nullify a delayed off-side, the Linesman shall drop the arm to the side.                      |  |
| 30.8  | Delayed penalty      | Extending the non-whistle arm fully above the head.   |  |
| 30.9  | Delaying the game    | The non-whistle hand, palm open, is placed across the chest and then fully extended directly in front of the body.                              |  |
| 30.10 | Elbowing             | Tapping either elbow with the opposite hand.  |  |



## SECTION 4 – TYPES OF PENALTIES



- 30.11 Goal scored A single point directed at the goal in which the puck legally entered.



- 30.12 Hand pass With the palm open and facing forward, a pushing motion towards the front of the body once or twice to indicate the puck was moved ahead with the hand.



- 30.13 Head-butting No signal in the National Hockey League.

NO SIGNAL

- 30.14 High-sticking Holding both fists clenched, one slightly above the other (as if holding a stick) at the height of the forehead.



- 30.15 Holding Clasping either wrist with the other hand in front of the chest.



- 30.16 Holding the stick Two stage signal involving the holding signal (30.15) followed by a signal indicating you are holding onto a stick with two hands in a normal manner.

- 30.17 Hooking A tugging motion with both arms as if pulling something from in front toward the stomach.



- 30.18 Icing (a) The back Linesman signals a possible icing by fully extending either arm over his head. The arm should remain raised until the front Linesman either blows the whistle to indicate an icing or until the icing is washed





## SECTION 4 – TYPES OF PENALTIES



out

Icing (b) Once the icing has been completed, the back Linesman will then point to the appropriate face-off spot and skate to it, turning backwards somewhere near the blue line and crossing his arms across his chest to indicate icing.



30.19 Interference Crossing arms stationary in front of the chest in an "X" formation.



30.20 Kicking No signal in the National Hockey League.

NO SIGNAL

30.21 Kneeing Slapping either knee with the palm of the hand, while keeping both skates on the ice.



30.22 Match penalty No signal in the National Hockey League.

NO SIGNAL

30.23 Misconduct Both hands on hips.



30.24 Penalty shot Non-whistle arm fully extended pointing to the center ice face-off spot.









30.25 Roughing Fist clenched and arm extended out to the side of the body.





## SECTION 4 – TYPES OF PENALTIES



30.26	Slashing	A chopping motion with the edge of one hand across the opposite forearm.	
30.27	Spearing	Jabbing motion with both hands thrust out immediately in front of the body and then hands dropped to the side of the body (essentially the opposite to the hooking signal – away from the body rather than towards the body).	
30.28	Throwing equipment	No signal in the National Hockey League.	NO SIGNAL
30.29	Time-out	Using both hands to form a “T” in front of the chest.	
30.30	Too many men on the ice	No signal in the National Hockey League.	NO SIGNAL
30.31	Tripping	Striking leg with either hand below the knee, keeping both skates on the ice.	
30.32	Unsportsmanlike conduct	Using both hands to form a “T” in front of the chest (same as time-out).	
30.33	Wash out	A sweeping sideways motion of both arms across the front of the body at shoulder level with palms down. This signal is used by Referees to signal no goal; by the Linesmen to signal	





## SECTION 4 – TYPES OF PENALTIES



no icing and no off-side; and  
by all Officials to wash out a  
hand pass or a high-sticking  
the puck violation.



## SECTION 5 - OFFICIALS

### Rule 31 – Appointment of Officials

- 31.1 **Appointment of Officials by Commissioner** - The Commissioner shall appoint the Referees, the Linesmen, Video Goal Judge and all Off-ice Officials for each game.

The Commissioner shall forward to all Clubs a list of Referees, Linesmen, and Off-ice Officials, all of whom must be treated with proper respect at all times during the season by all players and officials of Clubs.

### Rule 32 – Referees

- 32.1 **Attire and Equipment** - All Referees shall be dressed in black trousers, official sweaters and a League-approved black helmet.

They shall be equipped with approved whistles, tape measure and an official stick-measuring gauge.

- 32.2 **Disputes** - The Referees shall have general supervision of the game and shall have full control of all game officials and players during the game, including stoppages; and in case of any dispute, their decision shall be final.

As there is a human factor involved in blowing the whistle to stop play, the Referee may deem the play to be stopped slightly prior to the whistle actually being blown. The fact that the puck may come loose or cross the goal line prior to the sound of the whistle has no bearing if the Referee has ruled that the play had been stopped prior to this happening.

In the event of any dispute regarding time or the expiration of penalties, the matter shall be referred to the Referee for adjustment and his decision shall be final. He may use the Video Goal Judge to assist in rendering the final decision. See Rule 39 – Video Goal Judge.

- 32.3 **Face-offs** – One of the Referees shall face-off the puck to start each period and following the scoring of a goal. Linesmen are responsible for all other face-offs.
- 32.4 **General Duties** - It shall be the duty of the Referees to impose such penalties as are prescribed by the rules for infractions thereof and they shall give the final decision in matters of disputed goals. The Referees may consult with the Linesmen, Goal Judge or Video Goal Judge before making their decision.

The Referees shall not halt the game for any infractions of the rules concerning Rule 83 - Off-side, or any violation of Rule 81 - Icing. Determining infractions of these rules is the duty of the Linesmen unless, by virtue of some accident, the Linesman is prevented from doing so in which case the duties of the Linesman shall be assumed



by a Referee until play is stopped.

- 32.5 **Goals** - The Referees shall have announced over the public address system information regarding the legality of an apparent goal. The Official Scorer, with the assistance of the Video Goal Judge, will confirm the goal scorer and any players deserving of an assist. See also Rule 78 – Goals.

The Referees shall have announced over the public address system the reason for not allowing a goal every time the goal signal light is turned on in the course of play. This shall be done at the first stoppage of play regardless of any standard signal given by the Referees when the goal signal light was put on in error.

The Referees shall report to the Official Scorer the name or number of the goal scorer but he shall not give any information or advice with respect to the awarding of assists.

The name of the scorer and any player entitled to an assist will be announced over the public address system. In the event that the Referee disallows a goal for any violation of the rules, he shall report the reason for the disallowance to the Official Scorer who shall have announced the Referee's decision correctly over the public address system.

- 32.6 **Off-ice Officials** - The Referees shall, before starting the game, see that the appointed off-ice officials, including the Game Timekeeper and the Goal Judges are in their respective places and ensure that the timing and signaling equipment are in order.
- 32.7 **Penalties** - The infraction of the rules for which each penalty has been imposed will be announced correctly, as reported by the Referee, over the public address system. Where players of both teams are penalized on the same play, the penalty to the visiting player will be announced first.

When a penalty is imposed by the Referee which calls for a mandatory or automatic fine, only the time portion of the penalty will be reported by the Referee to the Official Scorer and announced over the public address system, and the fine will be collected through the League office.

- 32.8 **Players' Uniforms** - It shall be the duty of the Referees to see to it that all players are properly dressed, and that the approved regulation equipment (including the approved on-ice branded exposure program) is in use at all times during the game.
- 32.9 **Reports** - The Referee shall report to the Commissioner promptly and in detail the circumstances surrounding the following:
- (i) *The assessment of misconduct penalties for abuse of officials;*
  - (ii) *The assessment of game misconduct penalties;*
  - (iii) *The assessment of match penalties;*
  - (iv) *The assessment of an instigator penalty;*



- (v) *Any time a goalkeeper leaves his crease during an altercation;*
- (vi) *Any time a stick or other object is thrown outside the playing area;*
- (vii) *Any time a player, goalkeeper or non-playing Club personnel are involved in an altercation with a spectator;*
- (viii) *Any unusual occurrence that takes place on or off the ice, before, during or after the game.*

**32.10 Start and End of Game and Periods** - The Referees shall order the teams on the ice at the appointed time for the beginning of a game and at the commencement of each period. If for any reason, there is more than a fifteen (15) minute delay in the commencement of the game or any undue delay in resuming play after the League approved intermission length between periods, the Referees shall state in their report to the Commissioner the cause of the delay and the Club or Clubs which were at fault.

The Referees shall remain on the ice at the conclusion of each period until all players have proceeded to their dressing rooms.

The Referees shall check club rosters and all players in uniform before signing the Official Report of Match form.

**32.11 Unable to Continue** - Should a Referee accidentally leave the ice or receive an injury which incapacitates him from discharging his duties while play is in progress, the game shall be automatically stopped. If the Referee is unable to continue, the game shall continue using the one Referee, two Linesmen system.

If, owing to illness or accident, one of the Referees is unable to continue to officiate, the remaining Referee shall perform the duties of the ill or injured Referee during the balance of the game. In the event that a member of the League's Hockey Operations or Officiating departments is in attendance at a game where a spare official is present, he shall have the authority to substitute the injured Referee with the spare official.

If, through misadventure or sickness, the Referees and Linesmen appointed are prevented from appearing, the League will make every attempt to find suitable replacement officials, otherwise, the Managers or Coaches of the two Clubs shall agree on Referee(s) and Linesman(men). If they are unable to agree, they shall appoint a player from each side who shall act as Referee and Linesman; the player of the home Club acting as Referee and the player of the visiting Club as Linesman.

If the regularly appointed officials appear during the progress of the game, they shall at once replace the temporary officials.

## **Rule 33 – Linesmen**

**33.1 Attire and Equipment** – All Linesmen shall be dressed in black trousers, official sweaters and a League-approved black helmet.



They shall be equipped with approved whistles, tape measure and an official stick-measuring gauge.

- 33.2 **Face-offs** - The Linesman shall face-off the puck at all times except at the start of each period and following the scoring of a goal.
- 33.3 **General Duties** – The Linesmen are generally responsible for calling violations of off-side (Rule **83**) and icing (Rule **81**). They may stop play for a variety of other situations as noted in sections **33.4** and **33.5** below.
- 33.4 **Reporting to Referee** - The Linesman shall give to the Referees his interpretation of any incident that may have taken place during the game.

The Linesman may stop play and report what he witnessed to the Referees when:

- |       |  |                |
|-------|--|----------------|
| (i)   | <i>There are too many men on the ice</i>                                       | <i>Rule 74</i> |
| (ii)  | <i>Articles are thrown on the ice from the players' bench or penalty bench</i> | <i>Rule 75</i> |
| (iii) | <i>When team personnel interfere with a game official</i>                      | <i>Rule 40</i> |
| (iv)  | <i>When a player who has lost or broken his stick receives one illegally</i>   | <i>Rule 10</i> |

The Linesman must report upon completion of play, any circumstances pertaining to:

- |        |  |                |
|--------|--|----------------|
| (i)    | <i>Major penalties</i>   | <i>Rule 20</i> |
| (ii)   | <i>Match penalties</i>   | <i>Rule 21</i> |
| (iii)  | <i>Misconduct penalties</i>  | <i>Rule 22</i> |
| (iv)   | <i>Game Misconduct penalties</i>   | <i>Rule 23</i> |
| (v)    | <i>Abuse of Officials</i>  | <i>Rule 40</i> |
| (vi)   | <i>Physical Abuse of Officials</i>   | <i>Rule 41</i> |
| (vii)  | <i>Unsportsmanlike Conduct</i>   | <i>Rule 75</i> |
| (viii) | <i>Double-minor penalty when it is apparent that an injury has resulted from a high-stick that has gone undetected by the Referees</i> | <i>Rule 60</i> |

Should a Linesman witness a foul (above) committed by an attacking player (undetected by the Referees) prior to the attacking team scoring a goal, the Linesman shall report what he witnessed to the Referees, the goal shall be disallowed and the appropriate penalty assessed.

- 33.5 **Stopping Play** - The Linesman shall stop play:

- |      |   |                |
|------|---|----------------|
| (i)  | <i>When premature substitution of the goalkeeper has occurred</i>                                 | <i>Rule 71</i> |
| (ii) | <i>When he deems that a player has sustained a serious injury and this has gone undetected by</i> | <i>Rule 8</i>  |



*either of the referees*

- |        |   |                |                |
|--------|---|----------------|----------------|
| (iii)  | <i>For encroachment into the face-off area</i>  | <i>Rule 76</i> |                |
| (iv)   | <i>When the puck has been directed with a hand to a teammate in any zone other than the defending zone and this has gone undetected by either of the Referees</i> | <i>Rule 79</i> |                |
| (v)    | <i>When the puck is struck by a stick above the normal height of the shoulders and this has gone undetected by either of the Referees</i>                         | <i>Rule 80</i> |                |
| (vi)   | <i>When either team ices the puck</i>   | <i>Rule 81</i> |                |
| (vii)  | <i>When there has been interference by/with spectators</i>  | <i>Rule 23</i> |                |
| (viii) | <i>For any infraction of the rules concerning off-side play at the blue line</i>  | <i>Rule 83</i> |                |
| (ix)   | <i>When the puck is out of bounds or unplayable</i>   | <i>Rule 85</i> |                |
| (x)    | <i>When a goal has been scored that has not been observed by the Referees.</i>  | <i>Rule 78</i> |                |
| (xi)   | <i>When the puck is interfered with by an ineligible player/person</i>  | <i>Rule 5</i>  | <i>Rule 78</i> |
|        |   | <i>Rule 74</i> | <i>Rule 84</i> |
| (xii)  | <i>The calling of a penalty shot under</i>  | <i>Rule 53</i> |                |

**33.6 Unable to Continue** - Should a Linesman appointed be unable to act at the last minute or through sickness or accident be unable to finish the game, the Referees shall have the power to appoint another in his stead, if they deem it necessary, or if required to do so by the Manager or Coach of either of the competing teams. If no replacement Linesman is available, the two Referees will assist the remaining Linesman with his duties while still retaining their ability to assess penalties when deemed appropriate.

## **Rule 34 – Official Scorer**

**34.1 General Duties** - Before the start of the game, the Official Scorer shall obtain from the Manager or Coach of both teams a list of all eligible players and the starting line-up of each team, which information shall be made known to the opposing Manager or Coach before the start of play.

The Official Scorer shall secure the names of the Captain and Alternate Captains from the Manager or Coach at the time the line-ups are collected and will indicate those nominated by placing the letter "C" or "A" opposite their names on the Official Report of Match form.

The Official Scorer shall keep a record of the goals scored, the scorers, and players to whom assists have been credited and shall indicate those players on the lists who have actually taken part in the game.



At the conclusion of the game, the Official Scorer shall complete and sign the Score Sheet form and forward same to the League office.

The Official Scorer shall prepare the Official Report of Match form for signature by the Referees and forward it to the League office together with the Score Sheet and the Penalty Record forms.

Under the Report of Match section, the Official Scorer must explain if the start of the game is delayed for any reason, any goalkeeper substitutions, time-outs, empty net goals, any delays in the playing of the game due to injury or television, etc.

- 34.2 Goals and Assists** - The Official Scorer shall award the points for goals and assists and his decision shall be final. The Official Scorer shall use the Video Goal Judge system to verify the proper awarding of goals and assists. The awards of points for goals and assists shall be announced twice over the public address system and all changes in such awards shall also be announced in the same manner.

No requests for changes in any award of points shall be considered unless they are made at or before the conclusion of actual play in the game by the Team Captain, or immediately following the game by a Team representative.

In the event that the Video Goal Judge reviews a play and a goal is awarded even though play went for any period of time, the Official Scorer awards the goal and any assists at the time the goal was scored. If he is unsure, he must check with the Video Goal Judge. The Game Timekeeper and the Penalty Timekeeper must also be informed in order to adjust the clock and the penalty clocks accordingly.

A goal is awarded to the last player on the scoring team to touch the puck prior to the puck entering the net. (A puck entering the net is considered to be between the posts, from in front of, and below the crossbar, and entirely across the goal line.)

An assist is awarded to the player or players (maximum two) who touches the puck prior to the goal scorer, provided no defender plays or possesses the puck in between.

Assists can be given to deserving players on a goal that has been awarded by the Referee, if the Official Scorer deems that assists would have been given on the eventual goal anyway.

- 34.3 Line-ups** - It is the policy of the National Hockey League that the Coach of the visiting club provide to the Official Scorer, a list of eligible players, his starting line-up and designated Captain and Alternates, within five (5) minutes of the completion of the warm-up (twenty (20) minutes prior to face-off).

This twenty (20) minutes gives the Official Scorer time to obtain the completed home team line-up, return it to the visiting Coach and provide a copy of both line-ups to the Referees.



The Official Scorer should have an off-ice crew member assist him in order to save time and complete these duties.

The Official Scorer must file a report to the Commissioner or his designate if either Coach fails to cooperate within these recommended guidelines. This report should be forwarded to the National Hockey League Toronto office.

- 34.4 **Location** - The Official Scorer should view the game from an elevated position, well away from the players' benches, with house telephone communication to the public address announcer. He should also have access to a television monitor along with a recording device with simultaneous play and record capabilities to aid in the awarding of points. He must have access to the Video Goal Judge.
- 34.5 **Penalties** - The Official Scorer must help the Penalty Timekeeper with the numbers of the players on the ice, in the event a goalkeeper is assessed a penalty or a player is ejected from a game. He must also keep an eye on the players' benches during an altercation and record the numbers of any players who leave their respective players' or penalty benches and in the order that they so leave.

## **Rule 35 – Game Timekeeper**

- 35.1 **General Duties** – The Game Timekeeper shall record the time of starting and finishing of each period in the game. During the game the Game Timekeeper will start the clock with the drop of the puck and stop the clock upon hearing the officials' whistle or the scoring of a goal.

The Game Timekeeper shall cause to be announced over the public address system at the nineteenth minute in each period that there is one minute remaining to be played in the period.

- 35.2 **Intermissions** - For the purpose of keeping the spectators informed as to the time remaining during intermissions, the Game Timekeeper will use the electronic clock to record the length of intermissions. The clock will start for the intermission immediately at the conclusion of the period.

Intermissions are seventeen minutes (17:00) in length, unless otherwise notified. If there are unusual delays for any reason, (e.g. altercation, building, ice, or ice resurfacing problems) it is important to use discretion in starting the clock.

- 35.3 **Overtime** - In the event of overtime in the regular season, the Game Timekeeper shall record a one (1) minute rest period on the clock. This time shall commence immediately following the end of the period. The rest period will be followed with a five (5) minute, sudden victory overtime period.

During overtime in the play-offs, each intermission will be completed in a normal manner.





- 35.4 **Signal Devices** - If the arena is not equipped with an automatic signaling device or, if such device fails to function, the Game Timekeeper shall signal the end of each period by blowing a whistle.
- 35.5 **Start of Periods** - The Game Timekeeper shall signal the Referees and the competing teams for the start of the game and each succeeding period and the Referees shall start the play promptly in accordance with Rule 77 – Game and Intermission Timing.
- To assist in ensuring the prompt return to the ice of the teams and the officials, the Game Timekeeper shall give preliminary warnings of five (5) minutes and two (2) minutes prior to the resumption of play in each period.
- 35.6 **Television** - The Game Timekeeper is required to synchronize his timing device with the television producer of the originating broadcast.
- 35.7 **Verification of Time** - Any loss of time on the game or penalty clocks due to a false face-off must be replaced as appropriate. The Video Goal Judge may be consulted to ensure the time is accurately replaced.

In the event of any dispute regarding time, the matter shall be referred to the Referees for adjudication and their decision shall be final. They may use the Video Goal Judge to assist in rendering their final decision. (See Rule 39 – Video Goal Judge.) The Game Timekeeper shall assist to verify game time using an additional timing device (League-approved stopwatch).

In the event that clock fails to operate when play resumes, the on-ice officials may elect to stop play provided there is no imminent scoring opportunity or wait until the next legitimate stoppage of play. In cooperation with the Game Timekeeper and the Video Goal Judge, the clock is to be re-set to the appropriate time.

In the event that a video replay shows a goal was scored prior to the play being stopped, the Video Goal Judge will inform the Game Timekeeper and Official Scorer of the time of goal and the amount of playing time left to be reset on the game clock.

## **Rule 36 – Penalty Timekeeper**

- 36.1 **General Duties** – The Penalty Timekeeper shall keep, on the Penalty Record form, a correct record of all penalties imposed by the Referees including the names of the players penalized, the penalties assessed, the duration of each penalty and the time at which each penalty was imposed.

The Penalty Timekeeper shall inform penalized players and the Penalty Box Attendants as to the correct expiration time of all penalties. In the event of a dispute regarding the time a player is permitted to return to the ice, the game clock is the determining time clock. For example, a player is assessed a minor penalty at the 12:00 mark. A stoppage of play occurs at the 10:00 mark, however, the



penalty time clock shows one second remaining in the penalty. Since the game clock is the determining time clock, the penalized player shall be permitted to return to the ice.

The infraction of the rules for which each penalty has been imposed will be announced twice over the public address system as reported by the Referee. Where players of both teams are penalized at the same time, the penalty to the visiting player will be announced first. In situations where multiple game misconducts have been assessed to any one player at the same stoppage of play, only one game misconduct should be announced.

Misconduct penalties and coincident major penalties should not be recorded on the timing device (penalty time clock) but such penalized players should be alerted and released at the first stoppage of play following the expiration of their penalties.

When a player is assessed a misconduct in addition to other penalties, the misconduct shall only commence after all other penalties have been served (or washed out by the scoring of a goal).

If a player leaves the penalty bench before the time has expired, the Penalty Timekeeper must note the time and notify the Referees at his first opportunity.

It is the responsibility of the Penalty Timekeeper to ensure that penalized players return to the penalty box before the puck is dropped for the start of a new period. In the event that a penalized player is not be in the penalty box, the Penalty Timekeeper should notify the Referees and prevent the game from resuming until the player is there.

- 36.2 **Equipment** - The Penalty Timekeeper shall have an official stick-measuring gauge and tape measure available for the Referees use during the game.
- 36.3 **Goalkeeper's Penalties** - In the event that a goalkeeper is penalized, the penalty shall be served by another member of his team who was on the ice when the offense was committed. Communication with the Official Scorer and/or Real Time Scorers is important at this time as they can inform the Penalty Timekeeper who was actually on the ice to ensure only the proper players can serve the time.
- 36.4 **Penalty Shot** - He shall report on the Penalty Record form each penalty shot awarded, the name of the player taking the shot and the result of the shot.
- 36.5 **Penalty Time Clock** - He shall be responsible for the correct posting of penalties on the scoreboard at all times and shall promptly call to the attention of the Referees any discrepancy between the time recorded on the clock and the official correct time and he shall be responsible for making any adjustments ordered by the Referees.

In the event that two players from one team and one player from the opposing team are penalized at the same time, the Penalty



Timekeeper shall request through the Referee or the offending team's Captain, which penalty they prefer to have on the timing device.

- 36.6 **Reports** – Prior to each game, the Penalty Timekeeper shall obtain copies of the Instigator, Aggressor & Game Misconduct List provided by the League, retain one copy and provide one to the Referees. Should a player be assessed a penalty that would result in an automatic suspension, this must be conveyed to the Referee at the time the penalty is assessed to ensure a Game Misconduct penalty is applied.

Upon the completion of each game, the Penalty Timekeeper shall complete and sign the Penalty Record form and forward same to the League office.

The Officiating Department shall be entitled to inspect, collect and forward to the League office the actual worksheets used by the Penalty Timekeeper in any game.

When a player is ejected from a game, the Penalty Timekeeper must complete a report of the incident (Off-Ice Officials Report of Game Misconduct/Match Penalties). When there are more than one of these incidents, it is imperative to provide the Referee with accurate information for each incident so that his report(s) to the League office is correct.

- 36.7 **Stick Measurements** - He shall also record on the Penalty Record form the details and the result of any stick measurement performed by the Referees during the game.
- 36.8 **Verification of Time** - In the event that a goal is awarded by video review even though play continued, the Penalty Timekeeper must adjust any existing penalties, according to the situation. The clock must revert back to the original time the goal was scored. If a penalty was in the process of being called, it will revert back to that time also.

### **Rule 37 – Goal Judge**

- 37.1 **General Duties** - He shall signal, normally by means of red light, his decision as to whether the puck passed between the goal posts and entirely over the goal line. His only decision is whether the puck actually entered the net, not how or when it went in. The light must be illuminated for a period of five (5) seconds each time the puck enters the net regardless of circumstances. It is up to the Referees and/or Video Goal Judge to decide if it is a goal.
- 37.2 **Communication** - The Goal Judge must be connected to the penalty bench by a form of communication (usually phone) in the event that the Referees finds it necessary to consult with him.
- 37.3 **Location** - There shall be one Goal Judge situated behind each goal (or in an area designated and approved by NHL Hockey Operations), in properly protected areas, if possible, so that there can be no interference with their activities. They shall not change goals during



the game.

## **Rule 38 – Real Time Scorers**

**38.1 General Duties** – The duty of the Real Time Scorers is to electronically record all official statistics for the game played.

This data shall be compiled and recorded in strict conformity with the instructions provided by the League.

**38.2 Real Time Scorers** – There shall be appointed for duty at every game played in the League the following Real Time Scorers:

- (i) *Stats Entry Scorer*
- (ii) *Stats Entry Scorer*
- (iii) *Time on ice Scorer – Home*
- (iv) *Time on ice Scorer – Visitor*
- (v) *Spotter*

Assigned by the League to oversee the Real Time Scorers and the data collected is a Scoring System Manager (SSM), an off-ice official who is required to work one of the five (5) positions noted above in each game played.

**38.3 Reports** – Reports shall be generated during the first and second intermissions (and subsequent intermissions during the playoffs) and post-game for each game played. Reports are distributed to the home club's Public Relations representative by the Scoring System Manager or his/her designate. The home club's Public Relations representative shall distribute reports to the media (print/radio/tv) and to each club's Coaches.

## **Rule 39 – Video Goal Judge**

**39.1 General Duties** – The following are the general duties of the Video Goal Judge:

- (i) *He will review replays of disputed goals when requested to do so by the Referees.*
- (ii) *He will review replays of disputed goals when he observes an incident that was undetected by on-ice officials.*
- (iii) *After viewing the incident he will promptly convey his decision directly to the Referee at the penalty bench. When a play has been referred to the Video Goal Judge, his decision shall be final.*
- (iv) *During the review he may consult with a member of the League's Hockey Operations or Officiating department staff if latter is in attendance at the game (or via telephone).*
- (v) *Any potential goal requiring video review must be reviewed prior to or during the next stoppage of play. No goal may be awarded (or disallowed) as a result of video review once the puck has been*



*dropped and play has resumed.*

**39.2 Goals** – Every goal is to be reviewed by the Video Goal Judge.

Upon making contact with the off-ice official at ice level, the Video Goal Judge should say initially that he is “looking at the play”. If there is a need to delay the resumption of the play, the off-ice official at ice level should signal one of the Referees to delay the center ice face-off for a moment. Once the Video Goal Judge has reviewed the video and confirmed that the goal is valid, he should say that “it is a good goal”. The off-ice official will then signal to the Referee to resume play.

If there is a need to expand the review, the Video Goal Judge will advise the off-ice official at ice level and the Public Address Announcer that the “play is under review”. Once the play has been reviewed and deemed a goal, the goal will be announced in the normal manner. If the review reveals that the goal must be disallowed, the Public Address Announcer shall announce the reason for the disallowed goal as reported by the Referee.

When the Video Goal Judge observes an incident involving a potential goal that was undetected by the on-ice officials he will contact the Referee at the first stoppage of play and inform him that a review of the play is in progress.

When a review is requested by either the Referee or Video Goal Judge, the Public Address Announcer shall make the following announcement: “The play is under review”.

The Video Goal Judge will use all the facilities at his disposal to review the incident and reach a conclusion as to the accurate time of the goal. It is the responsibility of the Video Goal Judge to record the time of the disputed goal and the clock is to be reset accordingly.

He will report his findings to the Referee as quickly as possible ensuring all available video feeds and angles have been reviewed.

When the Referee indicates there is to be a video review, all players (with the exception of the goalkeepers) will go to their respective players' bench immediately and failure to do so would result in a game misconduct penalty with a fine to the Coach.

**39.3 Reports** - Following every game, the Video Goal Judge must call the National Hockey League Toronto office and provide a verbal report of all video reviews conducted during the game.

Video Goal Judge reports are to be faxed or sent electronically to the National Hockey League Toronto office immediately following the game.

**39.4 Situations Subject to Video Review** - The following situations are subject to review by the Video Goal Judge:

- (i) *Puck crossing the goal line.*
- (ii) *Puck in the net prior to the goal frame being dislodged.*
- (iii) *Puck in the net prior to, or after expiration of time at the end of the*



period.

- (iv) *Puck directed or batted into the net by a hand or foot or deliberately batted with any part of the attacking player's body. With the use of a foot/skate, was a distinct kicking motion evident? If so, the apparent goal must be disallowed. A DISTINCT KICKING MOTION is one which, with a pendulum motion, the player propels the puck with his skate into the net. If the Video Goal Judge determines that it was put into the net by an attacking player using a distinct kicking motion, it must be ruled NO GOAL. This would also be true even if the puck, after being kicked, deflects off any other player of either team and then into the net. This is still NO GOAL. See also 49.2.*
- (v) *Puck deflected directly into the net off an Official.*
- (vi) *Puck struck with a high-stick, above the height of the crossbar, by an attacking player prior to entering the goal. The determining factor is where the puck makes contact with the stick in relation to the crossbar. If the puck makes contact with the portion of the stick that is at or below the level of the crossbar and enters the goal, this goal shall be allowed.*
- (vii) *To establish the correct time on the official game clock, provided the game time is visible on the Video Goal Judge's monitors.*
- (viii) *The video review process shall be permitted to assist the referees in determining the legitimacy of all potential goals (e.g. to ensure they are "good hockey goals"). For example (but not limited to), pucks that enter the net by going through the net meshing, pucks that enter the net from underneath the net frame, etc.*

**39.5 Logistics and Equipment** - The Video Goal Judge must be located in a secluded area in the upper level of the building with an unobstructed view of both goals. The location must be large enough to seat three people (Video Goal Judge, Video Technician and Supervisor of Officials) and have space for necessary monitors, replay and recording equipment.

The Video Goal Judge shall have access to all replays that may be available by reason of any telecasts of the game and if there is no scheduled telecast the Club's internal telecast of the game will be used.

The Video Goal Judge must be supplied with a phone or communication system with direct contact to the penalty bench.

The "burn in" of the game clock is mandatory for the two overhead goal video feeds, and should be available on all feeds if such can be provided by the host broadcaster.

**39.6 Verification of Time** - Any loss of time on the game or penalty clocks due to a false face-off must be replaced. The Video Goal Judge may be consulted to ensure the time is accurately replaced.

In the event of any dispute regarding time, the matter shall be referred to the Referee for adjustment and his decision shall be final. The Game Timekeeper shall assist to verify game time via an additional timing device. (NHL approved stop watch)



In accordance with Rule 39 – Video Goal Judge, the Officials may use the Video Goal Judge system to establish the correct time on the official game clock, provided the game time is visible on the Video Goal Judge's monitors.

In the event that a video replay shows a goal was scored prior to the play being stopped, the Video Goal Judge will inform the Game Timekeeper and Official Scorer of the time of goal and the amount of playing time left to be reset on the game clock and penalty time clocks (if applicable).

Should the first stoppage of play following an apparent goal coincide with the end of a period, the on-ice officials must instruct both teams to remain at their respective players' benches until the video review has been completed.

## **Rule 40 – Abuse of Officials**

**40.1 General Description** – A player, goalkeeper, Coach or non-playing person shall not challenge or dispute the rulings of an official before, during or after a game. A player, goalkeeper, Coach or non-playing person shall not display unsportsmanlike conduct including, but not limited to, obscene, profane or abusive language or gestures, comments of a personal nature intended to degrade an official, or persist in disputing a ruling after being told to stop or after being penalized for such behavior.

NOTE: When such conduct is directed at anyone other than an official, Rule 75 – Unsportsmanlike Conduct shall be applied.

**40.2 Minor Penalty** – A minor penalty for unsportsmanlike conduct shall be assessed under this rule for the following infractions:

- (i) *Any player who challenges or disputes the ruling of an official.*
- (ii) *Any identifiable player who uses obscene, profane or abusive language or gestures directed at any on or off-ice official.*
- (iii) *Any player or players who bang the boards with their sticks or other objects at any time, or who, in any manner show disrespect for an official's decision. If this is done in order to get the attention of the on-ice officials for a legitimate reason (i.e. serious injury, illness, etc.), then discretion must be exercised by the Referees.*
- (iv) *When a Captain, Alternate Captain or any other player comes off the players' bench to question or protest a ruling by an official on the ice.*
- (v) *If a player bangs the glass in protest of the Goal Judge's ruling. If he persists, a misconduct penalty would then be assessed.*
- (vi) *If a penalized player is assessed an additional unsportsmanlike conduct penalty either before or after he begins serving his original penalty(ies), the additional minor penalty is added to his unexpired time and served consecutively.*

**40.3 Bench Minor Penalty** - A bench minor penalty for unsportsmanlike conduct shall be assessed under this rule for the following infractions:



- (i) *Any Coach or non-playing person who bangs the boards with a stick or other object at any time, showing disrespect for an official's decision. If this is done in order to get the attention of the on-ice officials for a legitimate reason (i.e. serious injury, illness, etc.), then discretion must be exercised by the Referees.*
- (ii) *Any unidentifiable player or any Coach or non-playing person who uses obscene, profane or abusive language or gesture directed at an on or off-ice official or uses the name of any official coupled with any vociferous remarks. (see also 40.5 (ii))*
- (iii) *Any player, Coach, or non-playing person interferes in any manner with any game official including the Referees, Linesmen, Game or Penalty Timekeepers or Goal Judges in the performance of their duties.*

**40.4 Misconduct Penalty** – Misconduct penalties shall be assessed under this rule for the following infractions:

- (i) *Any player who persists in the use of obscene, profane or abusive language towards any on or off-ice official for which he has already been assessed a minor or bench minor penalty for unsportsmanlike conduct.*
- (ii) *Any player who intentionally knocks or shoots the puck out of the reach of an official who is retrieving it.*
- (iii) *Any player who, after being assessed an unsportsmanlike conduct minor penalty, persists in challenging or disputing the ruling of an official.*
- (iv) *Any player or players who bang the boards with their sticks or other objects at any time, showing disrespect for an official's decision, for which they have already been assessed a minor or bench minor penalty for unsportsmanlike conduct.*
- (v) *Any player or players who, except for the purpose of taking their positions on the penalty bench, enter or remain in the Referee's crease while he is reporting to or consulting with any game official including the other Referee, the Linesmen, Game Timekeeper, Penalty Timekeeper, Official Scorer or Public Address Announcer.*
- (vi) *A misconduct penalty (or game misconduct penalty at the discretion of the Referee) shall be imposed on any player who deliberately throws any equipment out of the playing area. When this is done in protest of an official's ruling, a minor penalty plus a game misconduct shall be assessed (see 40.5).*
- (vii) *Any player who, after previously being assessed a minor penalty for unsportsmanlike conduct for banging the glass in protest of the Goal Judge's ruling.*
- (viii) *In general, participants displaying this type of behaviour are assessed a minor penalty, then a misconduct penalty and then a game misconduct penalty if they persist.*

**40.5 Game Misconduct Penalty** – Game misconduct penalties shall be assessed under this rule for the following infractions:

- (i) *Any player who, after being assessed a misconduct penalty, persists in challenging or disputing the ruling of an official.*





- (ii) *When a player, Coach or non-playing person uses obscene, profane or abusive language or gesture directed at any on or off-ice official or uses the name of any official coupled with any vociferous remarks, after already being assessed a bench minor penalty (40.3 (ii)), this Coach or non-playing person is to be assessed a game misconduct and the situation reported to the Commissioner for further action. When this type of conduct occurs after the expiration of the game, on or off the ice, the game misconduct shall be applied without the necessity of having been assessed a bench minor penalty previously.*
- (iii) *Any player who deliberately applies physical force in any manner against an official, in any manner attempts to injure an official, physically demeans, or deliberately applies physical force to an official solely for the purpose of getting free of such an official during or immediately following an altercation shall receive a game misconduct penalty and the guidelines set out in Rule 41 – Physical Abuse of Officials are to be applied.*
- (iv) *Any player who, having entered the penalty bench, leaves the penalty bench prior to the expiration of his penalty for the purpose of challenging an official's ruling, shall be assessed a game misconduct penalty. He shall also be automatically suspended for the next three (3) regular League and/or Play-off games of his Club. This rule does not replace any other more severe penalty that may be imposed for leaving the penalty bench for the purpose of starting or participating in an altercation. See Rule 70 – Leaving the Bench.*
- (v) *A minor penalty for unsportsmanlike conduct plus a game misconduct shall be imposed on a player who throws his stick or any part thereof, or any other piece of equipment or object outside the playing area in protest of an official's decision.*
- (vi) *Any player, Coach or non-playing person who throws or shoots any equipment or other object in the general direction of an official but does not come close to making any contact. This action may occur on or off the ice.*
- (vii) *In general, participants displaying this type of behaviour are assessed a minor penalty, then a misconduct penalty and then a game misconduct penalty if they persist.*

Any player, Coach or non-playing Club personnel penalized under this section may be subject to supplemental discipline under Rule 29.

**40.6 Reports** - It is the responsibility of all game officials and all club officials to send a confidential report to the Commissioner setting out the full details concerning the use of obscene gestures or language by any player, Coach or non-playing Club personnel. The Commissioner shall take such further disciplinary action as he shall deem appropriate.

## **Rule 41 – Physical Abuse of Officials**

**41.1 Game Misconduct** - Any player who deliberately applies physical force in any manner against an official, in any manner attempts to injure an official, physically demeans, or deliberately applies physical force to an official solely for the purpose of getting free of such an



official during or immediately following an altercation shall receive a game misconduct penalty. In addition, the following (41.2, 41.3, 41.4) disciplinary penalties shall apply.

- 41.2 Automatic Suspension – Category I** - Any player who deliberately strikes an official and causes injury or who deliberately applies physical force in any manner against an official with intent to injure, or who in any manner attempts to injure an official shall be automatically suspended for not less than twenty (20) games. (For the purpose of the rule, “intent to injure” shall mean any physical force which a player knew or should have known could reasonably be expected to cause injury.)
- 41.3 Automatic Suspension – Category II** - Any player who deliberately applies physical force to an official in any manner (excluding actions as set out in Category I), which physical force is applied without intent to injure, or who spits on an official, shall be automatically suspended for not less than ten (10) games.
- 41.4 Automatic Suspension – Category III** - Any player who, by his actions, physically demeans an official or physically threatens an official by (but not limited to) throwing a stick or any other piece of equipment or object at or in the general direction of an official, shooting the puck at or in the general direction of an official, spitting at or in the general direction of an official, or who deliberately applies physical force to an official solely for the purpose of getting free of such an official during or immediately following an altercation shall be suspended for not less than three (3) games.
- 41.5 Automatic Suspension – Process** - Immediately after the game in which such game misconduct penalty is imposed, the Referees shall, in consultation with the Linesmen, decide the category of the offense. They shall make a verbal report to the League’s Director of Hockey Operations and advise of the category and of the offense. In addition, they shall file a written report to the Director of Hockey Operations in which they may request a review as to the adequacy of the suspension. The NHLPA, the player and the Club involved shall be notified of the decision of the Referees on the morning following the game. The League will then hold a conference call with the NHLPA to review the Referees application of this rule, and will refrain from issuing public comment affirming the Referees application of Rule 41 until that call is complete.

The player or the officials may request the Commissioner to review, subject to the provisions of this rule, the penalty imposed by the Referees. Such request must be filed with the Commissioner in writing not later than seventy-two (72) hours following notification of the penalty.

If a review of the incident is requested by either the player or by the officials, a hearing will be conducted by the Commissioner on an expedited basis, and best efforts will be used to provide a hearing before the second game missed by the player due to the automatic suspension imposed under this rule. The player’s suspension shall



continue pending the outcome of the hearing by the Commissioner.

For Category III offenses only, the Commissioner may conduct the hearing by telephone. For Category I and II offenses, the hearing shall be conducted in person.

After any review as called for hereby, the Commissioner shall issue an order that:

- (i) *sustaining the minimum suspension, or*
- (ii) *increasing the number of games within the category, or*
- (iii) *changing to a lower category, or*
- (iv) *changing to a lower category and increasing the number of games within this category, or*
- (v) *in the case of a Category III suspension only, reducing the number of games of the suspension.*

The penalties imposed under this rule shall not be deemed to limit the right of the Commissioner with respect to any action that he might otherwise take pursuant to Article 18 of the CBA.

- 41.6 **Supplementary Discipline** - In the event that the player has committed more than one offense under this rule, in addition to the penalties imposed under this offense, his case shall be referred to the Commissioner of the League for consideration of supplementary disciplinary action.
- 41.7 **Coach or Non-Playing Club Personnel** - Any Manager, Coach or non-playing Club personnel who holds or strikes an official shall be automatically suspended from the game, ordered to the dressing room and the matter will be reported to the Commissioner for further disciplinary action.
- 41.8 **Police Protection and Security** - All Clubs shall provide adequate police or other protection for all players, goalkeepers and officials at all times.

The Referee shall report to the Commissioner any failure of this protection observed by him or reported to him with particulars of such failure.



## SECTION 6 – PHYSICAL FOULS

### Rule 42 - Boarding

**42.1 Boarding** – A boarding penalty shall be imposed on any player who checks an opponent in such a manner that causes the opponent to be thrown violently in the boards. The severity of the penalty, based upon the degree of violence of the impact with the boards, shall be at the discretion of the Referee.

There is an enormous amount of judgment involved in the application of this rule by the Referees. The onus is on the player applying the check to ensure his opponent is not in a vulnerable position and if so, he must avoid the contact. However, there is also a responsibility on the player with the puck to avoid placing himself in a dangerous and vulnerable position. This balance must be considered by the Referees when applying this rule.

Any unnecessary contact with a player playing the puck on an obvious “icing” or “off-side” play which results in that player being knocked into the boards is “boarding” and must be penalized as such. In other instances where there is no contact with the boards, it should be treated as “charging.”

**42.2 Minor Penalty** – The Referee, at his discretion, may assess a minor penalty, based on the degree of violence of the impact with the boards, to a player guilty of boarding an opponent.

**42.3 Major Penalty** – The Referee, at his discretion, may assess a major penalty, based on the degree of violence of the impact with the boards, to a player guilty of boarding an opponent (see **42.5**).

**42.4 Match Penalty** – The Referee, at his discretion, may assess a match penalty if, in his judgment, the player attempted to or deliberately injured his opponent by boarding.

**42.5 Game Misconduct Penalty** - When a major penalty is imposed under this rule for a foul resulting in an injury to the face or head of an opponent, a game misconduct shall be imposed.

**42.6 Fines and Suspensions** - Any player who incurs a total of two (2) game misconducts under Rule **42** and/or Rule **44**, in either Regular season or Play-offs, shall be suspended automatically for the next game of his team. For each subsequent game misconduct penalty the automatic suspension shall be increased by one game.

When a major penalty is imposed under this rule, an automatic fine of one hundred dollars (\$100) shall be imposed.

If deemed appropriate, supplementary discipline can be applied by the Commissioner at his discretion (refer to Rule **29**).



## **Rule 43 - Charging**

43.1 **Charging** - A minor or major penalty shall be imposed on a player who skates or jumps into, or charges an opponent in any manner.

Charging shall mean the actions of a player who, as a result of distance traveled, shall violently check an opponent in any manner. A “charge” may be the result of a check into the boards, into the goal frame or in open ice.

A minor, major or a major and a game misconduct shall be imposed on a player who charges a goalkeeper while the goalkeeper is within his goal crease.

A goalkeeper is not “fair game” just because he is outside the goal crease area. The appropriate penalty should be assessed in every case where an opposing player makes unnecessary contact with a goalkeeper. However, incidental contact, at the discretion of the Referee, will be permitted when the goalkeeper is in the act of playing the puck outside his goal crease provided the attacking player has made a reasonable effort to avoid such contact.

43.2 **Minor Penalty** - The Referee, at his discretion, may assess a minor penalty, based on the degree of violence of the check, to a player guilty of charging an opponent.

43.3 **Major Penalty** – The Referee, at his discretion, may assess a major penalty, based on the degree of violence of the check, to a player guilty of charging an opponent (see **43.5**).

43.4 **Match Penalty** – The Referee, at his discretion, may assess a match penalty if, in his judgment, the player attempted to or deliberately injured his opponent by charging.

43.5 **Game Misconduct Penalty** - When a major penalty is imposed under this rule for a foul resulting in an injury to the face or head of an opponent, a game misconduct shall be imposed.

43.6 **Fines and Suspensions** – When a major penalty and a game misconduct is assessed for a foul resulting in an injury to the face or head of an opponent, an automatic fine of one hundred dollars (\$100) shall be imposed.

If deemed appropriate, supplementary discipline can be applied by the Commissioner at his discretion (refer to Rule **29**).

## **Rule 44 – Checking from Behind**

44.1 **Checking from Behind** – A check from behind is a check delivered on a player who is not aware of the impending hit, therefore unable to protect or defend himself, and contact is made on the back part of the body. When a player intentionally turns his body to create contact with his back, no penalty shall be assessed.

44.2 **Minor Penalty** - There is no provision for a minor penalty for checking from behind.



- 44.3 **Major Penalty** – Any player who cross-checks, pushes or charges from behind an opponent who is unable to protect or defend himself, shall be assessed a major penalty. This penalty applies anywhere on the playing surface (see 44.5).
- 44.4 **Match Penalty** - The Referee, at his discretion, may assess a match penalty if, in his judgment, the player attempted to or deliberately injured his opponent by checking from behind.
- 44.5 **Game Misconduct** – A game misconduct penalty must be assessed anytime a major penalty is applied for checking from behind.
- 44.6 **Fines and Suspensions** - Any player who incurs a total of two (2) game misconducts under Rule 42 and/or Rule 44, in either the Regular season or Play-offs, shall be suspended automatically for the next game of his team. For each subsequent game misconduct penalty the automatic suspension shall be increased by one game.

If deemed appropriate, supplementary discipline can be applied by the Commissioner at his discretion (refer to Rule 29).

## **Rule 45 - Clipping**

- 45.1 **Clipping** - Clipping is the act of throwing the body, from any direction, across or below the knees of an opponent.

A player may not deliver a check in a “clipping” manner, nor lower his own body position to deliver a check on or below an opponent’s knees.

An illegal “low hit” is a check that is delivered by a player who may or may not have both skates on the ice, with his sole intent to check the opponent in the area of his knees. A player may not lower his body position to deliver a check to an opponent’s knees.

- 45.2 **Minor Penalty** - A player who commits these fouls will be assessed a minor penalty for “clipping.”
- 45.3 **Major Penalty** - If an injury occurs as a result of this “clipping” check, the player must be assessed a major penalty (see 45.5).
- 45.4 **Match Penalty** - The Referee, at his discretion, may assess a match penalty if, in his judgment, the player attempted to or deliberately injured his opponent by clipping.
- 45.5 **Game Misconduct Penalty** - A game misconduct penalty must be assessed anytime a major penalty is applied for injuring an opponent by clipping.
- 45.6 **Fines and Suspensions** – There are no specified fines or suspensions for clipping, however, supplementary discipline can be applied by the Commissioner at his discretion (refer to Rule 29).



## **Rule 46 - Elbowing**

- 46.1 **Elbowing** - Elbowing shall mean the use of an extended elbow in a manner that may or may not cause injury.
- 46.2 **Minor Penalty** - The Referee, at his discretion, may assess a minor penalty, based on the degree of violence, to a player guilty of elbowing an opponent.
- 46.3 **Major Penalty** - A major penalty, at the discretion of the Referee, shall be imposed on any player who uses his elbow to foul an opponent. A major penalty must be imposed under this rule for a foul resulting in an injury to the face or head of an opponent (see **46.5**).
- 46.4 **Match Penalty** - The Referee, at his discretion, may assess a match penalty if, in his judgment, the player attempted to or deliberately injured his opponent by elbowing.
- 46.5 **Game Misconduct Penalty** - When a major penalty is imposed under this rule for a foul resulting in an injury to the face or head of an opponent, a game misconduct penalty shall also be imposed.
- 46.6 **Fines and Suspensions** - When a major penalty and a game misconduct is assessed for a foul resulting in an injury to the face or head of an opponent, an automatic fine of one hundred dollars (\$100) shall be imposed.

If deemed appropriate, supplementary discipline can be applied by the Commissioner at his discretion (refer to Rule **29**).

## **Rule 47 - Fighting**

- 47.1 **Fighting** – A fight shall be deemed to have occurred when at least one player punches or attempts to punch an opponent repeatedly or when two players wrestle in such a manner as to make it difficult for the Linesmen to intervene and separate the combatants.

The Referees are provided very wide latitude in the penalties with which they may impose under this rule. This is done intentionally to enable them to differentiate between the obvious degrees of responsibility of the participants either for starting the fighting or persisting in continuing the fighting. The discretion provided should be exercised realistically.

- 47.2 **Aggressor** – The aggressor in an altercation shall be the player who continues to throw punches in an attempt to inflict punishment on his opponent who is in a defenseless position or who is an unwilling combatant.

A player must be deemed the aggressor when he has clearly won the fight but he continues throwing and landing punches in a further attempt to inflict punishment and/or injury on his opponent who is no longer in a position to defend himself.

A player who is deemed to be the aggressor of an altercation shall be assessed a major penalty for fighting and a game misconduct.



A player who is deemed to be the aggressor of an altercation will have this recorded as an aggressor of an altercation for statistical and suspension purposes.

A player who is deemed to be both the instigator and aggressor of an altercation shall be assessed an instigating minor penalty, a major penalty for fighting, a ten-minute misconduct (instigator) and a game misconduct penalty (aggressor).

**47.3 Altercation** - An altercation is a situation involving two players with at least one to be penalized.

**47.4 Clearing the Area of a Fight** - When a fight occurs, all players not engaged shall go immediately to the area of their players' bench and in the event the altercation takes place at a players' bench, the players on the ice from that team shall go to their defending zone. Goalkeepers shall remain in their goal crease, except in the event the altercation takes place in the vicinity of the goal crease, and therefore shall obey the directions of the Referee. Failure to comply can result in penalties incurred for their involvement in and around the area and fines as outlined in **47.18**.

**47.5 Continuing or Attempting to Continue a Fight** - Any player who persists in continuing or attempting to continue a fight or altercation after he has been ordered by the Referee to stop, or who resists a Linesman in the discharge of his duties shall, at the discretion of the Referee, incur a misconduct or game misconduct penalty in addition to any penalties imposed.

**47.6 Face Protection** - If a player penalized as an instigator of an altercation is wearing a face shield (including a goalkeeper), he shall be assessed an additional unsportsmanlike conduct penalty.

Should the player (including a goalkeeper) who instigates the fight be wearing a face shield, but removes it before instigating the altercation, the additional unsportsmanlike conduct penalty shall not apply.

**47.7 Fighting After the Original Altercation** - A game misconduct penalty shall be imposed on any player who is assessed a major penalty for fighting after the original altercation has started.

Notwithstanding this rule, at the discretion of the Referee, the automatic game misconduct penalty may be waived for a player in the altercation if the opposing player was clearly the instigator of the altercation.

**47.8 Fighting Off the Playing Surface** - A misconduct or game misconduct penalty shall be imposed on any player involved in fighting off the playing surface or with another player who is off the playing surface. These penalties are in addition to any other time penalties assessed, including the major penalty for fighting.

Whenever a Coach or other non-playing Club personnel becomes involved in an altercation with an opposing player, Coach or other non-playing Club personnel on or off the ice, shall be automatically suspended from the game, ordered to the dressing room and the





matter will be reported to the Commissioner for further disciplinary action.

- 47.9 Fighting Other Than During the Periods of the Game** - Any teams whose players become involved in an altercation, other than during the periods of the game, shall be fined pursuant to **47.20**, in addition to any other appropriate penalties that may be imposed upon the participating players by supplementary discipline or otherwise.

Players involved in fighting other than during the periods of the game shall be assessed a major penalty and a game misconduct. Should one player be deemed the instigator of the fight, the game misconduct shall not be assessed to his opponent.

Any player who would be deemed to be an instigator pursuant to this rule at a time other than during the periods of the game shall be suspended pursuant to **47.20**.

In the case of altercations taking place after the period or game the fine under this rule shall be assessed only in the event that an altercation is commenced after the period or game has terminated.

Should players come onto the ice from their players' benches after the period ends and prior to the start of an altercation, they shall not be penalized if they remain in the vicinity of their players' bench and provided they do not get involved in any altercations.

- 47.10 Fighting Prior to the Drop of the Puck** – Unless this occurs prior to the start of the game or any period (see **47.9**), a fight that occurs prior to the drop of the puck during the course of normal face-off, the altercation shall be penalized as if it occurred during the regular playing time.

When, in the opinion of the Referee that, specific personnel changes have been made by one or both teams late in a game and ultimately an altercation ensues, the appropriate penalties are to be assessed and the incident reported to the Commissioner immediately following the game for review and possible supplementary discipline under Rule **29**.

- 47.11 Instigator** - An instigator of an altercation shall be a player who by his actions or demeanor demonstrates any/some of the following criteria: distance traveled; gloves off first; first punch thrown; menacing attitude or posture; verbal instigation or threats; conduct in retaliation to a prior game (or season) incident; obvious retribution for a previous incident in the game or season.

A player who is deemed to be the instigator of an altercation shall be assessed an instigating minor penalty, a major penalty for fighting and a ten-minute misconduct.

If the same player is deemed to be the instigator of a second altercation in the same game, he shall be assessed an instigating minor penalty, a major penalty for fighting and a game misconduct.



When a player receives his third instigator penalty in one Regular season, he is automatically given a game misconduct following that third violation.

A player who is deemed to be both the instigator and aggressor of an altercation shall be assessed an instigating minor penalty, a major penalty for fighting, a ten-minute misconduct (instigator) and a game misconduct penalty (aggressor).

Any request by a Club to have an instigator penalty reviewed and rescinded by the League must follow the same procedure for game misconduct penalties as outlined in **23.2**.

**47.12 Instigator in Final Five Minutes of Regulation Time (or Anytime in Overtime)** - A player who is deemed to be the instigator of an altercation in the final five (5) minutes of regulation time or at any time in overtime shall be assessed an instigator minor penalty, a major penalty for fighting, and a game misconduct penalty, subject to the conditions outlined in **47.22**.

**47.13 Jerseys** - A player who deliberately removes his jersey prior to participating in an altercation or who is clearly wearing a jersey that has been modified and does not conform to Rule **9** – Uniforms, shall be assessed a minor penalty for unsportsmanlike conduct and a game misconduct. This is in addition to other penalties to be assessed to the participants of an altercation. If the altercation never materializes, the player would receive a minor penalty for unsportsmanlike conduct and a ten-minute misconduct for deliberately removing his jersey.

A player who engages in a fight and whose jersey is removed (completely off his torso), other than through the actions of his opponent in the altercation or through the actions of the Linesman, shall be assessed a game misconduct penalty.

A player who engages in a fight and whose jersey is not properly “tied-down” (jersey properly fastened to pants), and who loses his jersey (completely off his torso) in that altercation, shall receive a game misconduct penalty. If the player loses his jersey despite the tie down remaining in tact and attached to the pants, the game misconduct is not applicable, however this must be reported to the League office so that the jersey and the tie down can be examined.

A player who is involved in an altercation, when the opponent has been identified as an instigator, shall not be assessed a game misconduct penalty if his jersey should be removed by an opponent or an official in the discharge of his duties, regardless as to whether or not he was properly “tied-down” (jersey properly fastened to pants).

**47.14 Major Penalty** – A major penalty shall be imposed on any player who fights.

**47.15 Match Penalty** - Any player wearing tape or any other material on his hands (below the wrist) who cuts or injures an opponent during an altercation will receive a match penalty in addition to any other penalties imposed including for fighting under this rule.



A match penalty shall be assessed to a player who punches an unsuspecting opponent and causes an injury.

- 47.16 Third Man In** - A game misconduct penalty, at the discretion of the Referee, shall be imposed on any player who is the first to intervene (third man in) in an altercation already in progress except when a match penalty is being imposed in the original altercation. This penalty is in addition to any other penalties incurred in the same incident.

This rule also applies to subsequent players who elect to intervene in the same or other altercations during the same stoppage of play.

Generally, this rule is applied when a fight occurs.

- 47.17 Fines and Suspensions – Aggressor** – (see 47.2) A player who is deemed to be the aggressor for the third time in one Regular season shall be suspended for the next two regular season games of his team.

For the fourth aggressor penalty in the same Regular season, the player will be suspended for the next four games of his team. For the fifth aggressor penalty in the same Regular season, the player will be suspended for the next six games of his team.

During the Play-offs, any player who is deemed to be the aggressor for the second time shall be suspended automatically for the next Play-off game of his team. For each subsequent aggressor violation during the Play-offs, the automatic suspension shall be increased by one game.

Prior to the commencement of each Stanley Cup Final, a player will have his current aggressor violations removed from his current playoff record. They will remain part of his historical record.

- 47.18 Fines and Suspensions – Clearing the Area of a Fight** - Failure by players (or goalkeepers as required) to clear the area of a fight shall, in addition to the other penalties that may be assessed, result in a fine to the team of \$1,000 and the Coach of said team in the amount of \$1,000.

- 47.19 Fines and Suspensions – Failure to Proceed Directly to Penalty Bench** - Any player who, following a fight or other altercation in which he has been involved is broken up and for which he is penalized, fails to proceed directly and immediately to the penalty bench, or who causes any delay by retrieving his equipment (gloves, sticks, etc. shall be delivered to him at the penalty bench by teammates), shall incur an automatic fine of one hundred dollars (\$100) in addition to all other penalties or fines incurred.

- 47.20 Fines and Suspensions – Fighting Other Than During the Periods of the Game** - Any teams whose players become involved in an altercation, other than during the periods of the game (see 47.9), shall be fined automatically twenty-five thousand dollars (\$25,000) in addition to any other appropriate penalties that may be imposed upon the participating players by supplementary discipline or otherwise.

Any player who would be deemed to be an instigator pursuant to



this rule at a time other than during the periods of the game shall be suspended automatically for ten (10) games. Such determination may be made by the Referee at the time of the incident or subsequently by the Commissioner or his designee based upon such reports and other information as he deems sufficient, including but not limited to television tapes.

**47.21 Fines and Suspensions – Instigator** - A player who is deemed to be the instigator of an altercation (see **47.11**) for the third time in one Regular season shall be suspended for the next two regular season games of his team.

For the fourth instigator penalty in the same Regular season, the player will be suspended for the next four games of his team. For the fifth instigator penalty in the same Regular season, the player will be suspended for the next six games of his team.

During the Play-offs, any player who is deemed to be the instigator of an altercation for the second time shall be suspended automatically for the next Play-off game of his team. For each subsequent instigator violation during the Play-offs, the automatic suspension shall be increased by one game.

Prior to the commencement of each Stanley Cup Final, a player will have his current instigator violations removed from his current playoff record. They will remain part of his historical record.

**47.22 Fines and Suspensions – Instigator in Final Five Minutes of Regulation Time (or Anytime in Overtime)** - A player who is deemed to be the instigator of an altercation in the final five (5) minutes of regulation time or at anytime in overtime (see **47.12**), shall be suspended for one game, pending a review of the incident.

When the one-game suspension is imposed, the Coach shall be fined \$10,000 – a fine that will double for each subsequent incident.

The suspension shall be served unless, upon review of the incident, the Director of Hockey Operations, at his discretion, deems the incident is not related to the score, previous incidents in the game or prior games, retaliatory in nature, “message sending”, etc. The length of suspension will double for each subsequent offense. This suspension shall be served in addition to any other automatic suspensions a player may incur for an accumulation of three or more instigator penalties.

No team appeals will be permitted either verbally or in writing regarding the assessment of this automatic suspension as all incidents are reviewed by the Director of Hockey Operations as outlined above.



## **Rule 48 – Head-butting**

- 48.1 **Head-butting** – The act of head-butting involves a player making intentional contact, or attempting to make contact, with an opponent by leading with his head and/or helmet.
- 48.2 **Double-minor Penalty** - A double-minor penalty shall be imposed on a player who attempts to head-butt an opponent.
- 48.3 **Major Penalty** - A major penalty shall be imposed on a player who head-butts an opponent (see 48.5).
- 48.4 **Match Penalty** - A match penalty shall be imposed on a player who injures an opponent as a result of a head-butt.
- 48.5 **Game Misconduct Penalty** – When a major penalty is assessed under this rule, a game misconduct penalty must be imposed.
- 48.6 **Fines and Suspensions** - There are no specified fines or suspensions for head-butting, however, supplementary discipline can be applied by the Commissioner at his discretion (refer to Rule 29).

## **Rule 49 - Kicking**

- 49.1 **Kicking** – The action of a player deliberately using his skate(s) with a kicking motion to propel the puck or to contact an opponent.
- 49.2 **Goals** - Kicking the puck shall be permitted in all zones. A goal cannot be scored by an attacking player who uses a distinct kicking motion to propel the puck into the net. A goal cannot be scored by an attacking player who kicks a puck that deflects into the net off any player, goalkeeper or official.

A puck that deflects into the net off an attacking player's skate who does not use a distinct kicking motion is a legitimate goal. A puck that is directed into the net by an attacking player's skate shall be a legitimate goal as long as no distinct kicking motion is evident. The following should clarify deflections following a kicked puck that enters the goal:

- (i) *A kicked puck that deflects off the body of any player of either team (including the goalkeeper) shall be ruled no goal.*
- (ii) *A kicked puck that deflects off the stick of any player (excluding the goalkeeper's stick) shall be ruled a good goal.*
- (iii) *A goal will be allowed when an attacking player kicks the puck and the puck deflects off his own stick and then into the net.*

A goal cannot be scored by an attacking player who kicks any equipment (stick, glove, helmet, etc.) at the puck, including kicking the blade of his own stick, causing the puck to cross the goal line.

- 49.3 **Match Penalty** – A match penalty shall be imposed on any player who kicks or attempts to kick another player.

Whether or not an injury occurs, the Referee will impose a five (5) minute time penalty under this rule.



49.4 **Fines and Suspensions** - There are no specified fines or suspensions for kicking and opponent, however, supplementary discipline can be applied by the Commissioner at his discretion (refer to Rule 29).

## **Rule 50 - Kneeing**

- 50.1 **Kneeing** - Kneeing is the act of a player leading with his knee and in some cases extending his leg outwards to make contact with his opponent.
- 50.2 **Minor Penalty** - The Referee, at his discretion, may assess a minor penalty, based on the severity of the infraction, to a player guilty of kneeling an opponent.
- 50.3 **Major Penalty** - The Referee, at his discretion, may assess a major penalty, based on the severity of the infraction, to a player guilty of kneeling an opponent (see 50.5).
- 50.4 **Match Penalty** – The Referee, at his discretion, may assess a match penalty if, in his judgment, the player attempted to or deliberately injured his opponent by kneeling.
- 50.5 **Game Misconduct Penalty** - When a player has been assessed a major penalty for kneeling he shall also be assessed a Game Misconduct.
- 50.6 **Fines and Suspensions** - There are no specified fines or suspensions for kneeling, however, supplementary discipline can be applied by the Commissioner at his discretion (refer to Rule 29).

## **Rule 51 - Roughing**

- 51.1 **Roughing** – Roughing is a punching motion with the hand or fist, with or without the glove on the hand, normally directed at the head or face of an opponent.
- Roughing is a minor altercation that is not worthy of a major penalty to either participant. (An altercation is a situation involving two players with at least one to be penalized).
- 51.2 **Minor Penalty** - A minor penalty shall be imposed on a player who strikes an opponent with his hand or fist.
- 51.3 **Match Penalty** - If, in the judgment of the Referee, a goalkeeper uses his blocking glove to punch an opponent in the head or face in an attempt to or to deliberately injure an opponent, a match penalty must be assessed.
- 51.4 **Fines and Suspensions** - There are no specified fines or suspensions for roughing, however, supplementary discipline can be applied by the Commissioner at his discretion (refer to Rule 29).



## **Rule 52 – Slew-footing**

- 52.1 **Slew-footing** - Slew-footing is the act of a player using his leg or foot to knock or kick an opponent's feet from under him, or pushes an opponent's upper body backward with an arm or elbow, and at the same time with a forward motion of his leg, knocks or kicks the opponent's feet from under him, causing him to fall violently to the ice.
- 52.2 **Match Penalty** - Any player who is guilty of slew-footing shall be assessed a match penalty.
- 52.3 **Fines and Suspensions** - There are no specified fines or suspensions for slew-footing, however, supplementary discipline can be applied by the Commissioner at his discretion (refer to Rule 29).

## **Rule 53 – Throwing Equipment**

- 53.1 **Throwing Equipment** – A player shall not throw a stick or any other object in any zone. A player who has lost or broken his stick may only receive a stick at his own players' bench or be handed one from a teammate on the ice (see 10.3).
- 53.2 **Minor Penalty** - A minor penalty shall be imposed on any player on the ice who throws his stick or any part thereof or any other object in the direction of the puck or an opponent in any zone, except when such act has been penalized by the assessment of a penalty shot or the awarding of a goal.

When a defending player shoots or throws a stick or any other object at the puck or the puck carrier in the defending zone but does not interfere in any manner with the puck or puck carrier, a minor penalty shall be assessed.

When the player discards the broken portion of a stick or some other object by tossing it or shooting it to the side of the ice (and not over the boards) in such a way as will not interfere with play or opposing player, no penalty will be imposed for so doing. When moving a stick that is not broken, no penalty shall be assessed as long as it does not interfere with the play and the player who lost said stick is not attempting to retrieve it, otherwise an interference penalty must be assessed.

A minor penalty for unsportsmanlike conduct plus a game misconduct penalty shall be imposed on a player who throws his stick or any part thereof or any other object or piece of equipment outside the playing area in protest of an official's decision.

- 53.3 **Bench Minor Penalty** – Should any player, Coach, or non-playing person on the players' bench or penalty bench throw anything on the ice during the progress of the game or during a stoppage of play, a bench minor penalty for unsportsmanlike conduct shall be assessed. See 75.3.
- 53.4 **Misconduct or Game Misconduct Penalty** - A misconduct penalty shall be imposed on a player who unintentionally or accidentally



throws his stick or any part thereof or any other object or piece of equipment outside the playing area. If the offense is committed intentionally, a game misconduct penalty shall be assessed to the offending player. If the offense is committed in protest of an official's decision, a minor penalty for unsportsmanlike conduct plus a game misconduct penalty shall be assessed to the offending player.

**53.5 Match Penalty** – If a player attempts to or deliberately injures an opponent by throwing a stick or any other object or piece of equipment at an opposing player, Coach or non-playing club person, he shall be assessed a match penalty. If injury results from the thrown object, a match penalty must be assessed for deliberate injury of an opponent.

**53.6 Penalty Shot** - When any member of the defending team, including the Coach or any non-playing person, throws or shoots any part of a stick or any other object or piece of equipment at the puck or puck carrier in his defending zone, the Referee shall allow the play to be completed and if a goal is not scored, a penalty shot shall be awarded to the non-offending team. This shot shall be taken by the player designated by the Referee as the player fouled.

If the officials are unable to determine the person against whom the offense was made, the non-offending team, through the Captain, shall designate a player on the ice at the time the offense was committed to take the shot.

If a player on a breakaway in the neutral or attacking zone is interfered with by a stick or any other object or piece of equipment that is thrown by any member of the defending team, including the Coach or any non-playing Club person, a penalty shot shall be awarded to the non-offending team. See also Rule **57.3** – Tripping for fouls from behind to a player on a breakaway.

If a player on a breakaway in the neutral or attacking zone is interfered with by an object thrown on the ice by a spectator that causes him to lose possession of the puck or to fall, the Referee shall award a penalty shot to the player who was fouled.

**53.7 Awarded Goal** - If, when the opposing goalkeeper has been removed, a member of the defending team, including the Coach or any non-playing person, throws or shoots any part of a stick or any other object or piece of equipment at the puck or puck carrier in the neutral or his own defending zone, thereby preventing the puck carrier from having a clear shot on an "open net", a goal shall be awarded to the attacking side.

For the purpose of this rule, an "open net" is defined as one from which a goalkeeper has been removed for an additional attacking player. The goalkeeper is considered off the ice once the replacement player has entered the playing surface.

**53.8 Fines and Suspensions** - There are no specified fines or suspensions for throwing equipment, however, supplementary discipline can be applied by the Commissioner at his discretion (refer to Rule **29**).





## SECTION 7 – RESTRAINING FOULS

### Rule 54 – Holding

54.1 **Holding** – Any action by a player that restrains or impedes the progress of an opposing player whether or not he is in possession of the puck.

54.2 **Minor Penalty** - A minor penalty shall be imposed on a player who holds an opponent by using his hands, arms or legs.

A player is permitted to use his arm in a strength move, by blocking his opponent, provided he has body position and is not using his hands in a holding manner, when doing so.

A player is not permitted to hold an opponent's stick. A minor penalty shall be assessed to a player who holds an opponent's stick (assessed and announced as "holding the stick").

A player is permitted to protect himself by defending against an opponent's stick. He must immediately release the stick and allow the player to resume normal play.

54.3 **Penalty Shot** – refer to Rule 57.3 – Tripping.

54.4 **Awarded Goal** – refer to Rule 57.4 – Tripping.

### Rule 55 – Hooking

55.1 **Hooking** - Hooking is the act of using the stick in a manner that enables a player to restrain an opponent.

When a player is checking another in such a way that there is only stick-to-stick contact, such action is not to be penalized as hooking.

55.2 **Minor Penalty** - A minor penalty shall be imposed on a player who impedes the progress of an opponent by "hooking" with his stick. A minor penalty for hooking shall be assessed to any player who uses the shaft of the stick above the upper hand to hold or hook an opponent.

55.3 **Major Penalty** - A major penalty shall be imposed on any player who injures an opponent by "hooking" (see 55.4).

55.4 **Game Misconduct** – When a major penalty has been assessed for hooking as a result of an injury to an opponent, a game misconduct penalty must also be assessed.

55.5 **Penalty Shot** – refer to Rule 57.3 – Tripping.

55.6 **Awarded Goal** – refer to Rule 57.4 – Tripping.

55.7 **Fines and Suspensions** - A player who has been assessed a major penalty and a game misconduct under this rule shall be automatically fined one hundred dollars (\$100).

If deemed appropriate, supplementary discipline can be applied by the Commissioner at his discretion (refer to Rule 29).



## **Rule 56 – Interference**

56.1 **Interference** - A strict standard on acts of interference must be adhered to in all areas of the rink.

**Body Position:** Body position shall be determined as the player skating in front of or beside his opponent, traveling in the same direction. A player who is behind an opponent, who does not have the puck, may not use his stick, body or free hand in order to restrain his opponent, but must skate in order to gain or reestablish his proper position in order to make a check.

A player is allowed the ice he is standing on (body position) and is not required to move in order to let an opponent proceed. A player may “block” the path of an opponent provided he is in front of his opponent and moving in the same direction. Moving laterally and without establishing body position, then making contact with the non-puck carrier is not permitted and will be penalized as interference. A player is always entitled to use his body position to lengthen an opponent’s path to the puck, provided his stick is not utilized (to make himself “bigger” and therefore considerably lengthening the distance his opponent must travel to get where he is going); his free hand is not used and he does not take advantage of his body position to deliver an otherwise illegal check.

**Possession of the Puck:**

The last player to touch the puck, other than the goalkeeper, shall be considered the player in possession. The player deemed in possession of the puck may be checked legally, provided the check is rendered immediately following his loss of possession.

**Restrain:** The actions of a player who does not have body position, but instead uses illegal means (e.g. hook with stick; hold with hands, trip with the stick or in any manner) to impede an opponent who is not in possession of the puck. Illegal means are acts which allow a player or goalkeeper to establish, maintain or restore body position other than by skating.

**Pick:** A “pick” is the action of a player who checks an opponent who is not in possession of the puck and is unaware of the impending check/hit. A player who is aware of an impending hit, not deemed to be a legal “battle for the puck,” may not be interfered with by a player or goalkeeper delivering a “pick.” A player delivering a “pick” is one who moves into an



opponent's path without initially having body position, thereby taking him out of the play. When this is done, an interference penalty shall be assessed.

**Free Hand:** When a free hand is used to hold, pull, tug, grab or physically restrain an opponent from moving freely, this must be penalized as holding. The free hand may be used by a player to "fend off" an opponent or his stick, but may not be used to hold an opponent's stick or body.

**Stick:** A player who does not have body position on his opponent, who uses his stick (either the blade or the shaft, including the butt-end of the shaft) to impede or prevent his opponent from moving freely on the ice shall be assessed a hooking penalty.

**56.2 Minor Penalty** - A minor penalty shall be imposed on a player who interferes with or impedes the progress of an opponent who is not in possession of the puck.

A minor penalty shall be imposed on a player who restrains an opponent who is attempting to "fore-check."

A minor penalty shall be imposed on an attacking player who deliberately checks a defensive player, including the goalkeeper, who is not in possession of the puck.

A minor penalty shall be imposed on a player who shall cause an opponent who is not in possession of the puck to be forced off-side, causing a stoppage in play. If this action causes a delayed off-side (and not necessarily a stoppage in play), then the application of a penalty for interference is subject to the judgment of the Referee.

A minor penalty shall be imposed on a player who deliberately knocks a stick out of an opponent's hand, or who prevents a player who has dropped his stick or any other piece of equipment from regaining possession of it.

A minor penalty shall be imposed on a player who knocks or shoots any abandoned or broken stick or illegal puck or other debris towards an opposing puck carrier in a manner that could cause him to be distracted. (See also Rule 53 – Throwing Equipment.)

A minor penalty shall be imposed on any identifiable player on the players' bench or penalty bench who, by means of his stick or his body, interferes with the movements of the puck or any opponent on the ice during the progress of the play. In addition, should a player about to come onto the ice, play the puck while one or both skates are still on the players' or penalty bench, a minor penalty for interference shall be assessed.

The appropriate penalty according to the playing rules shall be assessed when a player on the players' or penalty bench gets involved with an opponent on the ice during a stoppage in play. The player(s) involved may be subject to additional sanctions as



appropriate pursuant to Rule 29 – Supplementary Discipline.

- 56.3 **Bench Minor Penalty** - A bench minor penalty shall be imposed when an unidentifiable player on the players' bench or penalty bench or any Coach or non-playing Club personnel who, by means of his stick or his body, interferes with the movements of the puck or any opponent on the ice during the progress of the play.
- 56.4 **Major Penalty** - The Referee, at his discretion, may assess a major penalty, based on the degree of violence, to a player guilty of interfering with an opponent (see 56.5).
- 56.5 **Game Misconduct Penalty** – When a major penalty is imposed under this rule for a foul resulting in an injury of an opponent, a game misconduct shall be imposed.
- 56.6 **Penalty Shot** - When a player in control of the puck in the neutral or attacking zone and having no other opponent to pass than the goalkeeper is interfered with by a stick or any part thereof or any other object or piece of equipment thrown or shot by any member of the defending team including the Coach or non-playing Club personnel, a penalty shot shall be awarded to the non-offending team. When a Coach or non-playing Club personnel is guilty of such an act, he shall be automatically suspended from the game, ordered to the dressing room and the matter will be reported to the Commissioner for possible further disciplinary action.
- 56.7 **Awarded Goal** - If, when the goalkeeper has been removed from the ice, any member of his team (including the goalkeeper) not legally on the ice, including the Coach or non-playing Club personnel, interferes by means of his body, stick or any other object or piece of equipment with the movements of the puck or an opposing player in the neutral or attacking zone, the Referee shall immediately award a goal to the non-offending team. When a Coach or non-playing Club personnel is guilty of such an act, he shall be automatically suspended from the game, ordered to the dressing room and the matter will be reported to the Commissioner for possible further disciplinary action.

## **Rule 57 – Tripping**

- 57.1 **Tripping** – A player shall not place the stick, knee, foot, arm, hand or elbow in such a manner that causes his opponent to trip or fall.

Accidental trips which occur simultaneously with a completed play will not be penalized. Accidental trips occurring simultaneously with or after a stoppage of play will not be penalized.

If, in the opinion of the Referee, a player makes contact with the puck first and subsequently trips the opponent in so doing, no penalty shall be assessed.

- 57.2 **Minor Penalty** - A minor penalty shall be imposed on any player who shall place his stick or any portion of his body in such a manner that it



shall cause his opponent to trip and fall.

- 57.3 **Penalty Shot** - When a player, in the neutral or attacking zone, in control of the puck (or who could have obtained possession and control of the puck) and having no other opponent to pass than the goalkeeper, is tripped or otherwise fouled from behind, thus preventing a reasonable scoring opportunity, a penalty shot shall be awarded to the non-offending team. Nevertheless, the Referee shall not stop play until the attacking team has lost possession of the puck to the defending team.

The intention of this rule is to restore a reasonable scoring opportunity which has been lost. If, however, the player fouled is able to recover and obtain a reasonable scoring opportunity (or a teammate is able to gain a reasonable scoring opportunity), no penalty shot should be awarded but the appropriate penalty should be signaled and assessed if a goal is not scored on the play.

“Control of the puck” means the act of propelling the puck with the stick, hand or feet. If while it is being propelled, the puck is touched by another player or his equipment, or hits the goal or goes free, the player shall no longer be considered to be “in control of the puck”.

In order for a penalty shot to be awarded for a player being fouled from behind, the following four (4) criteria must have been met:

- (i) *The infraction must have taken place in the neutral or attacking zone (i.e. over the puck carrier's own blue line).*
- (ii) *The infraction must have been committed from behind.*
- (iii) *The player in possession and control (or, in the judgment of the Referee, the player clearly would have obtained possession and control of the puck) must have been denied a reasonable chance to score. The fact that the player got a shot off does not automatically eliminate this play from the penalty shot consideration criteria. If the foul was from behind and the player was denied a “more” reasonable scoring opportunity due to the foul, then the penalty shot should still be awarded.*
- (iv) *The player in possession and control (or, in the judgment of the Referee, the player clearly would have obtained possession and control) must have had no opposing player between himself and the goalkeeper.*

It should be noted that if the attacking player manages to get around the goalkeeper and has no defending player between him and the open goal, and he is fouled from behind by the goalkeeper or another defending player, no goal can be awarded since the goalkeeper is still on the ice. A penalty shot would be awarded.

- 57.4 **Awarded Goal** - If, when the opposing goalkeeper has been removed from the ice, a player in control of the puck in the neutral or attacking zone is tripped or otherwise fouled with no opposition between him and the opposing goal, thus preventing a reasonable scoring opportunity, the Referee shall immediately stop play and award a goal to the attacking team.



## SECTION 8 – STICK FOULS

### Rule 58 – Butt-ending

- 58.1 **Butt-ending** – The action whereby a player uses the shaft of the stick, above the upper hand, to check an opposing player in any manner or jabs or attempts to jab an opposing player with this part of the stick.
- 58.2 **Double-minor Penalty** - A double-minor penalty will be imposed on a player who attempts to butt-end an opponent.
- 58.3 **Major Penalty** - A major penalty shall be imposed on a player who butt-ends an opponent (see section 58.5).
- 58.4 **Match Penalty** - A match penalty shall be imposed on a player who injures an opponent as a result of a butt-end.
- 58.5 **Game Misconduct Penalty** – When a major penalty is imposed for butt-ending, a game misconduct penalty must also be assessed.
- 58.6 **Fines and Suspensions** - When a major penalty and game misconduct are imposed under this rule, an automatic fine of one hundred dollars (\$100) will be imposed.

If deemed appropriate, supplementary discipline can be applied by the Commissioner at his discretion (refer to Rule 29).

### Rule 59 – Cross-checking

- 59.1 **Cross-checking** - The action of using the shaft of the stick between the two hands to forcefully check an opponent.
- 59.2 **Minor Penalty** - A minor penalty, at the discretion of the Referee based on the severity of the contact, shall be imposed on a player who “cross checks” an opponent.
- 59.3 **Major Penalty** - A major penalty, at the discretion of the Referee based on the severity of the contact, shall be imposed on a player who “cross checks” an opponent (see 59.5).
- 59.4 **Match Penalty** – The Referee, at his discretion, may assess a match penalty if, in his judgment, the player attempted to or deliberately injured his opponent by cross-checking.
- 59.5 **Game Misconduct Penalty** - When a major penalty is assessed for cross-checking, an automatic game misconduct penalty shall be imposed on the offending player.
- 59.6 **Fines and Suspensions** - When a major penalty is imposed under this rule, an automatic fine of one hundred dollars (\$100) shall also be imposed.

If deemed appropriate, supplementary discipline can be applied by the Commissioner at his discretion (refer to Rule 29).

### Rule 60 – High-sticking

- 60.1 **High-sticking** - A “high stick” is one which is carried above the height of the opponent’s shoulders. Players must be in control and responsible for their stick. However, a player is permitted accidental contact on an opponent if the act is committed as a normal windup or follow through of a shooting motion, or accidental contact on the



opposing center who is bent over during the course of a face-off. A wild swing at a bouncing puck would not be considered a normal windup or follow through and any contact to an opponent above the height of the shoulders shall be penalized accordingly.

- 60.2 **Minor Penalty** - Any contact made by a stick on an opponent above the shoulders is prohibited and a minor penalty shall be imposed.
- 60.3 **Double-minor Penalty** - When a player carries or holds any part of his stick above the shoulders of the opponent so that injury results, the Referee shall assess a double-minor penalty for all contact that causes an injury, whether accidental or careless, in the opinion of the Referee.
- 60.4 **Match Penalty** – When, in the opinion of the Referee, a player attempts to or deliberately injures an opponent while carrying or holding any part of his stick above the shoulders of the opponent, the Referee shall assess a match penalty to the offending player.
- 60.5 **Goals** - An apparent goal scored by an attacking player who strikes the puck with his stick carried above the height of the crossbar of the goal frame shall not be allowed. The determining factor is where the puck makes contact with the stick. If the puck makes contact with the stick below the level of the crossbar and enters the goal, this goal shall be allowed.

A goal scored by a defending player who strikes the puck with his stick carried above the height of the crossbar of the goal frame shall be allowed.

- 60.6 **Fines and Suspensions** - There are no specified fines or suspensions for high-sticking, however, supplementary discipline can be applied by the Commissioner at his discretion (refer to Rule 29).

## Hooking

Although hooking can be classified as a stick-related foul, it has been placed in Section 7 – Restraining Fouls as Rule 55 as this tends to be the more prominent application of this rule.

## Rule 61 – Slashing

- 61.1 **Slashing** - Slashing is the act of a player swinging his stick at an opponent, whether contact is made or not. Non-aggressive stick contact to the pant or front of the shin pads, should not be penalized as slashing. Any forceful or powerful chop with the stick on an opponent's body, the opponent's stick, or on or near the opponent's hands that, in the judgment of the Referee, is not an attempt to play the puck, shall be penalized as slashing.
- 61.2 **Minor Penalty** - A minor penalty, at the discretion of the Referee based on the severity of the contact, shall be imposed on a player who slashes an opponent.
- 61.3 **Major Penalty** - A major penalty, at the discretion of the Referee based on the severity of the contact, shall be imposed on a player who slashes an opponent. When injury occurs, a major penalty must be assessed under this rule (see 61.5).



- 61.4 **Match Penalty** – The Referee, at his discretion, may assess a match penalty if, in his judgment, the player attempted to or deliberately injured his opponent by slashing.
- 61.5 **Game Misconduct Penalty** – Whenever a major penalty is assessed for slashing, a game misconduct penalty must also be imposed.
- 61.6 **Penalty Shot** – refer to Rule 57.3 – Tripping.
- 61.7 **Awarded Goal** – refer to Rule 57.4 – Tripping.
- 61.8 **Fines and Suspensions** - There are no specified fines or suspensions for slashing, however, supplementary discipline can be applied by the Commissioner at his discretion (refer to Rule 29).

## **Rule 62 – Spearing**

- 62.1 **Spearing** - Spearing shall mean stabbing an opponent with the point of the stick blade, whether contact is made or not.
- 62.2 **Double-minor Penalty** - A double-minor penalty will be imposed on a player who spears an opponent and does not make contact.
- 62.3 **Major Penalty** - A major penalty shall be imposed on a player who spears an opponent (see 62.5).
- 62.4 **Match Penalty** - A match penalty shall be imposed on a player who injures an opponent as a result of a spear.
- 62.5 **Game Misconduct Penalty** - Whenever a major penalty is assessed for spearing, a game misconduct penalty must also be imposed.
- 62.6 **Fines and Suspensions** - There are no specified fines or suspensions for spearing, however, supplementary discipline can be applied by the Commissioner at his discretion (refer to Rule 29).





## SECTION 9 – OTHER FOULS

### Rule 63 – Delaying the Game

- 63.1 **Delaying the Game** – A player or a team may be penalized when, in the opinion of the Referee, is delaying the game in any manner.
- 63.2 **Minor Penalty** - A minor penalty shall be imposed on any player, including the goalkeeper, who holds, freezes or plays the puck with his stick, skates or body in such a manner as to deliberately cause a stoppage of play. With regard to a goalkeeper, this rule applies outside of his goal crease area.

A minor penalty for delay of game shall be imposed on any player who deliberately shoots or bats (using his hand or his stick) the puck outside the playing area (from anywhere on the ice surface) during the play or after a stoppage of play.

When any player, while in his defending zone, shoots or bats (using his hand or his stick) the puck directly (non-deflected) out of the playing surface, except where there is no glass, a penalty shall be assessed for delaying the game. When the puck is shot into the players' bench, the penalty will not apply. When the puck is shot over the glass 'behind' the players' bench, the penalty will be assessed. When the puck goes out of the playing area directly off a face-off, no penalty shall be assessed.

A minor penalty shall be imposed on any player who delays the game by deliberately displacing a goal post from its normal position. The Referee shall stop play immediately when the offending team gains possession of the puck.

In the event that a goalpost is deliberately displaced by a defending player, prior to the puck crossing the goal line between the normal position of the goalposts, the Referee shall assess a minor penalty for delaying the game if the attacking player has not yet taken the shot or in the act of taking the shot at the open net (see 63.6).

When the net is accidentally displaced by an attacking player, and the defending side is in possession of the puck and moving out of their zone, play shall be permitted to continue until such time as the non-offending team loses possession of the puck. The resulting face-off will take place at a face-off spot in the zone nearest the location where the play was stopped, unless it is in the non-offending team's defending zone, and as such the ensuing face-off would be outside the blue line at one of the face-off spots in the neutral zone. It is possible for a goal to be scored at one end of the rink while the net at the other end has been dislodged, provided that the team being scored upon is the team responsible for dislodging the net at the other end of the rink.

A minor penalty shall be imposed on a player other than the goalkeeper who deliberately falls on or gathers the puck into his body. Any player who drops to his knees to block a shot should not be penalized if the puck is shot under him or becomes lodged in his



clothing or equipment but any use of the hands to make the puck unplayable should be penalized promptly.

If a goalkeeper comes out of his crease to “cut down the angle” on a shot and after making the save covers the puck, this shall be legal. If the goalkeeper races out of his crease in an attempt to beat the attacking player to the puck and instead of playing the puck jumps on the puck causing a stoppage of play, this shall be a minor penalty for delay of game.

A minor penalty shall be imposed on a goalkeeper who, when he is in his own goal crease, deliberately falls on or gathers the puck into his body or who holds or places the puck against any part of the goal in such a manner as to cause a stoppage of play unless he is actually being checked by an opponent.

A goalkeeper shall not play the puck outside of the designated area behind the net. Should the goalkeeper play the puck outside of the designated area behind the goal line, a minor penalty for delay of game shall be imposed. The determining factor shall be the position of the puck. The minor penalty will not be assessed when a goalkeeper plays the puck while maintaining skate contact with his goal crease.

Play shall not be stopped nor the game delayed by reasons of adjustments to clothing, equipment, skates or sticks. For an infringement of this rule, a minor penalty shall be given. No penalty should be assessed when a water bottle is delivered to a goalkeeper, however, this should be conducted during time-outs and if, in the opinion of the Referee, it is being done to intentionally delay the game, a minor penalty may be assessed.

No delay shall be permitted for the repair or adjustment of goalkeeper's equipment. If adjustments are required, the goalkeeper shall leave the ice and his place shall be taken by the substitute goalkeeper immediately. For an infraction of this rule by a goalkeeper, a minor penalty shall be imposed.

- 63.3 **Bench Minor Penalty** - A bench minor penalty shall be imposed upon any Team which, after warning by the Referee to its Captain or Alternate Captain to place the correct number of players on the ice and commence play, fails to comply with the Referee's direction and thereby causes any delay by making additional substitutions (including, but not limited to, continually substituting goalkeepers for the purpose of stalling or delaying the game), by persisting in having its players off-side, or in any other manner.
- 63.4 **Objects Thrown on the Ice** – In the event that objects are thrown on the ice that interfere with the progress of the game, the Referee shall blow the whistle and stop the play and the puck shall be faced-off at a face-off spot in the zone nearest to the spot where play is stopped. When objects are thrown on the ice during a stoppage in play, including after the scoring of a goal, the Referee shall have announced over the public address system that any further occurrences will result in a bench minor penalty being assessed to the home Team. Articles thrown onto the ice following a special



occasion (i.e. hat trick) will not result in a bench minor penalty being assessed. Refer also to Rule 53.6 when spectator interference occurs during a breakaway.

- 63.5 Penalty Shot** - If the goal post is deliberately displaced by a goalkeeper or player during the course of a “breakaway,” a penalty shot will be awarded to the non-offending team, which shot shall be taken by the player last in possession of the puck.

If by reason of insufficient time in the regular playing time or by reason of penalties already imposed, the minor penalty assessed to a player for deliberately displacing his own goal post cannot be served in its entirety within the regular playing time of the game or at any time in overtime, a penalty shot shall be awarded against the offending team.

No defending player, except the goalkeeper, will be permitted to fall on the puck, hold the puck, pick up the puck, or gather the puck into the body or hands when the puck is within the goal crease. For infringement of this rule, play shall immediately be stopped and a penalty shot shall be ordered against the offending team, but no other penalty shall be given. The rule shall be interpreted so that a penalty shot will be awarded only when the puck is in the crease at the instant the offense occurs. However, in cases where the puck is outside the crease, Rule 63 may still apply and a minor penalty may be imposed, even though no penalty shot is awarded. The significant factor when determining whether or not a penalty shot is warranted is the location of the puck at the time it was held, grabbed or gathered into the body. If the puck is in the crease, penalty shot. If the puck is outside the crease and gathered into the body of a player (other than the goalkeeper) who is inside the crease, minor penalty). See also Rule 67 – Handling Puck.

- 63.6 Awarded Goal** - In the event that the goal post is displaced, either deliberately or accidentally, by a defending player, prior to the puck crossing the goal line between the normal position of the goalposts, the Referee may award a goal.

In order to award a goal in this situation, the goal post must have been displaced by the actions a defending player, the puck must have been shot (or the player must be in the act of shooting) at the goal prior to the goal post being displaced, and it must be determined that the puck would have entered the net between the normal position of the goal posts.

When the goal post has been displaced deliberately by the defending team when their goalkeeper has been removed for an extra attacker thereby preventing an impending goal by the attacking team, the Referee shall award a goal to the attacking team.

The goal frame is considered to be displaced if either or both goal pegs are no longer in their respective holes in the ice, or the net has come completely off one or both pegs, prior to or as the puck enters the goal.



**63.7 Infractions** – The following list of infractions shall result in a penalty (minor, bench minor, penalty shot or awarded goal) being imposed by the Referee for delaying the game:

- (i) *Deliberately shooting the puck out of play.*
- (ii) *Deliberately throwing or batting the puck out of play.*
- (iii) *Shooting or batting the puck (with the hand or with the stick) over the glass from the defending zone.*
- (iv) *Deliberately displacing the goal from its normal position (or accidentally by a defending player or goalkeeper in relation to the awarding of a goal).*
- (v) *Refusing to place the correct number of players on the ice.*
- (vi) *Persisting in having players in an off-side position.*
- (vii) *Deliberately falling on the puck.*
- (viii) *Adjustment of clothing or equipment.*

## **Rule 64 – Diving / Embellishment**

**64.1 Diving / Embellishment** – Any player who blatantly dives, embellishes a fall or a reaction, or who feigns an injury shall be penalized with a minor penalty under this rule.

A goalkeeper who deliberately initiates contact with an attacking player other than to establish position in the crease, or who otherwise acts to create the appearance of other than incidental contact with an attacking player, is subject to the assessment of a minor penalty for diving / embellishment.

**64.2 Minor Penalty** - A minor penalty shall be imposed on a player who attempts to draw a penalty by his actions (“diving / embellishment”).

**64.3 Fines and Suspensions** - Regardless if a minor penalty for diving / embellishment is called, Hockey Operations will review game videos and assess fines to players who dive or embellish a fall or a reaction, or who feign injury. See also Rule **29** – Supplementary Discipline. The call on the ice by the Referee is totally independent of supplementary discipline.

The first such incident during the season will result in a warning letter being sent to the player. The second such incident will result in a one thousand dollar (\$1,000) fine. For a third such incident in the season, the player shall be suspended for one game, pending a telephone conversation with the Director of Hockey Operations. For subsequent violations in the same season, the player’s suspension shall double (i.e. first suspension – one game, second suspension – two games, third suspension – four games, etc.) See also Rule **29** – Supplementary Discipline.



## **Rule 65 – Equipment**

- 65.1 **Equipment** – The onus is on the player to maintain his equipment and uniform in playing condition as set forth in these rules.
- 65.2 **Minor Penalty** - All protective equipment, except gloves, headgear and goalkeepers' leg guards must be worn under the uniform. For violation of this rule, after warning by the Referee, a minor penalty shall be imposed. Players violating this rule shall not be permitted to participate in the game until such equipment has been corrected or removed.

Play shall not be stopped nor the game delayed by reasons of adjustments to clothing, equipment, skates or sticks. For an infringement of this rule, a minor penalty shall be given.

No delay shall be permitted for the repair or adjustment of goalkeeper's equipment. If adjustments are required, the goalkeeper shall leave the ice and his place shall be taken by the substitute goalkeeper immediately. For an infraction of this rule by a goalkeeper, a minor penalty shall be imposed.

## **Rule 66 – Forfeit of Game**

- 66.1 **Forfeit of Game** - In the event of failure by a Club to comply with a provision of the League constitution, by-laws, resolutions, rules or regulations affecting the playing of a game, the Referee shall, if so directed by the Commissioner or his designee, refuse to permit the game to proceed until the offending Club comes into compliance with such provision.

Should the offending club persist in its refusal to come into compliance, the Referee shall, with the prior approval of the Commissioner or his designee, declare the game forfeited and the non-offending Club the winner. Should the Referee declare the game forfeited because both Clubs have refused to comply with such a provision, the visiting Club shall be declared the winner.

If the game is declared forfeited prior to its having commenced, the score shall be recorded as 1-0 and no player shall be credited with any personal statistics.

If the game was in progress at the time it is declared forfeited, the score shall be recorded as zero for the loser and 1, or such greater number of goals that had been scored by it, for the winner; however, the players on both Clubs shall be credited with all personal statistics earned up to the time the forfeit was declared.

## **Rule 67 – Handling Puck**

- 67.1 **Handling Puck** - A player shall be permitted to stop or "bat" a puck in the air with his open hand, or push it along the ice with his hand, and the play shall not be stopped unless, in the opinion of the on-ice



officials, he has deliberately directed the puck to a teammate, or has allowed his team to gain an advantage, in any zone other than the defending zone, in which case the play shall be stopped and a face-off conducted (see Rule 79 – Hand Pass). Play will not be stopped for any hand pass by players in their own defending zone.

- 67.2 **Minor Penalty – Player** - A player shall be permitted to catch the puck out of the air but must immediately place it or knock it down to the ice. If he catches it and skates with it, either to avoid a check or to gain a territorial advantage over his opponent, a minor penalty shall be assessed for “closing his hand on the puck”.

A minor penalty shall be imposed on a player who, while play is in progress, picks up the puck off the ice with his hand.

- 67.3 **Minor Penalty – Goalkeeper** - A goalkeeper who holds the puck with his hands for longer than three seconds shall be given a minor penalty unless he is actually being checked by an opponent. The object of this entire rule is to keep the puck in play continuously and any action taken by the goalkeeper which causes an unnecessary stoppage must be penalized without warning.

A goalkeeper shall be assessed a minor penalty when he deliberately holds the puck in any manner which, in the opinion of the Referee, causes an unnecessary stoppage of play.

A goalkeeper shall be assessed a minor penalty when he throws the puck forward towards the opponent’s net. In the case where the puck thrown forward by the goalkeeper being taken by an opponent, the Referee shall allow the resulting play to be completed, and if goal is scored by the non-offending team, it shall be allowed and no penalty given; but if a goal is not scored, play shall be stopped and a minor penalty shall be imposed against the goalkeeper.

A goalkeeper shall be assessed a minor penalty when he deliberately drops the puck into his pads or onto the goal net.

A goalkeeper shall be assessed a minor penalty when he deliberately piles up snow or obstacles at or near his net that, in the opinion of the Referee, would tend to prevent the scoring of a goal.

- 67.4 **Penalty Shot** - If a defending player, except a goalkeeper, while play is in progress, falls on the puck, holds the puck, picks up the puck, or gathers the puck into his body or hands from the ice in the goal crease area, the play shall be stopped immediately and a penalty shot shall be awarded to the non-offending team. See also Rule 63 – Delaying the Game.

- 67.5 **Awarded Goal** – When a goalkeeper, prior to proceeding to his players’ bench to be replaced by an extra attacker, intentionally leaves his stick or other piece of equipment, piles snow or other obstacles at or near his net that, in the opinion of the Referee, would tend to prevent the puck from entering the net, a goal shall be awarded. In order to award a goal in this situation, the goalkeeper must have been replaced for an extra attacker, otherwise a minor penalty shall be assessed.



If a player, when the goalkeeper has been replaced for an extra attacker, falls on the puck, holds the puck, picks up the puck, or gathers the puck into his body or hands from the ice in the goal crease area, the play shall be stopped immediately and goal awarded to the non-offending team.

- 67.6 **Disallowed Goal** - A goal cannot be scored by an attacking player who bats or directs the puck with his hand into the net. A goal cannot be scored by an attacking player who bats or directs the puck and it is deflected into the net off any player, goalkeeper or official. When the puck enters the net on a clear deflection off a glove, the goal shall be allowed.

## **Rule 68 – Illegal Substitution**

- 68.1 **Illegal Substitution** – An illegal substitution shall be deemed to have occurred when a player enters the game illegally from either the players' bench (teammate not within the five (5) foot limit, refer to Rule 74 – Too Many Men on the Ice), from the penalty bench (penalty has not yet expired), when a major penalty is being served and the replacement player does not return to the ice from the penalty bench (see 68.2), or when a player illegally enters the game for the sole purpose of preventing an opposing player from scoring on a breakaway (see 68.3 and 68.4).

When an injured player is penalized and leaves the game, if he returns before the expiration of his penalty, he is not eligible to play. This includes coincidental penalties when his substitute is still in the penalty box awaiting a stoppage in play. The injured player must wait until his substitute has been released from the penalty box before he is eligible to play. See 8.1.

- 68.2 **Bench Minor Penalty** – When a player receives a major penalty and a misconduct or game misconduct penalty at the same time, or when an injured player receives a major penalty and is unable to serve the penalty himself, the penalized team shall place a substitute player on the penalty bench before the major penalty expires and no replacement for the penalized player shall be permitted to enter the game except from the penalty bench. Any violation of this provision shall be treated as an illegal substitution under this rule calling for a bench minor penalty.
- 68.3 **Penalty Shot** – If a player of the attacking side in possession of the puck shall be in such a position as to have no opposition between him and the opposing goalkeeper, and while in such position he shall be interfered with by a player of the opposing side who shall have illegally entered the game, the Referee shall impose a penalty shot against the side to which the offending player belongs.
- 68.4 **Awarded Goal** - If, when the opposing goalkeeper has been removed from the ice, a player of the side attacking the unattended goal is interfered with in the neutral or attacking zone by a player who shall have entered the game illegally, the Referee shall immediately award



a goal to the non-offending team.

- 68.5 **Disallowed Goal** – If a penalized player returns to the ice from the penalty bench before his penalty has expired by his own error or the error of the Penalty Timekeeper, any goal scored by his own team while he (or his substitute) is illegally on the ice shall be disallowed but all penalties imposed on either team shall be served as regular penalties. The penalized player must return to serve his unexpired time (and an additional minor penalty if he left the penalty bench on his own).

If a player shall illegally enter the game from his own players' bench or from any other location in the rink, any goal scored by his own team while he is illegally on the ice shall be disallowed but all penalties imposed on either team shall be served as regular penalties.

- 68.6 **Deliberate Illegal Substitution** – see Rule 74 – Too Many Men on the Ice.

## **Rule 69 – Interference on the Goalkeeper**

- 69.1 **Interference on the Goalkeeper** - This rule is based on the premise that an attacking player's position, whether inside or outside the crease, should not, by itself, determine whether a goal should be allowed or disallowed. In other words, goals scored while attacking players are standing in the crease may, in appropriate circumstances be allowed. Goals should be disallowed only if: (1) an attacking player, either by his positioning or by contact, impairs the goalkeeper's ability to move freely within his crease or defend his goal; or (2) an attacking player initiates intentional or deliberate contact with a goalkeeper, inside or outside of his goal crease. Incidental contact with a goalkeeper will be permitted, and resulting goals allowed, when such contact is initiated outside of the goal crease, provided the attacking player has made a reasonable effort to avoid such contact. The rule will be enforced exclusively in accordance with the on-ice judgement of the Referee(s), and not by means of video replay or review.

For purposes of this rule, "contact," whether incidental or otherwise, shall mean any contact that is made between or among a goalkeeper and attacking player(s), whether by means of a stick or any part of the body.

The overriding rationale of this rule is that a goalkeeper should have the ability to move freely within his goal crease without being hindered by the actions of an attacking player. If an attacking player enters the goal crease and, by his actions, impairs the goalkeeper's ability to defend his goal, and a goal is scored, the goal will be disallowed.

If an attacking player has been pushed, shoved, or fouled by a defending player so as to cause him to come into contact with the goalkeeper, such contact will not be deemed contact initiated by the attacking player for purposes of this rule, provided the attacking player





has made a reasonable effort to avoid such contact.

- 69.2 Penalty** - In all cases in which an attacking player initiates intentional or deliberate contact with a goalkeeper, whether or not the goalkeeper is inside or outside the goal crease, and whether or not a goal is scored, the attacking player will receive a penalty (minor or major, as the Referee deems appropriate). In all cases where the infraction being imposed is to the attacking player for hindering the goalkeeper's ability to move freely in his goal crease, the penalty to be assessed is for goalkeeper interference.

In exercising his judgment, the Referee should give more significant consideration to the degree and nature of the contact with the goalkeeper than to the exact location of the goalkeeper at the time of the contact.

- 69.3 Contact Inside the Goal Crease** - If an attacking player initiates contact with a goalkeeper, incidental or otherwise, while the goalkeeper is in his goal crease, and a goal is scored, the goal will be disallowed.

If a goalkeeper, in the act of establishing his position within his goal crease, initiates contact with an attacking player who is in the goal crease, and this results in an impairment of the goalkeeper's ability to defend his goal, and a goal is scored, the goal will be disallowed.

If, after any contact by a goalkeeper who is attempting to establish position in his goal crease, the attacking player does not immediately vacate his current position in the goal crease (i.e. give ground to the goalkeeper), and a goal is scored, the goal will be disallowed. In all such cases, whether or not a goal is scored, the attacking player will receive a minor penalty for goalkeeper interference.

If an attacking player establishes a significant position within the goal crease, so as to obstruct the goalkeeper's vision and impair his ability to defend his goal, and a goal is scored, the goal will be disallowed.

For this purpose, a player "establishes a significant position within the crease" when, in the Referee's judgment, his body, or a substantial portion thereof, is within the goal crease for more than an instantaneous period of time.

Refer also to Reference Tables – Table 18 – Interference on the Goalkeeper Situations (page 151).

- 69.4 Contact Outside the Goal Crease** - If an attacking player initiates any contact with a goalkeeper, other than incidental contact, while the goalkeeper is outside his goal crease, and a goal is scored, the goal will be disallowed.

A goalkeeper is not "fair game" just because he is outside the goal crease. The appropriate penalty should be assessed in every case where an attacking player makes unnecessary contact with the goalkeeper. However, incidental contact will be permitted when the



goalkeeper is in the act of playing the puck outside his goal crease provided the attacking player has made a reasonable effort to avoid such unnecessary contact.

When a goalkeeper has played the puck outside of his crease and is then prevented from returning to his crease area due to the deliberate actions of an attacking player, such player may be penalized for goalkeeper interference. Similarly, the goalkeeper may be penalized, if by his actions outside of his crease he deliberately interferes with an attacking player who is attempting to play the puck or an opponent.

Refer also to Reference Tables – Table 18 – Interference on the Goalkeeper Situations (page 151).

**69.5 Face-off Location** – Whenever the Referee stops play to disallow a goal as a result of contact with the goalkeeper (incidental or otherwise), the resulting face-off shall take place at the nearest neutral zone face-off spot outside the attacking zone of the offending team.

**69.6 Rebounds and Loose Pucks** - In a rebound situation, or where a goalkeeper and attacking player(s) are simultaneously attempting to play a loose puck, whether inside or outside the crease, incidental contact with the goalkeeper will be permitted, and any goal that is scored as a result thereof will be allowed.

In the event that a goalkeeper has been pushed into the net together with the puck by an attacking player after making a stop, the goal will be disallowed. If applicable, appropriate penalties will be assessed. If, however, in the opinion of the Referee, the attacking player was pushed or otherwise fouled by a defending player causing the goalkeeper to be pushed into the net together with the puck, the goal can be permitted.

In the event that the puck is under a player in or around the crease area (deliberately or otherwise), a goal cannot be scored by pushing this player together with the puck into the goal. If applicable, the appropriate penalties will be assessed, including a penalty shot if deemed to be covered in the crease deliberately (see Rule **63** – Delaying the Game).

**69.7 Fines and Suspensions** - An attacking player who, in the judgment of the Referee, initiates contact with the goalkeeper, whether inside or outside the crease, in a fashion that would otherwise warrant a penalty, will be assessed an appropriate penalty (minor or major and/or game misconduct) and will be subject to additional sanctions as appropriate pursuant to Rule **29** – Supplementary Discipline.

## **Rule 70 – Leaving the Bench**

**70.1 Leaving the Bench** - No player may leave the players' or penalty bench at any time during an altercation or for the purpose of starting an altercation.



- 70.2 Legal Line Change** – A player who has entered the game while play is in progress from his own players' bench or legally from the penalty bench (penalty time has expired) who starts an altercation may be subject to discipline in accordance with Rule **29** – Supplementary Discipline.

A player or players who have entered the game on a legal line change during a stoppage of play, who line up in preparation for the ensuing face-off, and who participate in an altercation shall be penalized under the appropriate rule and will be subject to discipline in accordance with Rule **29** – Supplementary Discipline (a game misconduct is not automatic in this situation unless provided for as a result of his actions in the altercation).

- 70.3 Leaving the Players' Bench** – Players shall not be permitted to come on the ice during a stoppage of play or at the end of the first and second periods for the purpose of warming-up. The Referee will report any violation of this rule to the Commissioner for disciplinary action.

Except at the end of each period or for entering the game legally, no player may, at any time, leave the players' bench. If it is necessary to proceed to the dressing room during the course of the game (and when it is required to proceed by way of the ice to access the dressing room), the player must wait for a stoppage of play and ensure there are not altercations in progress before proceeding.

The player who was the first or second player to leave the players' (or penalty bench) during an altercation or for the purpose of starting an altercation, from either or both teams shall be assessed a game misconduct penalty.

- 70.4 Leaving the Penalty Bench** – Except at the end of each period or on expiration of his penalty, no player may, at any time, leave the penalty bench.

A player serving a penalty on the penalty bench, who is to be changed after the penalty has been served, must proceed at once by way of the ice and be at his own players' bench before any change can be made. For any violation of this rule, a bench minor penalty shall be imposed for too many men on the ice (see Rule **74** – Too Many Men on the Ice).

A penalized player who leaves the penalty bench before his penalty has expired, whether play is in progress or not, shall incur an additional minor penalty after serving his unexpired penalty.

Any player who, having entered the penalty bench, leaves the penalty bench prior to the expiration of his penalty for the purpose of challenging an official's ruling, shall be assessed a game misconduct penalty. He shall also be automatically suspended for the next three (3) regular League and/or playoff games of his Club. This rule does not replace any other more severe penalty that may be imposed for leaving the penalty bench for the purpose of starting or participating in an altercation as outlined in this rule.



Any penalized player leaving the penalty bench during a stoppage of play and during an altercation shall incur a minor penalty plus a game misconduct penalty. The minor penalty plus the unexpired time remaining in his original penalty must be served by a replacement player placed on the penalty bench by the Coach of the offending team.

If a player leaves the penalty bench before his penalty is fully served, the Penalty Timekeeper shall note the time and signal the officials who will stop play when the offending player's team obtains possession of the puck. An additional minor penalty must be served by this player in addition to the time remaining in his original penalty (this unexpired time is calculated from the time he left the penalty bench illegally).

In the case of a player returning to the ice before his time has expired through an error of the Penalty Timekeeper, he is not to serve an additional penalty, but must serve his unexpired time this unexpired time is calculated from the time he left the penalty bench through the error of the Penalty Timekeeper).

At a stoppage of play following the expiration of their penalties, if a player or players exiting the penalty bench get involved in an altercation, those coming from the penalty bench shall be assessed the penalties they incur in the altercation in addition to a game misconduct and a ten (10) game suspension as outlined in **70.10**. Should a player coming from the penalty bench at a stoppage of play get involved with an opponent and the opponent is deemed to be the instigator of the altercation, then the player coming from the penalty bench would not be subject to the game misconduct and ten (10) game suspension.

**70.5 Bench Minor Penalty** – A bench minor penalty shall be imposed on a team whose player(s) leave the players' bench for any purpose other than a change of players and when no altercation is in progress.

If a Coach or non-playing Club personnel gets on the ice (unless directed to do so by an on-ice official, i.e. to attend to an injured player) after the start of a period and before that period is ended, the Referee shall impose a bench minor penalty against the team and report the incident to the Commissioner for disciplinary action.

**70.6 Game Misconduct Penalty** – A game misconduct penalty shall be imposed on the player who was the first or second player to leave the players' or penalty bench during an altercation or for the purpose of starting an altercation, from either or both teams.

Any penalized player leaving the penalty bench during a stoppage of play and during an altercation shall incur a minor penalty plus a game misconduct penalty. The minor penalty plus the unexpired time remaining in his original penalty must be served by a replacement player placed on the penalty bench by the Coach of the offending team.

Any player who has been ordered to the dressing room by the



officials and returns to his bench or to the ice surface for any reason before the appropriate time shall be assessed a game misconduct and shall be suspended automatically without pay for the next ten (10) regular League and/or Play-off games.

Once a player enters the penalty bench, he must not leave until his penalty expires and his team is entitled to an additional player on the ice, or, at the end of a period to proceed to his dressing room, or, when he has received permission from an on-ice official. At any other time, he shall be assessed a game misconduct penalty under this rule.

- 70.7 **Penalty Shot** – If a player of the attacking side in possession of the puck shall be in such a position as to have no opposition between him and the opposing goalkeeper, and while in such position he shall be interfered with by a player of the opposing side who shall have illegally entered the game, the Referee shall impose a penalty shot against the side to which the offending player belongs.
- 70.8 **Awarded Goal** – If, when the opposing goalkeeper has been removed from the ice, a player of the side attacking the unattended goal is interfered with in the neutral or attacking zone by a player who shall have entered the game illegally, the Referee shall immediately award a goal to the non-offending team.
- 70.9 **Disallowed Goal** – If a penalized player returns to the ice from the penalty bench before his penalty has expired by his own error or the error of the Penalty Timekeeper, any goal scored by his own team while he is illegally on the ice shall be disallowed but all penalties imposed on either team shall be served as regular penalties.

If a player shall illegally enter the game from his own players' bench or from the penalty bench, any goal scored by his own team while he is illegally on the ice shall be disallowed but all penalties imposed on either team shall be served as regular penalties.

- 70.10 **Fines and Suspensions** – The first player to leave the players' or penalty bench during an altercation or for the purpose of starting an altercation from either or both teams shall be suspended automatically without pay for the next ten (10) regular League and/or Play-off games of his team.

The second player to leave the players' or penalty bench during an altercation or for the purpose of starting an altercation from either or both teams shall be suspended automatically without pay for the next five (5) regular League and/or Play-off games.

The determination as to which players shall be deemed the first or second players to have left their respective players' or penalty benches shall be made by the Referees in consultation with the Linesmen and off-ice officials. In the event that they are unable to identify the offending players, the matter will be referred to the Commissioner or his designee and such determinations may be made subsequently based on reports and other information including but not limited to television tapes.

Any team that has a player penalized for being the first or second



player to leave the players' or penalty bench during an altercation or for the purpose of starting an altercation, shall be fined ten thousand dollars (\$10,000) for the first instance. This fine shall be increased by five thousand dollars (\$5,000) for each subsequent occurrence over the next following three-year period.

All players as well as the first and second players who leave the bench during an altercation or for the purpose of starting an altercation shall be subject to an automatic fine in the amount equal to the maximum permitted under the collective bargaining agreement.

Any player who leaves the penalty bench during an altercation and is not the first player to do so, shall be suspended automatically without pay for the next five (5) regular League and/or Play-off games.

Any Club executive or non-playing Club personnel not normally on the players' bench, who gets on the ice after the start of a period and before that period is ended, will be automatically fined two hundred dollars (\$200) and the Referee will report the incident to the Commissioner for disciplinary action.

Any player who has been ordered to the dressing room by the officials and returns to his bench or to the ice surface for any reason before the appropriate time shall be assessed a game misconduct and shall be suspended automatically without pay for the next ten (10) regular League and/or Play-off games.

The Coach(es) of the team(s) whose player(s) left the players' bench(es) or penalty bench(es) during an altercation shall be suspended, pending a review by the Commissioner. The Coach(es) also will be fined a maximum of ten thousand dollars (\$10,000).

For all suspensions imposed on players under this rule, the Club of the player or goalkeeper shall pay to the League a sum equal to the pro-rata of that player's salary covered by the suspension. For purposes of computing amounts due for a player's suspension, the player's fixed salary shall be divided by the number of days in the regular season and then, said result shall be multiplied by the number of games suspended.

In addition, any Club that is deemed by the Commissioner to pay or reimburse to the player the amount of the fine or loss of salary assessed under this rule shall be fined automatically one hundred thousand dollars (\$100,000).

In the event that suspensions imposed under this rule cannot be completed in regular League and/or Play-off games in any one season, the remainder of the suspension shall be served the following season.

## **Rule 71 – Premature Substitution**

**71.1 Premature Substitution** - When a goalkeeper leaves his goal area and proceeds to his players' bench for the purpose of substituting another player, the skater cannot enter the playing surface before the



goalkeeper is within five feet (5') of the bench. If the substitution is made prematurely, the official shall stop play immediately unless the non-offending team has possession of the puck -- in which event the stoppage will be delayed until the puck changes possession.

There shall be no time penalty to the team making the premature substitution, but the resulting face-off will take place at the center ice face-off spot when play is stopped beyond the center red line. When play is stopped prior to the center red line, the resulting face-off shall be conducted at the nearest face-off spot in the zone where the play was stopped.

In all other situations not covered in the above, a minor penalty may result for "too many men on the ice" (see Rule 74).

- 71.2 **Announcement** - The Referee shall request that the public address announcer make the following announcement: "Play has been stopped due to premature substitution for the goalkeeper."

## **Rule 72 – Refusing to Play the Puck**

- 72.1 **Refusing or Abstaining from Playing the Puck** - The purpose of this section is to enforce continuous action and both Referees and Linesmen should interpret and apply the rule to produce this result.
- 72.2 **Hand Pass** – When a hand pass has been initiated by one player to a teammate and the teammate elects not to play the puck to avoid the stoppage of play, and the opposing team also abstains from playing the puck (perhaps to allow time to expire on a penalty), the Referee shall stop the play and order the resulting face-off at the nearest face-off location to where the play was stopped for this violation.
- 72.3 **High Stick** – When a player contacts the puck with his stick above the normal height of the shoulders and a teammate elects not to play the puck to avoid the stoppage of play, and the opposing team also abstains from playing the puck (perhaps to allow time to expire on a penalty), the Referee shall stop the play and order the resulting face-off at the face-off spot in the zone to nearest to where the play was stopped for this violation. See also 76.2.
- 72.4 **Icing** – If, in the opinion of the Referee, the defending side intentionally abstains from playing the puck on an icing promptly when they are in a position to do so, he shall stop the play and order the resulting face-off on the adjacent corner face-off spot nearest the goal of the team at fault.
- 72.5 **Penalty** – When the Referee signals the delayed calling of a penalty to one team and a player of that team intentionally abstains from playing the puck in order to allow additional time to expire on the game or penalty time clocks, the Referee shall stop the play and order the resulting face-off at one of the face-off spots in the offending team's defending zone. See Rule 76.2.

**Rule 73 – Refusing to Start Play**

73.1 **Refusing to Start Play** – This rule applies to teams who refuse to play while both teams are on the ice or who withdraws from the ice and refuses to play or who refuses to come onto the ice at the start of the game or at the beginning of any period of the game, when ordered to do so by the Referee.

73.2 **Procedure – Team On Ice** - If, when both teams are on the ice, one team for any reason shall refuse to play when ordered to do so by the Referee, he shall warn the Captain and allow the team so refusing fifteen (15) seconds within which to begin the play or resume play. If at the end of that time, the team shall still refuse to play, the Referee shall impose a bench minor penalty for delay of game on a player of the offending team to be designated by the Coach of that team through the playing Captain. Should there be a repetition of the same incident, the Referee shall notify the Coach that he has been fined the sum of two hundred dollars (\$200). The offending Coach shall be removed from the players' bench and assessed a game misconduct penalty.

Should the offending team still refuse to play, the Referee shall have no alternative but to declare that the game be forfeited to the non-offending Club and the case shall be reported to the Commissioner for further action (see Rule 66 – Forfeit of Game).

**First Violation**

- (i) *Warn the Captain of the offending team and allow 15 seconds within which to resume play.*
- (ii) *If at the end of the 15 seconds the team still refuses to resume play, assess a bench minor penalty to the offending team for delay of game.*

**Second Violation**

- (i) *Warn the Captain of the offending team and allow 15 seconds within which to resume play.*
- (ii) *If at the end of the 15 seconds the team still refuses to resume play, assess a bench minor penalty to the offending team for delay of game.*
- (iii) *Referee is to notify the Coach of the offending team that he has been fined the sum of two hundred dollars (\$200) and the Coach is to be assessed a game misconduct penalty.*
- (iv) *If the team still refuses to play, the Referee shall declare the game be forfeited to the non-offending club (see Rule 66 – Forfeit of Game).*

73.3 **Procedure – Team Off Ice** - If a team, when ordered to do so by the Referee through its Club Executive, Manager or Coach, fails to go on the ice and start play within five (5) minutes, the Club Executive, Manager or Coach shall be fined five hundred dollars (\$500), the game shall be forfeited and the case shall be reported to the Commissioner for further action (see Rule 66 – Forfeit of Game).





- (i) *Once it is apparent to the Referee that the team is refusing to come onto the ice and begin play, a bench minor penalty is to be assessed to the offending team for delay of game.*
- (ii) *Five (5) minutes will be provided for the offending team to return to the ice and begin play.*
- (iii) *After the five (5) minutes has elapsed and the offending team still has not returned to the ice to resume play, the game shall be forfeited. The Commissioner of the League shall issue instructions pertaining to records, etc., of a forfeited game (see Rule 66 – Forfeit of Game).*
- (iv) *Once the Club Executive, Manager or Coach has been notified of the five (5) minute warning, and the team returns to the ice to resume play within that time frame, a bench minor penalty for delay of game must be assessed to the offending team.*
- (v) *A fine of five hundred dollars (\$500) shall be applied to the Coach, Manager, or Club Executive responsible for the delay.*

## **Rule 74 – Too Many Men on the Ice**

**74.1 Too Many Men on the Ice** - Players may be changed at any time during the play from the players' bench provided that the player or players leaving the ice shall be within five feet (5') of his players' bench and out of the play before the change is made. Refer also to Rule 71 – Premature Substitution. At the discretion of the on-ice officials, should a substituting player come onto the ice before his teammate is within the five foot (5') limit of the players' bench (and therefore clearly causing his team to have too many players on the ice), then a bench minor penalty may be assessed.

When a player is retiring from the ice surface and is within the five foot (5') limit of his players' bench, and his substitute is on the ice, then the retiring player shall be considered off the ice for the purpose of Rule 70 – Leaving Bench.

If in the course of making a substitution, either the player entering the game or the player retiring from the ice surface plays the puck with his stick, skates or hands or who checks or makes any physical contact with an opposing player while either the player entering the game or the retiring player is actually on the ice, then the infraction of "too many men on the ice" will be called.

If in the course of a substitution either the player(s) entering the play or the player(s) retiring is struck by the puck accidentally, the play will not be stopped and no penalty will be called.

During the play, the player retiring from the ice must do so at the players' bench and not through any other exit leading from the rink. This is not a legal player change and therefore when a violation occurs, a bench minor penalty shall be imposed.

A player coming onto the ice as a substitute player is considered on the ice once both of his skates are on the ice. If he plays the puck or interferes with an opponent while still on the players' bench, he shall be penalized under Rule 56 – Interference.



- 74.2 **Bench Minor Penalty** – A bench minor penalty for too many men on the ice shall be assessed for a violation of this rule. This penalty can be assessed by the Referees or the Linesmen. Should a goal be scored by the offending team prior to the Referee or Linesman blowing his whistle to assess the bench minor penalty, the goal shall be disallowed and the penalty assessed for too many men on the ice.
- 74.3 **Penalty Bench** - A player serving a penalty on the penalty bench, who is to be changed after the penalty has been served, must proceed at once by way of the ice and be within five feet (5') of his own players' bench before any change can be made. For any violation of this rule, a bench minor penalty shall be imposed for too many men on the ice.
- 74.4 **Deliberate Illegal Substitution** - If by reason of insufficient playing time remaining, or by reason of penalties already imposed, a bench minor penalty is imposed for deliberate illegal substitution (too many men on the ice) which cannot be served in its entirety within the legal playing time, or at any time in overtime, a penalty shot shall be awarded against the offending team.
- 74.5 **Goalkeeper in Regular Season Overtime** - Once the goalkeeper has been removed for an extra attacker in overtime during the Regular season, he must wait for the next stoppage of play before returning to his position. Any attempt by the goalkeeper to return to his position prior to the next stoppage of play ("on the fly") shall be deemed to be an illegal substitution and a bench minor penalty shall be assessed for having an ineligible player would apply.

## **Rule 75 – Unsportsmanlike Conduct**

- 75.1 **Unsportsmanlike Conduct** – Players and non-playing Club personnel are responsible for their conduct at all times and must endeavor to prevent disorderly conduct before, during or after the game, on or off the ice and any place in the rink. The Referees may assess penalties to any of the above team personnel for failure to do so.

NOTE: When such conduct is directed at an official, Rule **40** – Abuse of Officials shall be applied.

- 75.2 **Minor Penalty** - A minor penalty for unsportsmanlike conduct shall be assessed under this rule for the following infractions:
- (i) *Any identifiable player who uses obscene, profane or abusive language or gestures directed at any person.*
  - (ii) *Any player who is guilty of unsportsmanlike conduct including, but not limited to hair-pulling, biting, grabbing hold of a face mask, etc. If warranted, and specifically when injury results, the referee may apply Rule **21** – Match Penalties.*
  - (iii) *Any player who throws any object onto the ice from the players' or penalty bench (or from any other off-ice location).*



- (iv) *When a player, including a goalkeeper, is penalized for being the instigator of an altercation and who is wearing a face shield.*
- (v) *A player who deliberately removes his jersey prior to participating in an altercation or who is clearly wearing a jersey that has been modified and does not conform to Rule 9 – Uniforms, shall be assessed a minor penalty for unsportsmanlike conduct and a game misconduct. If the altercation never materializes, the player would receive a minor penalty for unsportsmanlike conduct and a ten-minute misconduct for deliberately removing his jersey.*

If a penalized player is assessed an additional unsportsmanlike conduct penalty either before or after he begins serving his original penalty(ies), the additional minor penalty is added to his unexpired time and served consecutively.

**75.3 Bench Minor Penalty** - A bench minor penalty for unsportsmanlike conduct shall be assessed under this rule for the following infractions:

- (i) *When a player, Coach or non-playing Club personnel throws any object onto the ice from the players' or penalty bench (or from any other off-ice location) during the progress of the game or during a stoppage of play.*
- (ii) *Any unidentifiable player or any Coach or non-playing Club personnel uses obscene, profane or abusive language or gesture directed towards any person.*
- (iii) *Whenever Coaches and/or non-playing Club personnel uses obscene or profane language or gestures anywhere in the rink.*

**75.4 Misconduct Penalty** - Misconduct penalties shall be assessed under this rule for the following infractions:

- (i) *Any player who persists in using obscene, profane or abusive language directed towards any person after being assessed a minor or bench minor penalty under this Rule.*
- (ii) *Any player who deliberately throws any equipment out of the playing area. At the discretion of the Referee, a game misconduct may be imposed.*
- (iii) *Any player who persists in any course of conduct (including threatening or abusive language or gestures or similar actions) designed to incite an opponent into incurring a penalty.*
- (iv) *When a penalized player challenges or disputes the ruling of an official after he has already entered the penalty bench and play has resumed.*
- (v) *In general, participants displaying this type of behavior are assessed a minor penalty, then a misconduct penalty and then a game misconduct penalty if they persist.*

**75.5 Game Misconduct Penalty** – Game misconduct penalties shall be assessed under this rule for the following infractions:

- (i) *If a player persists in any course of conduct for which he was previously assessed a misconduct penalty.*
- (ii) *Any player who uses obscene gestures on the ice or anywhere in the rink before, during or after the game. The Referee shall report the*



## SECTION 9 – OTHER FOULS



*circumstances to the Commissioner of the League for further disciplinary action.*

- (iii) Coaches and non-playing Club personnel who have previously been assessed a bench minor penalty for the use obscene or profane language or gestures anywhere in the rink. A confidential report to the Commissioner shall be completed and filed with the League for possible further disciplinary action.*
- (iv) Any player who attempts to or deliberately injures a Manager, Coach or other non-playing Club personnel in any manner. Details of such incident must be reported immediately to the Commissioner and may be subject to additional sanctions as per Rule 29 – Supplementary Discipline.*
- (v) Any player or non-playing Club personnel who directs obscene, profane or abusive language or gestures to any person after the expiration of the game. This action may occur on or off the ice.*
- (vi) In general, participants displaying this type of behavior are assessed a minor penalty, then a misconduct penalty and then a game misconduct penalty if they persist.*

Any player or non-playing Club personnel penalized under this section may be subject to supplemental discipline under Rule 29.

**75.6 Reports** - It is the responsibility of all game officials and all Club officials to send a confidential report to the Commissioner setting out the full details concerning the use of obscene gestures or language by any player, Coach or other team official. The Commissioner shall take such further disciplinary action as he shall deem appropriate.



## SECTION 10 – GAME FLOW

### Rule 76 – Face-offs

**76.1 Face-off** – The action of the Referee or Linesman in dropping the puck between the sticks of two opposing players to start or resume play. A face-off begins when the official indicates the location of the face-off and the officials and players take their appropriate positions. The face-off ends when the puck has been legally dropped.

A goalkeeper may not participate in a face-off.

**76.2 Face-off Locations** – All face-offs must be conducted on one of the nine (9) face-off spots located on the rink.

When a stoppage of play has been caused by any player of the attacking side in the attacking zone, the ensuing face-off shall be made in the neutral zone on the nearest face-off spot. If two rule violations are the reason for the stoppage of play (ie. high-sticking the puck and intentional off-side), the ensuing face-off location shall be determined as the spot that provides the least amount of territorial advantage to the offending team.

When the play is stopped for any reason not specifically attributable to either team while the puck is in the neutral zone, the ensuing face-off shall be conducted at the nearest face-off spot outside the blue line whenever possible. When it is unclear as to which of the four face-off spots is the nearest, the spot that gives the home team the greatest territorial advantage in the neutral zone will be selected for the ensuing face-off.

When players are penalized at a stoppage of play so as to result in penalties being placed on the penalty time clock to one team, the ensuing face-off shall be conducted at one of the two face-off spots in the offending team's end zone. There are only four exceptions to this application:

- (i) *when a penalty is assessed after the scoring of a goal - face-off at center ice;*
- (ii) *when a penalty is assessed at the end (or start) of a period - face-off at center ice;*
- (iii) *when the defending team is penalized and the attacking players enter the attacking zone beyond the outer edge of the end zone face-off circle - face-off in the neutral zone (see paragraph 10 of this section);*
- (iv) *when the team not being penalized ices the puck - face-off in the neutral zone outside the blue line of the team icing the puck.*

When an infringement of a rule has been committed by players of both sides in the play resulting in the stoppage, the ensuing face-off will be made at the nearest face-off spot in that zone.

When stoppage occurs between the end face-off spots and near end of the rink, the puck shall be faced-off at the end face-off spot on the side where the stoppage occurs unless otherwise expressly provided by these rules.



No face-off shall be made within fifteen feet (15') of the goal or side boards nor anywhere other than at a face-off spot.

When a goal is illegally scored as a result of a puck being deflected directly off an official anywhere in the defending zone, the resulting face-off shall be made at the end face-off spot in the defending zone.

When the game is stopped for any reason not specifically covered in the official rules, the puck must be faced-off at a face-off spot in the zone nearest to where it was last played.

Following a stoppage of play, should one or both defensemen who are the point players or any player coming from the bench of the attacking team, enter into the attacking zone beyond the outer edge of the end zone face-off circle during an altercation, gathering or "scrum," the ensuing face-off shall take place in the neutral zone near the blue line of the defending team. This rule also applies when an icing, an intentional off-side, or a high-sticking the puck violation (by the team of greater numerical strength of its opponent) has occurred, and the ensuing face-off is to be in the offending team's defending zone. Should any of the non-offending players enter into the attacking zone beyond the outer edge of the end zone face-off circle during an altercation, gathering or "scrum," the ensuing face-off shall take place in the neutral zone near the blue line of the defending team.

For a violation of Rule 71 – Premature Substitution, the resulting face-off will take place at the center ice face-off spot when play is stopped beyond the center red line. When play is stopped prior to the center red line, the resulting face-off shall be conducted at the nearest face-off spot in the zone where the play was stopped.

When play is stopped for an injured player, the ensuing face-off shall be conducted at the face-off spot in the zone nearest the location of the puck when the play was stopped. When the injured player's team has possession of the puck in the attacking zone, the face-off shall be conducted at one of the face-off spots outside the blue line in the neutral zone. When the injured player is in his defending zone and the attacking team is in possession of the puck in the attacking zone, the face-off shall be conducted at one of the defending team's end-zone face-off spots.

**76.3 Procedure** – As soon as the line change procedure has been completed by the Referee and he lowers his hand to indicate no further changes, the Linesman conducting the face-off shall blow his whistle. This will signal to both teams that they have no more than five (5) seconds to line up for the ensuing face-off. At the end of the five (5) seconds (or sooner if both centers are ready), the Linesman will conduct a proper face-off. If, however:

- (i) One or both centers are not positioned for the face-off,
- (ii) One or both centers refrain from placing their stick on the ice,
- (iii) Any player has encroached into the face-off circle,
- (iv) Any player makes physical contact with an opponent, or



(v) *Any player who lines up for the face-off in an off-side position,*

the Linesman shall have the offending center(s) replaced immediately prior to dropping the puck.

In the last two (2) minutes of regulation time or any time in overtime, the Linesman will still blow his whistle to initiate the face-off, but the five (5) second time limit will not be enforced. However, players must abide by the verbal directions given by the Linesman in his attempt to conduct a fast and fair face-off.

- 76.4 Procedure – Centers** – The puck shall be faced-off by the Referee or the Linesman dropping the puck on the ice between the sticks of the players facing-off. Players facing-off will stand squarely facing their opponent's end of the rink approximately one stick length apart with the blade of their sticks on the ice.

When the face-off takes place in any of the end face-off circles, the players taking part shall take their position so that they will stand squarely facing their opponent's end of the rink, and clear of the ice markings. The sticks of both players facing-off shall have the blade on the ice, within the designated white area. The visiting player shall place his stick within the designated white area first followed immediately by the home player.

If a player facing-off fails to take his proper position immediately when directed by the official, the official may order him replaced for that face-off by any teammate then on the ice.

If a center is not at the designated face-off area once the five (5) second time limit has elapsed, the Linesman will drop the puck immediately. If the center is back from the face-off spot, is "quarterbacking" or refuses to come into the face-off area when instructed to do so by the Linesman, or the center is simply slow getting to the face-off spot when the five (5) seconds has elapsed, the puck shall be dropped. If the center attempts to arrive at the face-off spot just as the five seconds elapses in an attempt to gain an advantage to win the face-off, he is to be removed from the face-off and replaced, resulting in a face-off violation.

If a player is ejected from the face-off, his replacement must come into position quickly or risk having the puck dropped by the Linesman without the player being set, or ejected from the face-off by the Linesman resulting in a bench minor penalty for delay of game for a second face-off violation during the same face-off.

- 76.5 Procedure – Other Players** – No other player shall be allowed to enter the face-off circle or come within fifteen feet (15') of the players facing-off. All players must stand on-side on all face-offs.

During end-zone face-offs, all other players on the ice must position their bodies on their own side of the restraining lines marked on the outer edge of the face-off circles.

If a player other than the player taking the face-off moves into the face-off circle prior to the dropping of the puck, then the offending team's player taking the face-off shall be ejected from the face-off



circle. This shall be considered a face-off violation.

Players on the attacking team (exclusive of the center) must establish their position first and then the defending team may counter and hold its position until the puck is dropped. A violation of this procedure shall be treated as face-off encroachment and the Linesman shall order the center of the offending team replaced. Should an attacking player attempt to establish a new position prior to the face-off, and the defending center steps back from the face-off spot in order to reposition his teammates, the face-off violation shall be charged to the attacking team as they must establish their position first.

**76.6 Violations** – If a center should move prematurely prior to the face-off, or if the Referee or Linesman shall have dropped the puck unfairly, the face-off shall be considered a face-off violation and it must be conducted again.

When a least two face-off violations have been committed by the same team during the same face-off, this team shall be penalized with a bench minor penalty to the offending team. This penalty shall be announced as a “Bench Minor Penalty for Delay of Game – Face-off Violation.”

Face-off violations shall be summarized as follows (any of the four on-ice officials may identify a face-off violation):

- (i) *Encroachment by any player other than the center into the face-off area prior to the puck being dropped. Players on the perimeter of the face-off circle must keep both skates outside the face-off circle (skate contact with the line is permitted). If a player's skate crosses the line into the face-off circle prior to the drop of the puck, this shall be deemed as a face-off violation. A player's stick may be inside the face-off circle provided there is no physical contact with his opponent or his opponent's stick.*
- (ii) *Encroachment by any player into the area between the hash marks on the outer edges of the face-off circle prior to the puck being dropped. Players must also ensure that both of their skates do not cross their respective hash marks. Contact with the line with their skate is permitted. If a player's skate crosses the line into the area between the hash marks prior to the drop of the puck, this shall be deemed as a face-off violation. A player's stick may be inside the area between the hash marks provided there is no physical contact with his opponent or his opponent's stick.*
- (iii) *Any physical contact with an opponent prior to the puck being dropped.*
- (iv) *Failure by either center taking the face-off to properly position himself behind the restraining lines or place his stick on the ice (as outlined in Rule 76.4). "Properly position himself behind the restraining lines" shall mean that the center must place his feet on either side of the restraining lines that are parallel to the side boards (contact with the lines is permissible), and the toe of the blade of his skates must not cross over the restraining lines that are perpendicular to the side boards as he approaches the face-off spot.*

*The blade of the stick must then be placed on the ice (at least the*





*toe of the blade of the stick) in the designated white area of the face-off spot and must remain there until the puck is dropped.*

*Failure to comply with this positioning and face-off procedure will result in a face-off violation.*

Whenever a team has committed two face-off violations during the same face-off, the Referee shall immediately assess the offending team a bench minor penalty for delay of game. This penalty shall be announced as a “Bench Minor Penalty for Delay of Game – Face-off Violation.”

Players who are late to the face-off location and therefore in an off-side position for the ensuing face-off will be warned once in the game by the Referee. This warning will also be given to the offending team’s Coach. In this situation, the offending team’s center is not ejected from the face-off. Any subsequent violation shall result in a bench minor penalty for delay of game being assessed to the offending team. This penalty shall be announced as a “Bench Minor Penalty for Delay of Game – Slow Proceeding to Face-off Location.”

In the conduct of any face-off at any of the nine (9) face-off spots on the playing surface, no player facing-off shall make any physical contact with his opponent’s body by means of his own body or by his stick except in the course of playing the puck after the face-off has been completed.

For violation of this rule, the Referee may, at his discretion impose a minor penalty or penalties on the player(s) whose action(s) caused the physical contact. Nonetheless, this physical contact prior to the dropping of the puck shall be deemed as a face-off violation and the Linesman shall order the center of the offending team replaced.

Face-off encroachment may be applied during face-offs at any of the nine (9) face-off spots on the playing surface. However, since no such lines are painted on the ice at the four (4) face-off spots adjacent to the blue lines, Linesmen shall use their judgment as to whether or not a violation has occurred. All players, other than the centers, shall be uniformly back from the face-off location similar to being outside the face-off circle for face-offs in the end zones.

- 76.7 Line Changes** – No substitution of players shall be permitted until the face-off has been completed and play has resumed except when a penalty is imposed which affects the on-ice strength of either team.

Should an on-ice official notice that the defending team has not placed enough players on the ice for the ensuing face-off, the Referee in the neutral zone shall be notified and he will instruct the offending team to place another player(s) on the ice. If, in the opinion of the Referee that this is being done as a stalling tactic, he will issue a warning to the offending team’s Coach and any subsequent violations shall result in the assessment of a bench minor penalty for delay of game.

Should an on-ice official notice that the attacking team has not placed enough players on the ice for the ensuing face-off, the



Linesman will proceed with conducting the face-off in the normal manner. The attacking team must ensure they put the appropriate number of players on the ice at all times.

- 76.8 **Verification of Time** - Any loss of time on the game or penalty clocks due to a false face-off or face-off violation must be replaced. The Video Goal Judge may be consulted to ensure the time is accurately replaced.

The whistle will not be blown by the official to start play. Playing time will commence from the instant the puck is faced-off and will stop when the whistle is blown or a goal is scored.

## **Rule 77 – Game and Intermission Timing**

- 77.1 **Game Timing** – The time allowed for a game shall be three (3) twenty-minute periods of actual play with a rest intermission between periods.
- 77.2 **Intermission Timing** – Play shall be resumed promptly following each intermission upon the expiration of seventeen (17) minutes or a length of time designated by the League from the completion of play in the preceding period. Timing of the intermission commences immediately upon the conclusion of the period. (See Rule 35 – Game Timekeeper.) Preliminary warnings shall be given by the Game Timekeeper to the officials and to both teams five (5) minutes and two (2) minutes prior to the resumption of play in each period to enable the teams to start play promptly.

For the purpose of keeping the spectators informed as to the time remaining during intermissions, the Game Timekeeper will use the electronic clock to record length of intermissions.

- 77.3 **Delays** - If any unusual delay occurs within five (5) minutes of the end of the first or second periods, the Referee may order the next regular intermission to be taken immediately. The balance of the period will be completed on the resumption of play with the teams defending the same goals after which the teams will change ends and resume play of the ensuing period without delay.

If a delay takes place with more than five (5) minutes remaining in the first or second period, the Referee will order the next regular intermission to be taken immediately only when requested to do so by the home Club.

## **Rule 78 – Goals**

- 78.1 **Goals and Assists** - It is the responsibility of the Official Scorer to award goals and assists, and his decision in this respect is final, notwithstanding the report of the Referee or any other game official. The use of video replay to verify the proper awarding of a goal or an assist is essential. Such awards shall be made or withheld strictly in accordance with the provisions of this rule. Therefore, it is essential



that the Official Scorer be thoroughly familiar with every aspect of this rule; be alert to observe all actions which could affect the awarding of a goal or assist; and, above all, give or withhold awards with absolute impartiality.

In case of an obvious error in awarding a goal or an assist that has been announced, it should be corrected promptly, but changes should not be made in the official scoring summary after the Referee has signed the game report (except by the League's Chief Statistician).

The team scoring the greatest number of goals during the three (3) twenty-minute periods shall be the winner and shall be credited with two points in the League standings. In the event a winner during the regular season is determined in the overtime period or the shootout, the winning team shall be credited with two points in the League standings and the losing team will be credited with one point in the League standings.

- 78.2 **Crediting Goals** - A "goal" shall be credited in the scoring records to a player who shall have propelled the puck into the opponent's goal. Each "goal" shall count one point in the player's record. Only one point can be credited to any one player on a goal.
- 78.3 **Crediting Assists** - When a player scores a goal, an "assist" shall be credited to the player or players taking part in the play immediately preceding the goal, but no more than two assists can be given on any goal. Each "assist" shall count one point in the player's record. Only one point can be credited to any one player on a goal.
- 78.4 **Scoring a Goal** - A goal shall be scored when the puck shall have been put between the goal posts by the stick of a player of the attacking side, from in front and below the crossbar, and entirely across a red line the width of the diameter of the goal posts drawn on the ice from one goal post to the other with the goal frame in its proper position. The goal frame shall be considered in its proper position when at least a portion of the flexible peg(s) are still inside both the goal post and the hole in the ice. The flexible pegs could be bent, but as long as at least a portion of the flexible peg(s) are still in the hole in the ice and the goal post, the goal frame shall be deemed to be in its proper position. The goal frame could be raised somewhat on one post (or both), but as long as the flexible pegs are still in contact with the holes in the ice and the goal posts, the goal frame shall not be deemed to be displaced.

A goal shall be scored if the puck is put into the goal in any way by a player of the defending side. The player of the attacking side who last touched the puck shall be credited with the goal but no assist shall be awarded.

If an attacking player has the puck deflect into the net, off his skate or body, in any manner, the goal shall be allowed. The player who deflected the puck shall be credited with the goal.

Should a player legally propel a puck into the goal crease of the opponent Club and the puck should become loose and available to



another player of the attacking side, a goal scored on the play shall be legal.

**78.5 Disallowed Goals** – Apparent goals shall be disallowed by the Referee and the appropriate announcement made by the Public Address Announcer for the following reasons:

- (i) *When the puck has been directed, batted or thrown into the net by an attacking player other than with a stick.*
- (ii) *When the puck has been kicked using a distinct kicking motion.*
- (iii) *When the puck has deflected directly into the net off an official.*
- (iv) *When a goal has been scored and an ineligible player is on the ice.*
- (v) *When an attacking player has interfered with a goalkeeper in his goal crease.*
- (vi) *When the puck has entered the net after making contact with an attacking player's stick that is above the height of the crossbar. Where the puck makes contact with the stick is the determining factor. See 39.4(vi).*
- (vii) *When video review confirms the scoring of a goal at one end of the ice, any goal scored at the other end on the same play must be disallowed.*
- (viii) *When a Linesman reports a double-minor penalty for high-sticking, a major penalty or a match penalty to the Referee following the scoring of a goal by the offending team, the goal must be disallowed and the appropriate penalty assessed.*
- (ix) *When a goalkeeper has been pushed into the net together with the puck after making a save. See also 69.6.*
- (x) *When the net becomes displaced accidentally. The goal frame is considered to be displaced if either or both goal pegs are no longer in their respective holes in the ice, or the net has come completely off one or both pegs, prior to or as the puck enters the goal.*
- (xi) *During the delayed calling of a penalty, the offending team cannot score unless the non-offending team shoots the puck into their own net. This shall mean that a deflection off an offending player or any physical action by an offending player that may cause the puck to enter the non-offending team's goal, shall not be considered a legal goal. Play shall be stopped before the puck enters the net (whenever possible) and the signaled penalty assessed to the offending team.*
- (xii) *When the Referee deems the play has been stopped, even if he had not physically had the opportunity to stop play by blowing his whistle.*
- (xiii) *Any goal scored, other than as covered by the official rules, shall not be allowed.*

**78.6 Video Review** – Any potential goal requiring video review must be reviewed prior to or during the next stoppage of play. No goal may be awarded (or disallowed) as a result of video review once the puck has been dropped and play has resumed. See Rule 39.

When a team scores an apparent goal that is not seen by the on-ice officials and play continues, the play shall be reviewed by the Video Goal Judge at the next stoppage of play. If the goal is confirmed



by video review, the clock (including penalty time clocks, if applicable) is re-set to the time the goal was scored. If the goal is not confirmed by video review, no adjustment is required to the clock time.

Only one goal can be awarded at any stoppage of play. If the apparent goal was scored by Team A, and is subsequently confirmed as a goal by the Video Goal Judge, any goal scored by Team B during the period of time between the apparent goal by Team A and the stoppage of play (Team B's goal), the Team B goal would not be awarded. However, if the apparent goal by Team A is deemed to have entered the goal, albeit illegally (i.e. distinct kicking motion), the goal shall be disallowed by the Video Goal Judge and since the play should have stopped for this disallowed goal, no goal can be awarded to Team B on the same play. The clock (including penalty time clocks, if applicable) must be re-set to the time of the disallowed Team A goal and play resumed.

Any penalties signaled during the period of time between the apparent goal and the next stoppage of play shall be assessed in the normal manner, except when a minor penalty is to be assessed to the team scored upon, and is therefore nullified by the scoring of the goal. Refer to Rules **16.2** and **18.2**. If an infraction happens after the first stoppage of play following an apparent goal (infraction after the whistle) by either team, it is assessed and served in the normal manner regardless as to the decision rendered by the Video Goal Judge.

## **Rule 79 – Hand Pass**

**79.1 Hand Pass** - A player shall be permitted to stop or “bat” a puck in the air with his open hand, or push it along the ice with his hand, and the play shall not be stopped unless, in the opinion of the on-ice officials, he has directed the puck to a teammate, or has allowed his team to gain an advantage, and subsequently possession and control of the puck is obtained by a player of the offending team, either directly or deflected off any player or official.

A player shall be permitted to catch the puck out of the air but must immediately place it or knock it down to the ice. If he catches it and skates with it, either to avoid a check or to gain a territorial advantage over his opponent, a minor penalty shall be assessed for “closing his hand on the puck” under Rule **67** – Handling Puck.

**79.2 Defending Zone** - Play will not be stopped for any hand pass by players in their own defending zone. A hand pass in the defending zone is considered to have occurred when both the player making the pass and the player receiving the pass have both of their skates inside their defending zone.

**79.3 Face-Off Location** – When a hand pass violation has occurred, the ensuing face-off shall take place at the nearest face-off spot in the zone where the offense occurred, unless the offending team gains a territorial advantage, then the face-off shall be at the nearest face-off



spot in the zone where the stoppage of play occurred, unless otherwise covered in the rules. When a hand pass violation occurs by a team in their attacking zone, the ensuing face-off shall be conducted at one of the face-off spots outside the defending team's blue line in the neutral zone.

## **Rule 80 – High-sticking the Puck**

**80.1 High-sticking the Puck** – Batting the puck above the normal height of the shoulders with a stick is prohibited. When a puck is struck with a high stick and subsequently comes into the possession and control of a player from the offending team (including the player who made contact with the puck), either directly or deflected off any player or official, there shall be a whistle.

When a puck has been contacted by a high stick, the play shall be permitted to continue, provided that:

- (i) *the puck has been batted to an opponent (when a player bats the puck to an opponent, the Referee shall give the “washout” signal immediately. Otherwise, he will stop the play).*
- (ii) *a player of the defending side shall bat the puck into his own goal in which case the goal shall be allowed.*

Cradling the puck on the blade of the stick (like lacrosse) above the normal height of the shoulders shall be prohibited and a stoppage of play shall result. If this is done by a player on a penalty shot or shootout attempt, the shot shall be stopped immediately and considered complete.

**80.2 Face-Off Location** - When the play is stopped for the high-sticking the puck violation, the ensuing face-off must take place at the spot that provides the least amount of territorial advantage to the team striking the puck, either where the puck was contacted illegally, or where it was last played by the offending team. If the attacking team is at fault and the play is stopped while the puck is in the attacking zone, the ensuing face-off must be moved to the nearest face-off spot in the neutral zone (except when **80.4** is applicable).

**80.3 Disallowed Goal** – When an attacking player causes the puck to enter the opponent's goal by contacting the puck above the height of the crossbar, either directly or deflected off any player or official, the goal shall not be allowed. The determining factor is where the puck makes contact with the stick. If the puck makes contact with the stick below the level of the crossbar and enters the goal, this goal shall be allowed.

A goal scored as a result of a defending player striking the puck with his stick carried above the height of the crossbar of the goal frame into his own goal shall be allowed.

**80.4 Numerical Advantage** - When either team is below the numerical strength (short-handed) of its opponent and a player of the team of greater numerical strength (power-play) causes a stoppage of play by



striking the puck with his stick above the height of his shoulder, the resulting face-off shall be made at one of the end zone face-off spots adjacent to the goal of the team causing the stoppage. The numerical strength is determined at the time the play is stopped (not necessarily when the puck was struck with the high stick).

Should a player of the team of greater numerical strength (power-play) cause a stoppage of play by striking the puck with his stick above the height of his shoulder, and in so doing causes the puck to go out of play, the resulting face-off shall still be made at one of the end zone face-off spots adjacent to the goal of the team causing the stoppage.

Should a player of the team of greater numerical strength (power-play) cause a stoppage of play by striking the puck with his stick above the height of the crossbar, and in so doing causes the puck to enter the goal, the goal shall be disallowed and the resulting face-off shall still be made at one of the end zone face-off spots adjacent to the goal of the team causing the stoppage.

## **Rule 81 – Icing**

**81.1 Icing** – For the purpose of this rule, the center red line will divide the ice into halves. Should any player of a team, equal or superior in numerical strength (power-play) to the opposing team, shoot, bat or deflect the puck from his own half of the ice beyond the goal line of the opposing team, play shall be stopped. For the purpose of deflected pucks, this only applies when the puck was originally propelled down the ice by the offending team.

For the purpose of this rule, the point of last contact with the puck by the team in possession shall be used to determine whether icing has occurred or not. As such, the team in possession must “gain the line” in order for the icing to be nullified. “Gaining the line” shall mean that the puck, while on the player’s stick (not the player’s skate) must make contact with the center red line in order to nullify a potential icing.

For the purpose of interpretation of the rule, “icing the puck” is completed the instant the puck is touched first by a defending player (other than the goalkeeper) after it has crossed the goal line and if in the action of so touching the puck, it is knocked or deflected into the net, it is no goal.

Any contact between opposing players while pursuing the puck on an icing must be for the sole purpose of playing the puck and not for eliminating the opponent from playing the puck. Unnecessary or dangerous contact could result in penalties being assessed to the offending player.

The puck striking or deflecting off an official does not automatically nullify a potential icing.



**81.2 Face-Off Location** – The resulting face-off following an icing call shall be at the end face-off spot of the offending team, unless on the play, the puck shall have entered the net of the opposing team, in which case the goal shall be allowed.

If during the period of a delayed whistle due to a foul by a player of the side not in possession, the side in possession “ices” the puck, then the face-off following the stoppage of play shall take place in the neutral zone near the defending blue line of the team icing the puck.

If, in the opinion of the Referee, the defending side intentionally abstains from playing the puck promptly when they are in a position to do so, he shall stop the play and order the resulting face-off on the adjacent corner face-off spot nearest the goal of the team at fault.

If the Linesman shall have erred in calling an “icing the puck” infraction (regardless of whether either team is short-handed), the puck shall be faced-off on the center ice face-off spot.

**81.3 Goalkeeper** - If, in the opinion of the Linesman, the goalkeeper feigns playing the puck, attempts to play the puck, or skates in the direction of the puck on an icing at any time, the potential icing shall not be called and play shall continue.

If, however, a goalkeeper is legitimately out of the crease in an attempt to go to the players’ bench to be substituted for an extra attacker and in no way makes an attempt to play the puck, the icing should not be nullified under this section.

If the goalkeeper is out of his crease prior to the shot being taken, and simply retreats to his crease making no attempt to play the puck or feign playing the puck, the potential icing shall remain in effect.

**81.4 Line Change on Icing** - A team that is in violation of this rule shall not be permitted to make any player substitutions prior to the ensuing face-off. Should the offending team elect to utilize their team time-out at this stoppage of play, they are still not permitted to make any player substitutions. However, a team shall be permitted to make a player substitution to replace a goalkeeper who had been substituted for an extra attacker, to replace an injured player, or when a penalty has been assessed which affects the on-ice strength of either team. The determination of players on ice will be made when the puck leaves the offending player’s stick.

**81.5 No Icing** – When the puck is shot and rebounds from the body or stick of an opponent in his own half of the ice so as to cross the goal line of the player shooting, it shall not be considered “icing.”

When a puck is shot by a team from their own half of the ice and is deflected several times before crossing the center red line, icing shall be nullified if at least one of these deflections was off an opposing player.

If a player of the side shooting the puck down the ice who is on-side and eligible to play the puck does so before it is touched by an opposing player, the play shall continue and it shall not be considered a violation of this rule.





If the puck shall go beyond the goal line in the opposite half of the ice directly from either of the players while facing-off, it shall not be considered a violation of this rule.

If, in the opinion of the Linesman, any player (other than the goalkeeper) of the opposing team is able to play the puck before it passes his goal line, but has not done so, play shall continue and the icing violation shall not be called. This includes the situation whereby the opposing team, while in the process of making player substitutions during the play, are able to play the puck, but choose not to do so to avoid being called for too many men on the ice. Icing should not be called.

The Linesman shall have discretion to wave off apparent icing infractions on attempted passes if those passes are deemed receivable (attainable). In order for the Linesman to wash out the icing for this reason, the receiving player's stick must be on the attacking side of the center red line and he must be eligible to receive the pass (e.g. he cannot be in an off-side position and cannot be involved in a player change that would result in a too many men on the ice penalty if he were to play the puck).

If the puck touches any part of a player of the opposing side, including his skates or his stick, or if it touches any part of the opposing team's goalkeeper, including his skates or his stick, at any time before or after crossing the goal line, it shall not be considered icing.

If a goalkeeper takes any action to dislodge the puck from the back of the net, icing shall not be called.

- 81.6 **Numerical Strength** – If the puck was so shot by a player of a side below the numerical strength of the opposing team, play shall continue and the icing violation shall not be called.

When a team is "short-handed" as the result of a penalty and the penalty is about to expire, the decision as to whether there has been an "icing" shall be determined at the instant the penalty expires. Should the puck be released from the stick of the player shooting the puck down the ice prior to the penalty expiring, the icing infraction shall not apply. The action of the penalized player remaining in the penalty box will not alter the ruling.

When a team is "short-handed" by reason of a major penalty, and they have neglected to ensure there is a player on the penalty bench to exit upon the expiry of the penalty, they will continue to play short-handed but are not permitted to ice the puck. Icing will be called. They may substitute for this penalized player at the next stoppage of play. See Rule 20.3 – Major Penalties.

## **Rule 82 – Line Changes**

- 82.1 **Line Change** - Following the stoppage of play, the visiting team shall promptly place a line-up on the ice ready for play and no substitution



shall be made from that time until play has been resumed. The home team may then make any desired substitution, except in cases following an icing, which does not result in the delay of the game.

“Placing a line-up on the ice” shall mean that both teams shall place the full complement of players (and not exceed) to which they are entitled within the line change time frame.

If there is any undue delay by either team in changing players, the Referee shall order the offending team or teams to take their positions immediately and not permit any further player changes.

When a substitution has been made under the above rule, no additional substitution may be made until play commences.

Once the line change procedure has been completed (82.2), no additional player substitutions shall be permitted until the face-off has been completed legally and play has resumed, except when a penalty or penalties are imposed that affect the on-ice strength of either or both teams. This may include penalties imposed following the completion of the line change and prior to the face-off, or due to a penalty assessed for a face-off violation.

A team that is in violation of Rule 81 – Icing shall not be permitted to make any player substitutions prior to the ensuing face-off. However, a team shall be permitted to make a player substitution to replace a goalkeeper who had been substituted for an extra attacker, to replace an injured player, or when a penalty has been assessed which affects the on-ice strength of either team. The determination of players on ice will be made when the puck leaves the offending player’s stick.

Goalkeepers’ substitution during a game will be conducted within the same time frame as a regular line change. No extra time will be allotted to the goalkeeper coming off the bench, except in the case where an injury to a goalkeeper occurs.

**82.2 Procedure** - Following a stoppage of play, the Referee will enforce the following line change procedure once he has determined that this procedure may begin:

- (i) *The Referee shall give the visiting team up to five (5) seconds to make its line change.*
- (ii) *The Referee shall raise his hand to indicate no further changes by the visiting team and to commence the home team’s line change.*
- (iii) *The Referee shall give the home team up to eight (8) seconds to make its line change.*
- (iv) *The Referee shall lower his hand to indicate no further changes by the home team.*
- (v) *Any attempt by the either team to make a change after the Referee’s signal, attempt to place too many men on the ice for the subsequent line change, or attempt to make additional personnel changes, shall not be permitted and the Referee will send the players who have attempted to change back to their players’ bench. The Referee will then issue a warning to the offending team (through the Coach)*



*indicating that any subsequent violations during the rest of the game (including overtime), shall result in a bench minor penalty for delaying the game. This penalty shall be announced as a “Bench Minor Penalty for Delay of Game – Improper Line Change.”*

- (vi) *The Linesman conducting the face-off will blow his whistle (once the Referee has lowered his hand for the line changes) to indicate that all players must be in position and on-side for the face-off within five (5) seconds. The face-off will then be conducted in accordance with Rule 76 – Face-offs.*
- (vii) *Players who are slow (after the five-second warning whistle given by the Linesman) getting to the face-off location or who are in an off-side position for the ensuing face-off will be warned once in the game by the Referee. This warning will also be given to the offending team’s Coach. In this situation, the offending team’s center is not ejected from the face-off. Any subsequent violation shall result in a bench minor penalty for delay of game being assessed to the offending team.*
- (viii) *In the last two (2) minutes of regulation time and any time in the overtime period(s), points (vi) and (vii) above are not applicable. The Linesman shall give the teams a reasonable amount of time to set up for the ensuing face-off after points (1) through (5) above have been enforced.*

**82.3 Bench Minor Penalty** - Any attempt by the visiting team to make a change after the Referee’s signal shall result in the assessment of a bench minor penalty for delay of game.

Players must proceed directly to the location of the face-off to participate in the ensuing face-off. Any attempts to delay the game by stalling or otherwise unnecessary actions by either team shall result in the assessment of a bench minor penalty for delaying the game. This penalty shall be announced as a “Bench Minor Penalty for Delay of Game – Slow Proceeding to Face-off Location (or, Slow Proceeding to Players’ Bench).”

During the play, if a player wishes to retire from the ice and be replaced by a substitute, he must do so at the players’ bench and not through any other exit leading from the rink. This is not a legal player change and therefore when a violation occurs, a bench minor penalty shall be imposed.

## **Rule 83 – Off-side**

**83.1 Off-side** - Players of the attacking team must not precede the puck into the attacking zone.

The position of the player’s skates and not that of his stick shall be the determining factor in all instances in deciding an off-side. A player is off-side when both skates are completely over the leading edge of the blue line involved in the play.

A player is on-side when either of his skates are in contact with, or on his own side of the line, at the instant the puck completely crosses the leading edge of the blue line regardless of the position of his stick.



However, a player actually controlling the puck who shall cross the line ahead of the puck shall not be considered “off-side,” provided he had possession and control of the puck prior to his skates crossing the blue line.

It should be noted that while the position of the player’s skates is what determines whether a player is “off-side,” nevertheless the question of an “off-side” never arises until the puck has completely crossed the leading edge of the blue line at which time the decision is to be made.

If a player legally carries or passes the puck back into his own defending zone while a player of the opposing team is in such defending zone, the off-side shall be ignored and play permitted to continue.

**83.2 Deflections / Rebounds** – When a defending player propels the puck out of his defending zone and the puck clearly rebounds off a defending player in the neutral zone back into the defending zone, all attacking players are eligible to play the puck. However, any action by an attacking player that causes a deflection/rebound off a defending player in the neutral zone back into the defending zone (i.e. stick check, body check, physical contact), a delayed off-side shall be signaled by the Linesman.

A puck that deflects back into the defending zone off an official who is in the neutral zone will be off-side (or delayed off-side, as appropriate).

**83.3 Delayed Off-Side** – A situation where an attacking player (or players) has preceded the puck across the attacking blue line, but the defending team is in a position to bring the puck back out of its defending zone without any delay or contact with an attacking player, or, the attacking players are in the process of clearing the attacking zone.

If an off-side call is delayed, the Linesman shall drop his arm to nullify the off-side violation and allow play to continue if:

- (i) *All players of the offending team clear the zone at the same instant (skate contact with the blue line) permitting the attacking players to re-enter the attacking zone, or*
- (ii) *The defending team passes or carries the puck into the neutral zone.*

If, during the course of the delayed off-side, any member of the attacking team touches the puck, attempts to gain possession of a loose puck, forces the defending puck carrier further back into his own zone, or who is about to make physical contact with the defending puck carrier, the Linesman shall stop play for the off-side violation.

If, during a delayed off-side, an attacking player in the attacking zone elects to proceed to his players’ bench (which extends into the attacking zone) to be replaced by a teammate, he shall be considered to have cleared the zone provided he is completely off the ice and his replacement comes onto the ice in the neutral zone. If his replacement comes onto the ice in the attacking zone, if the delayed off-side is still



in effect, he too must clear the attacking zone. If the remaining attacking players have cleared the attacking zone and the Linesman has lowered his arm for the delayed off-side, he shall be considered on-side.

- 83.4 Disallowed Goal** – If the puck is shot on goal during a delayed off-side, the play shall be allowed to continue under the normal clearing-the-zone rules. Should the puck, as a result of this shot, enter the defending team's goal, either directly or off the goalkeeper, a player or an official on the ice, the goal shall be disallowed as the original shot was off-side. The fact that the attacking team may have cleared the zone prior to the puck entering the goal has no bearing on this ruling. The face-off will be conducted at the face-off spot in the zone closest to the point of origin of the shot or at the nearest face-off spot in the neutral zone adjacent to the attacking zone of the offending team.

The only way an attacking team can score a goal on a delayed off-side situation is if the defending team shoots or puts the puck into their own net without action or contact by the offending team.

Other than in situations involving a delayed off-side and the puck being shot on goal, no goal can be disallowed after the fact for an off-side violation, except for the human factor involved in blowing the whistle.

- 83.5 Face-Off Location** - For violation of this rule, the play is stopped and the puck shall be faced-off in the neutral zone at the face-off spot nearest the attacking zone of the offending team when the violation occurs as a result of the attacking team carrying the puck over the attacking blue line, or from the face-off spot in the zone closest to the point of origin of the shot or pass (even if deflected off an attacking or defending player or an official).

For every delayed off-side situation, including an intentional off-side, the Linesman will raise his non-whistle arm. He will allow play to continue and, if a stoppage of play occurs, there will be three possible face-off locations:

- (i) *If carried over the blue line – face-off outside the blue line.*
- (ii) *If shot into the zone (or errant pass) – nearest face-off spot in the zone from which the pass or shot originated that gives the offending team the least amount of territorial advantage (even if deflected off an attacking or defending player or an official).*
- (iii) *If the defending player is pressured or about to be checked by an attacking player – nearest face-off spot in the zone from which the pass or shot originated that gives the offending team the least amount of territorial advantage (even if deflected off an attacking or defending player or an official).*
- (iv) *If deemed to be an intentional off-side – face-off spot in the offending team's end zone.*

When the Linesman signals a delayed off-side and a defending player shoots the puck which goes over the glass and out of play, the ensuing face-off shall be conducted at one of the defending zone end zone face-off spots (and the defending player would be assessed a



minor penalty under Rule 63 – Delaying the Game).

When the Linesman signals a delayed off-side and the original shot deflects off a defending player and out of play, the ensuing face-off shall take place at the nearest face-off spot in the zone from where the puck was shot.

When the defending team is about to be penalized in the defending zone and the Linesman has a delayed off-side signaled against the attacking team on the same play, the ensuing face-off shall be conducted at one of the defending zone end zone face-off spots.

**83.6 Intentional Off-Side** - An intentional off-side is one which is made for the purpose of securing a stoppage of play regardless of the reason, whether either team is short-handed.

If in the opinion of the Linesman, an intentional off-side play has been made, the puck shall be faced-off at the end face-off spot in the defending zone of the offending team.

If, while an off-side call is delayed, a player of the offending team deliberately touches the puck to create a stoppage of play, the Linesman will signal an intentional off-side.

If, in the judgement of the Linesman, the attacking player(s) are making an effort to exit the attacking zone and are in close proximity to the blue line at the time the puck is shot into the zone, the play will not be deemed to be an intentional off-side.

## **Rule 84 – Overtime**

**84.1 Overtime – Regular-season** - During regular-season games, if at the end of the three (3) regular twenty (20) minute periods, the score shall be tied, each team shall be awarded one point in the League standings.

The teams will then play an additional overtime period of not more than five (5) minutes with the team scoring first declared the winner and being awarded an additional point. The overtime period shall be played with each team at a numerical strength of four (4) skaters and one (1) goalkeeper. Additional penalties to be assessed consistent with the rules in regulation time.

The overtime period will be commenced immediately following a one (1) minute rest period during which the players will remain on the ice. The teams will not change ends for the overtime period. Goalkeepers may go to their respective players' benches during this rest period, however, penalized players must remain on the penalty bench. Should a penalized player exit the penalty bench during this rest period, he shall be returned immediately by the officials with no additional penalty being assessed, unless he commits an infraction of any other rule.



- 84.2 Overtime – Regular-season – Extra Attacker** - A team shall be allowed to pull its goalkeeper in favor of an additional skater in the overtime period. However, should that team lose the game during the time in which the goalkeeper has been removed, it would forfeit the automatic point gained in the tie at the end of regulation play, except if the goalkeeper has been removed at the call of a delayed penalty against the other team. Should the goalkeeper proceed to his bench for an extra attacker due to a delayed penalty call against the opposing team, and should the non-offending team shoot the puck directly into their own goal, the game shall be over and the team that was to be penalized declared the winner.

Once the goalkeeper has been removed for an extra attacker in overtime during the regular-season, he must wait for the next stoppage of play before returning to his position. He cannot change “on the fly.” If he does, a bench minor penalty shall be assessed for having an ineligible player.

- 84.3 Overtime – Regular-season – Penalties** – When regulation time ends and the teams are 5 on 3, teams will start overtime 5 on 3. Once player strength reaches 5 on 4 or 5 on 5, at the next stoppage of play, player strength is adjusted to 4 on 3 or 4 on 4, as appropriate.

When regulation ends and teams are 4 on 4 teams will start overtime 3 on 3.

If at the end of regulation time teams are three (3) skaters on three (3) skaters, overtime starts three (3) skaters on three (3) skaters. Once player strength reaches five (5) skaters on four (4) skaters or five (5) skaters on five (5) skaters, at the next stoppage player strength is adjusted to four (4) skaters on three (3) skaters or four (4) skaters on four (4) skaters, as appropriate.

At no time will a team have less than three players on the ice. This may require a fifth skater to be added if a two-man advantage occurs.

Refer to Reference Tables – Table 19 – Penalties In Effect Prior to the Start of Overtime – Regular Season on page 157.

If a team is penalized in overtime, teams play four (4) skaters against three (3) skaters. If both teams are penalized with minor penalties at the same stoppage of play (with no other penalties in effect), teams will play three (3) skaters against three (3) skaters.

In overtime, if a team is penalized such that a two-man advantage is called for, then the offending team will remain at three (3) skaters while the non-offending team will be permitted a fifth skater.

At the first stoppage of play after the two-man advantage is no longer in effect, the numerical strength of the team will revert back to either four (4) skaters on four (4) skaters or a four (4) skaters on three (3) skaters situation, as appropriate.

Refer to Reference Tables – Table 20 – Penalties Assessed in Overtime – Regular Season on page 158.

- 84.4 Shootout** - During regular-season games, if the game remains tied at



the end of the five (5) minute overtime period, the teams will proceed to a shootout. The rules governing the shootout shall be the same as those listed under Rule 25 - Penalty Shot.

The teams will not change ends for the shootout. The home team shall have the choice of shooting first or second. The teams shall alternate shots.

Three (3) players from each team shall participate in the shootout and they shall proceed in such order as the Coach selects. All players are eligible to participate in the shootout unless they are serving a ten-minute misconduct or have been assessed a game misconduct or match penalty. When a goalkeeper has been assessed a misconduct, the player designated to serve the misconduct penalty becomes ineligible for the shootout. If the misconduct is assessed to the goalkeeper during the course of the shootout, the player designated to serve the misconduct must be a player who has yet to shoot and thus becomes ineligible to shoot.

Guidelines related to stick measurement requests during the shootout are outlined in 10.7 – Stick Measurements – Prior to Shootout Attempt.

Once the shootout begins, the goalkeeper cannot be replaced unless he is injured. No warm up shall be permitted for a substitute goalkeeper.

Each team will be given three shots, unless the outcome is determined earlier in the shootout. After each team has taken three shots, if the score remains tied, the shootout will proceed to a "sudden death" format. No player may shoot twice until everyone who is eligible has shot. If, however, because of injury or penalty, one team has fewer players eligible for the shootout than its opponent, both teams may select from among the players who have already shot. This procedure would continue until the team with fewer players has again used all eligible shooters.

Regardless of the number of goals scored during the shootout portion of overtime, the final score recorded for the game will give the winning team one more goal than its opponent, based on the score at the end of overtime.

The losing goalkeeper will not be charged with the extra goal against. The player scoring the game-winning goal in the shootout will not be credited with a goal scored in his personal statistics.

If a team declines to participate in the shootout procedure, the game will be declared as a shootout loss for that Team. If a team declines to take a shot it will be declared as "no goal."

**84.5 Overtime – Playoffs** – In the Stanley Cup Playoffs, when a game is tied after three (3) twenty (20) minute regular periods of play, the teams shall take a fifteen (15) minute intermission and resume playing twenty (20) minute periods, changing ends for the start of each overtime period. The team scoring the first goal in overtime shall be declared the winner of the game.





## **Rule 85 – Puck Out of Bounds**

**85.1 Puck Out of Bounds** - When a puck goes outside the playing area at either end or either side of the rink, strikes any obstacles above the playing surface other than the boards or glass, causes the glass, lighting, timing device or the supports to break, it shall be faced-off at the nearest face-off spot in the zone from where it was shot or deflected out of play, except when the attacking team in the attacking zone is responsible for causing the puck to go out of play, the ensuing face-off shall take place at the nearest face-off spot in the neutral zone outside the offending team's attacking zone. One exception to the above shall be when the puck deflects off the goal post or crossbar, when caused by either team, either shot directly or deflected off any player or official, the face-off shall always be conducted in that end zone at the nearest face-off spot.

If the puck comes to rest on top of the boards surrounding the playing area, it shall be considered to be in play and may be played legally by hand or stick.

When the puck goes outside the playing area directly off the face-off, regardless as to which player may have last contacted the puck, the face-off shall remain in the same spot and no penalty will be assessed to either team for delaying the game.

When the puck is shot and it makes contact with the gloves or the body of a player hanging over the players' bench, or if the puck enters the players' bench through an open bench door, the face-off shall take place at the nearest face-off spot in the zone from where the puck was shot, however, if the puck hits an opposing player's glove or body that is hanging over the opposing team's players' bench or enters the opposing team's players' bench through an open bench door, the face-off shall take place in the neutral zone adjacent to the opponent's players' bench.

Should the puck strike the spectator netting at the ends and the corners of the arena, play shall be stopped and the ensuing face-off shall be determined as if the puck went outside the playing area. However, if the puck striking the spectator netting goes unnoticed by the on-ice officials, play shall continue as normal and resulting play with the puck shall be deemed a legitimate play. Players must not stop playing the game until they hear the whistle to do so.

**85.2 Puck Unplayable** - When the puck becomes lodged in the netting on the outside of either goal so as to make it unplayable, or if it is "frozen" between opposing players intentionally or otherwise, the Referee shall stop the play.

The puck may be played off the goal netting by either team. However, should the puck remain on the goal netting for more than three (3) seconds, play shall be stopped. Should the goalkeeper use his stick or glove to freeze the puck on the back of the net or should a defending player shield an attacking player from playing the puck off the back of the net, the face-off shall take place at one of the face-off spots in the defending zone.



Should the puck go under the goal either from behind or the side, or through the mesh from behind or the side, if this is witnessed by an on-ice official, play should be stopped immediately and the ensuing face-off should take place at the nearest face-off spot in the zone nearest to the location where the play was stopped.

**85.3 Puck Out of Sight** - Should a scramble take place or a player accidentally fall on the puck and the puck be out of sight of the Referee, he shall immediately blow his whistle and stop the play. The puck shall then be faced-off at the nearest face-off spot in the zone where the play was stopped unless otherwise provided for in the rules.

**85.4 Puck Striking Official** - Play shall not be stopped if the puck touches an official anywhere on the rink, regardless of whether a team is short-handed or not.

A puck that deflects back into the defending zone off an official who is in the neutral zone, will be deemed to be off-side as per Rule **83 – Off-side**.

The puck striking or deflecting off an official does not automatically nullify a potential icing.

When a puck deflects off an official and goes out of play, the ensuing face-off will take place at the face-off spot in the zone nearest to where the puck deflected off the official.

If a goal is scored as a result of being deflected directly into the net off an official, the goal shall not be allowed.

**85.5 Face-Off Location** - Notwithstanding this rule, should an attacking player cause the puck to go out of play or become unplayable in the attacking zone, the face-off shall take place at a neutral zone face-off spot or at a face-off spot in the zone from which the puck left the ice, whichever is less advantageous to the attacking team.

For a puck that is unplayable due to being lodged in the netting or as a result of it being frozen between opposing players, the resulting face-off shall be at either of the adjacent face-off spots unless in the opinion of the Referee, the stoppage was caused by the attacking team, in which case the resulting face-off shall be conducted in the neutral zone.

When the puck hits the goal post or crossbar and goes out of play, regardless which team shot the puck, the ensuing face-off shall take place at one of the end zone face-off spots in the zone where the puck went out of play. If, however, the attacking team shoots the puck into the zone and a delayed off-side is indicated, or if the attacking team contacts the puck with a high-stick or bats the puck with a glove and it then deflects off the goal post or crossbar and goes out of play, the ensuing face-off shall be in the neutral zone outside the offending team's attacking zone.

**85.6 Minor Penalty** – A minor penalty for delay of game shall be imposed on a goalkeeper who deliberately drops the puck on the goal netting to cause a stoppage of play.



- 85.7 **Verification of Time** - Any loss of time on the game or penalty clocks due to the puck going out of play must be replaced. The Video Goal Judge may be consulted to ensure the time is accurately replaced.

## **Rule 86 – Start of Game and Periods**

- 86.1 **Start of Game and Periods** - The game shall be commenced at the time scheduled by a “face-off” in the center of the rink and shall be renewed promptly at the conclusion of each intermission in the same manner.
- 86.2 **Bench Minor Penalty** – A bench minor penalty shall be imposed on either or both teams if they are not on the ice or can be seen proceeding to the ice to start the second, third or any overtime period when the intermission time on the clock has expired.

At the start of the second, third and any overtime period, all players with the exception of the starting players must proceed directly to their respective players' benches. Skating, warm-ups or on-ice activities by non-starters will result in a bench minor penalty for delay of game to the offending team.

When the visiting team must proceed by the way of the ice to their dressing room at the end of a period, they must wait for a signal from one of the officials before proceeding. Failure to wait for the official's signal shall result in the assessment of a bench minor penalty for delay of game.

- 86.3 **Choice of Ends** - Home clubs shall have the choice of goals to defend at the start of the game except where both players' benches are on the same side of the rink, in which case the home club shall start the game defending the goal nearest to its own bench. The teams shall change ends for each period of regulation time and, in the playoffs, for each period of overtime. (See Rule **84** – Overtime)
- 86.4 **Delays** - No delay shall be permitted by reason of any ceremony, exhibition, demonstration or presentation unless consented to reasonably in advance by the visiting team.
- 86.5 **End of Periods** - At the end of each period, the home team players must proceed directly to their dressing room while the visiting team players must wait for a signal from the official to proceed only if they have to go on the ice to reach their dressing room. Failure to comply with this regulation will result in a bench minor penalty for delay of game.
- Players shall not be permitted to come on the ice during a stoppage of play or at the end of the first and second periods for the purpose of warming-up. The Referee will report any violation of this rule to the Commissioner for disciplinary action.
- 86.6 **Pre-Game Warm-Up** - During the pre-game warm-up (which shall not exceed sixteen (16) minutes in duration) and before the commencement of play in any period, each team shall confine its activity to its own end of the rink. Refer to Rule **47.9** - Fighting.



The Game Timekeeper shall be responsible for signaling the commencement and termination of the pre-game warm-up and any violation of this rule by the players shall be reported to the Commissioner.

Twenty (20) minutes before the time scheduled for the start of the game, both teams shall vacate the ice and proceed to their dressing rooms while the ice is being flooded. Both teams shall be signaled by the Game Timekeeper to return to the ice together in time for the scheduled start of the game.

**86.7 Start of Game** - At the beginning of the game, if a team fails to appear on the ice promptly without proper justification, a fine shall be assessed against the offending team, the amount of the fine to be decided by the Commissioner.

**86.8 Start of Periods** - At the beginning of the second and third periods, and overtime periods in playoffs (0:00 on the clock), clubs must be on the ice or be observed to be proceeding to the ice. Failure to comply with this regulation will result in a bench minor penalty for delay of game.

Before the start of the second and third periods (and overtime periods in the playoffs), the teams will proceed directly to their respective players' benches. Only the starting line-up will be allowed on the ice. The visiting team will immediately place its starting line-up at the face-off circle, then the home team will follow, with the Referee allowing the home team to make a line change if so desired prior to the face-off. Skating, warm-ups or on-ice activities by non-starters will result in a bench minor penalty for delay of game to the offending team.

No warm-up involving pucks on the ice shall be permitted for a goalkeeper at the start of any period. If, after one warning, this continues, the Referee shall assess a delay of game penalty to the offending team.

## **Rule 87 – Time-outs**

**87.1 Time-out** - Each team shall be permitted to take one thirty-second time-out during the course of any game, regular season or playoffs. All players including goalkeepers on the ice at the time of the time-out will be allowed to go to their respective benches.

This time-out must be taken during a normal stoppage of play. Only one time-out, commercial or team, shall be permitted at any one stoppage of play. For the purpose of this rule, a commercial time-out is deemed an "official time-out" and not charged to either team.

Any player designated by the Coach will indicate to the Referee (prior to the drop of the puck) that his team is exercising its option and the Referee will report the time-out to the Game Timekeeper who shall be responsible for signaling the termination of the time-out.

No time-out shall be granted following a face-off violation.



## SECTION 10 – GAME FLOW



When a penalty shot has been awarded to either team by the Referee, no time-out will be granted once instructions have been given to the player taking the shot and the goalkeeper defending the shot. No time-out will be granted during the shootout.

No warm-up involving pucks on the ice shall be permitted for a goalkeeper or replacement goalkeeper during a time-out. If, after one warning, this continues, the Referee shall assess a delay of game penalty to the offending team.



**TABLE 1**  
**(Rule 15 – Calling of Penalties)**  
**SUMMARY OF PENALTIES TO COACHES AND NON-PLAYING CLUB PERSONNEL**

Description	Rule
(i) Hitting the boards with a stick	Rule 40.3
(ii) Interference with an opponent on a breakaway	Rule 56.6
(iii) Interference with an opponent or the puck while play is in progress	Rule 56.3
(iv) Interference with an opponent or the puck while the goalkeeper has been removed	Rule 56.7
(v) Interfering with an official	Rule 40.3
(vi) Leaving the bench by stepping onto the ice before the end of the period	Rule 70.5
(vii) Obscene language or gestures	Rule 40.3      Rule 75.3 Rule 40.5      Rule 75.5
(viii) Physically abusing an official	Rule 41.7
(ix) Refusing to start play (teams in their dressing room)	Rule 73.3
(x) Refusing to start play (teams on the ice)	Rule 73.2
(xi) Throwing a stick on the ice to a player who has lost or broken a stick	Rule 40.3
(xii) Throwing any object onto the ice	Rule 75.3
(xiii) Throwing stick (breakaway on an open net)	Rule 53.7
(xiv) Throwing stick (defending zone)	Rule 53.6

**TABLE 2**  
**(Rule 16 – Minor Penalties)**  
**SUMMARY OF MINOR PENALTIES**

Description	Rule
(i) Boarding	Rule 42
(ii) Broken stick	Rule 10
(iii) Charging	Rule 43
(iv) Clipping	Rule 45
(v) Closing hand on puck	Rule 67
(vi) Cross-checking	Rule 59
(vii) Delay of game	Rule 63
(viii) Elbowing	Rule 46
(ix) Goalkeeper interference	Rule 69
(x) High-sticking	Rule 60
(xi) Holding	Rule 54
(xii) Holding the stick	Rule 54
(xiii) Hooking	Rule 55
(xiv) Illegal equipment	Rule 12
(xv) Illegal stick	Rule 10



**TABLE 2**  
**(Rule 16 – Minor Penalties)**  
**SUMMARY OF MINOR PENALTIES**

Description	Rule
(xvi) Instigator	Rule 47
(xvii) Interference	Rule 56
(xviii) Kneeing	Rule 50
(xix) Leaving penalty bench too early	Rule 70
(xx) Leaving the crease (goalkeeper)	Rule 28
(xxi) Participating in the play beyond the center red line (goalkeeper)	Rule 28
(xxii) Roughing	Rule 51
(xxiii) Slashing	Rule 61
(xxiv) Throwing puck towards opponent's goal (goalkeeper)	Rule 67
(xxv) Throwing stick	Rule 53
(xxvi) Tripping	Rule 57
(xxvii) Unsportsmanlike conduct	Rule 75

**TABLE 3**  
**(Rule 17 – Bench Minor Penalties)**  
**SUMMARY OF BENCH MINOR PENALTIES**

Description	Rule
(i) Abuse of officials	Rule 40
(ii) Delay of game	Rule 63
(iii) Deliberate illegal substitution	Rule 74
(iv) Face-off violation	Rule 76
(v) Illegal substitution	Rule 68
(vi) Improper starting line-up	Rule 7
(vii) Interference from players' or penalty bench	Rule 56
(viii) Interference with an official	Rule 40
(ix) Leaving bench at end of period	Rule 86
(x) Refusing to start play	Rule 73
(xi) Stepping onto ice during period (Coach)	Rule 70
(xii) Throwing objects onto ice	Rule 63
(xiii) Too many men on the ice	Rule 74
(xiv) Unsportsmanlike conduct	Rule 75
(xv) Unsustained request for measurement	Rule 10



**TABLE 4**  
**(Rule 18 – Double-minor Penalties)**  
**SUMMARY OF DOUBLE-MINOR PENALTIES**

Description	Rule
(i) Butt-ending	Rule 58
(ii) Head-butting	Rule 48
(iii) High-sticking	Rule 60
(iv) Spearing	Rule 62

**TABLE 5**  
**(Rule 20 – Major Penalties)**  
**SUMMARY OF MAJOR PENALTIES**

Description	Rule
(i) Boarding	Rule 42
(ii) Butt-ending	Rule 58
(iii) Charging	Rule 43
(iv) Checking from behind	Rule 44
(v) Clipping	Rule 45
(vi) Cross-checking	Rule 59
(vii) Elbowing	Rule 46
(viii) Fighting	Rule 47
(ix) Head-butting	Rule 48
(x) Hooking	Rule 55
(xi) Interference	Rule 56
(xii) Kneeing	Rule 50
(xiii) Slashing	Rule 61
(xiv) Spearing	Rule 62

**TABLE 6**  
**(Rule 20 – Major Penalties)**  
**SUMMARY OF MAJOR PENALTIES THAT RESULT IN AN AUTOMATIC GAME MISCONDUCT**

Description	Rule
(i) Butt-ending	Rule 58
(ii) Checking from behind	Rule 44
(iii) Clipping	Rule 45
(iv) Cross-checking	Rule 59
(v) Fighting (after original altercation)	Rule 47
(vi) Fighting (when aggressor)	Rule 47
(vii) Fighting (second instigator in game)	Rule 47





**TABLE 6**  
**(Rule 20 – Major Penalties)**  
**SUMMARY OF MAJOR PENALTIES THAT RESULT IN AN AUTOMATIC GAME MISCONDUCT**

(viii) Fighting (instigator in final 5 minutes)	Rule 47
(ix) Fighting (third instigator in season)	Rule 47
(x) Head-butting	Rule 48
(xi) Hooking	Rule 55
(xii) Kneeing	Rule 50
(xiii) Slashing	Rule 61
(xiv) Spearing	Rule 62

**TABLE 7**  
**(Rule 20 – Major Penalties)**  
**SUMMARY OF MAJOR PENALTIES THAT RESULT IN AN AUTOMATIC GAME MISCONDUCT WHEN THERE IS AN INJURY TO THE FACE OR HEAD**

Description	Rule
(i) Boarding	Rule 42
(ii) Charging	Rule 43
(iii) Elbowing	Rule 46

**TABLE 8**  
**(Rule 21 – Match Penalties)**  
**SUMMARY OF MATCH PENALTIES**

Description	Rule
(i) Attempt to injure (in any manner)	Rule 21
(ii) Biting	Rule 21
(iii) Boarding	Rule 42
(iv) Butt-ending *	Rule 58
(v) Charging	Rule 43
(vi) Checking from behind	Rule 44
(vii) Clipping	Rule 45
(viii) Cross-checking	Rule 59
(ix) Deliberate injury (in any manner)	Rule 21
(x) Elbowing	Rule 46
(xi) Goalkeeper who uses his blocking glove to the head or face of an opponent*	Rule 51
(xii) Grabbing of the face mask	Rule 21
(xiii) Hair pulling	Rule 21



**TABLE 8**  
**(Rule 21 – Match Penalties)**  
**SUMMARY OF MATCH PENALTIES**

Description	Rule
(xiv) Head-butting *	Rule 48
(xv) High-sticking	Rule 60
(xvi) Kicking a player (or goalkeeper)	Rule 49
(xvii) Kneeing	Rule 50
(xviii) Punching and injuring an unsuspecting opponent *	Rule 47
(xix) Slashing	Rule 61
(xx) Slew-footing	Rule 52
(xxi) Spearing *	Rule 62
(xxii) Throwing stick or any object	Rule 53
(xxiii) Wearing tape on hands in altercation *	Rule 47

\* NOTE - match penalty must be assessed when injury results

**TABLE 9**  
**(Rule 22 – Misconduct Penalties)**  
**SUMMARY OF MISCONDUCT PENALTIES**

Description	Rule
(i) Banging boards with stick in protest of an official's ruling	Rule 40
(ii) Continuing or attempting to continue a fight	Rule 47
(iii) Deliberately breaking stick or refusing to surrender stick for measurement	Rule 10
(iv) Deliberately throwing any equipment (including stick) out of playing area	Rule 40      Rule 53
(v) Entering or remaining in the referee's crease	Rule 40
(vi) Fighting off the playing surface (or with another player who is off the playing surface)	Rule 47
(vii) Inciting an opponent	Rule 75
(viii) Instigating a fight	Rule 47
(ix) Interfering or distracting opponent taking a penalty shot	Rule 25
(x) Knocking or shooting puck out of reach of an official	Rule 40
(xi) Leaving bench to speak to official	Rule 6
(xii) Refusing to change non-regulation piece of protective equipment (second violation)	Rule 9
(xiii) Use of profane or abusive language	Rule 75
(xiv) Verbal abuse of an official	Rule 40



**TABLE 10**  
**(Rule 23 – Game Misconduct Penalties)**  
**SUMMARY OF GAME MISCONDUCT FOULS INCLUDED IN THE**  
**“GENERAL CATEGORY”**

Description	Rule
(i) Charging	Rule 43
(ii) Clipping	Rule 45
(iii) Elbowing	Rule 46
(iv) Fighting off the playing surface	Rule 47
(v) Head-butting	Rule 48
(vi) Inciting an opponent into incurring a penalty	Rule 75
(vii) Interference	Rule 56
(viii) Intervening in an altercation	Rule 47
(ix) Kneeing	Rule 50
(x) Not properly tied down during an altercation	Rule 47
(xi) Obscene language or gestures	Rule 40
(xii) Persists in continuing an altercation	Rule 47
(xiii) Removing jersey prior to an altercation	Rule 47
(xiv) Resisting a Linesman in the discharge of his duties	Rule 40
(xv) Secondary altercation	Rule 47
(xvi) Third major penalty in a game	Rule 20
(xvii) Throwing stick outside the playing area	Rule 53
	Rule 75

**TABLE 11**  
**(Rule 23 – Game Misconduct Penalties)**  
**SUMMARY OF GAME MISCONDUCT FOULS INCLUDED IN THE**  
**“STICK-RELATED CATEGORY”**

Description	Rule
(i) Butt-ending	Rule 58
(ii) Cross-checking	Rule 59
(iii) Hooking	Rule 55
(iv) Slashing	Rule 61
(v) Spearing	Rule 62



**TABLE 12**  
**(Rule 23 – Game Misconduct Penalties)**  
**SUMMARY OF GAME MISCONDUCT PENALTIES**

Description	Rule	
(i) Continues or attempts to continue a fight	Rule 47	
(ii) Fighting off the playing surface or with an opponent who is off the playing surface	Rule 47	
(iii) First or second player to leave the players' bench during or to start an altercation	Rule 70	
(iv) First to intervene in an altercation (third man in)	Rule 47	
(v) Interferes with a game official in the performance of their duties	Rule 40	
(vi) Leaving the penalty bench during an altercation	Rule 70	
(vii) Obscene gestures	Rule 40	Rule 75
(viii) Persists to challenge or dispute an official's ruling	Rule 40	
(ix) Physically abuses an official	Rule 41	
(x) Player who has been ordered to the dressing room but returns to the bench or the ice	Rule 70	
(xi) Player who deliberately attempts to injure a Manager, Coach or other non-playing Club personnel in any manner.	Rule 75	

**TABLE 13**  
**(Rule 25 – Penalty Shot)**  
**SUMMARY OF PENALTY SHOTS**

Description	Rule	
(i) Deliberate illegal substitution	Rule 68	
(ii) Intentionally dislodging the net from its moorings during the course of a breakaway	Rule 63	
(iii) Intentionally dislodging the net from its moorings when the penalty cannot be served in its entirety within regulation time	Rule 63	
(iv) Falling on the puck in the goal crease	Rule 63	
(v) Picking up the puck with the hand in the goal crease	Rule 63	
(vi) Player on a breakaway who is interfered with by an object thrown or shot by a defending team player	Rule 53	Rule 56
(vii) Player on a breakaway who is interfered with by a player who has illegally entered the game	Rule 70	
(viii) Player throws or shoots an object at the puck in his defending zone	Rule 53	
(ix) Player on a breakaway who is fouled from behind.	Rule 25 Rule 54 Rule 55	Rule 57 Rule 61



**TABLE 14**  
**(Rule 26 – Awarded Goals)**  
**SUMMARY OF AWARDED GOALS (WHEN GOALKEEPER HAS BEEN REMOVED FOR AN EXTRA ATTACKER)**

Description	Rule
(i) Delaying the game	Rule 63
(ii) Handling the puck	Rule 67
(iii) Illegal substitution	Rule 68
(iv) Interference	Rule 56
(v) Leaving the players' or penalty bench	Rule 70
(vi) Throwing stick	Rule 53
(vii) Tripping (fouling from behind – including hooking, holding, slashing, etc.)	Rule 57

**TABLE 15**  
**(Rule 28 – Goalkeeper's Penalties)**  
**SUMMARY OF GOALKEEPER PENALTIES**

Description	Rule
(i) Illegal stick	Rule 10
(ii) Illegal equipment	Rule 9      Rule 12
(iii) Leaving crease during an altercation	Rule 28
(iv) Proceeding to players' bench	Rule 28
(v) Participates in the play beyond the center red line	Rule 28
(vi) Playing puck in restricted area	Rule 1      Rule 63 Rule 28
(vii) Proceeds to players' bench to replace stick	Rule 10
(viii) Deliberately shoots or bats puck out of play	Rule 63
(ix) Deliberately falls on the puck inside or outside the goal crease	Rule 63
(x) Deliberately drops the puck in his pads or on the goal net	Rule 67
(xi) Piling snow or other obstacles	Rule 67
(xii) Throwing the puck towards opponent's goal	Rule 67
(xiii) Using blocking glove to punch an opponent in the head or face	Rule 51



**TABLE 16**  
**(Rule 16 – Minor Penalties)**  
**GOALS SCORED AGAINST A SHORT-HANDED TEAM**

Ex	Time	Team A	Team B	Answer	Remarks
Minor penalty expiration criteria:					
a.	Is the team scored against, short-handed?				
b.	Are they serving a minor penalty on the clock?				
c.	If the answer is yes to a) and b), delete the minor penalty with the least amount of time on the clock, except when coincidental penalties are being served.				
<b>One player with a double minor penalty:</b>					
A1	3:00	A15 – 2+2		No player returns	First penalty ends, the second begins at 4:30.
	4:30		Goal		
A2	3:00	A15 – 2+2		A15 returns.	The first penalty has expired, the second ends with the scoring of the goal.
	5:30		Goal		
<b>One player with a minor and a major penalty:</b>					
B1	3:00	A15 – 5+2		No penalty terminates.	The major penalty must be served first.
	4:30		Goal		
B2	3:00	A15 – 5+2		A15 returns.	The major penalty has expired, the minor penalty ends with the scoring of the goal.
	8:30		Goal		
<b>Two players of the same team – combination of minor and major penalties:</b>					
C1	3:00	A15 – 2		A15 returns.	
	4:00	A23 – 2			
	4:30		Goal		
C2	3:00	A15 – 2		A15 returns.	
	4:00	A23 – 5			
	4:30		Goal		
C3	3:00	A15 – 5		A23 returns.	
	4:00	A23 – 2			
	4:30		Goal		
C4	3:00	A15 – 2+2			The first minor to A15 ends.  A23 returns because he has the least amount of time to serve in his minor penalty.
	4:00	A23 – 2			
	4:30		Goal	No player returns.	
	5:30		Goal	A23 returns.	
C5	3:00	A15 – 2		A15 returns.	The signaled double-minor penalty to A23 is assessed at 4:30.
	(S*)	A23 – 2+2			



**TABLE 16**  
**(Rule 16 – Minor Penalties)**  
**GOALS SCORED AGAINST A SHORT-HANDED TEAM**

Ex	Time	Team A	Team B	Answer	Remarks
	4:30		Goal		* S = signaled
C6	3:00	A15 – 5+2		A23 returns.	A15 must first serve his major penalty. A23 returns as he is serving a minor penalty.
	4:00	A23 – 2			
	4:30		Goal		
C7	3:00	A15 – 5+2		A23 returns.	Least amount of time to serve.
	7:30	A23 – 2			
	8:30		Goal		
C8	3:00	A15 – 5+2		Both A15 and A23 return.	The major penalty to A15 has expired. His minor penalty ends with the goal. A23's minor penalty has expired.
	6:00	A23 – 2			
	8:00		Goal		
C9	3:00	A15 – 5+2		Captain's choice.	The major penalty to A15 has expired. Both minors terminate at the same time.
	8:00	A23 – 2			
	9:00		Goal		
<b>Three players of the same team – Delayed (D) or Signaled (S) penalty (no stoppage of play):</b>					
D1	3:00	A15 – 2			Delayed penalty to A6 begins at 4:30
	3:30	A23 – 2			
	4:00	A6 – 2(D)			
	4:30		Goal	A15 returns.	
	5:00		Goal	A23 returns.	
	5:30		Goal	A6 returns.	
D2	3:00	A15 – 2			
	3:30	A23 – 2			
	(S)	A6 – 2			
	4:30		Goal	A15 returns and the penalty to A6 starts.	



**TABLE 16**  
**(Rule 16 – Minor Penalties)**  
**GOALS SCORED AGAINST A SHORT-HANDED TEAM**

Ex	Time	Team A	Team B	Answer	Remarks
	5:00		Goal	A23 returns and A6 remains in the box.	
D3	3:00	A15 – 5		A23 returns and the penalty to A6 starts.	
	3:30	A23 – 2			
	(S)	A6 – 2			
	4:30		Goal		
D4	3:00	A15 – 5		A15 and A23 return and the penalty to A6 starts.	The major penalty to A15 is completed. The minor penalty to A23 ends on the scoring of the goal.
	7:30	A23 – 2			
	(S)	A6 – 2			
	8:00		Goal		
<b>One player from each team – combination of minors and majors:</b>					
E1	3:00	A15 - 2			
	3:30		B12 – 2		
	4:30		Goal	No player returns.	Teams are at equal strength.
	5:00		Goal	A15 returns.	His minor penalty has been completed.
E2	3:00	A15 – 5+2		No player returns.	Teams are at equal strength.
	3:30		B12 – 2		
	4:30		Goal		
E3	3:00	A15 – 5+2		No player returns.	The major penalty to A15 is complete but the teams remain at equal strength.
	7:30		B12 – 2		
	8:00		Goal		





**TABLE 16**  
**(Rule 16 – Minor Penalties)**  
**GOALS SCORED AGAINST A SHORT-HANDED TEAM**

Ex	Time	Team A	Team B	Answer	Remarks
E4	3:00	A15 – 2+2			
	3:30		B12 – 2		
	4:30		Goal	No player returns.	Teams are at equal strength.
	5:00		Goal	No player returns.	The first minor to A15 is competed but teams remain at equal strength.
	5:30		Goal	A15 returns.	The first minor penalty to A15 and that of B12 are complete. The second minor penalty to A15 ends with the scoring of the goal.
E5	3:00	A15 – 5+2		A15 returns.	The major penalty to A15 and the minor penalty to B12 have expired. The minor penalty to A15 ends on the scoring of the goal.
	6:00		B12 – 2		
	8:00		Goal		
E6	3:00	A15 – 2		No player returns.	The goal nullifies the signaled penalty to A23 (Reason: Team A was not short-handed).
	3:30		B12 – 2		
	(S)	A23 – 2			
	4:10		Goal		
<b>Unequal number of players – combination of minors and majors:</b>					
F1	3:00	A15 – 2		A15 returns.	He had the least amount of time to serve in his minor penalty.
	3:30		B12 – 2		
	4:00	A23 – 2			
	4:30		Goal		
F2	3:00	A15 – 2		A15 returns.	His minor penalty is completed. Teams are at equal strength at the time of the goal.
	3:30		B12 – 2		
	4:00	A23 – 2			
	5:00		Goal		



**TABLE 16**  
**(Rule 16 – Minor Penalties)**  
**GOALS SCORED AGAINST A SHORT-HANDED TEAM**

Ex	Time	Team A	Team B	Answer	Remarks
F3	3:00	A15 – 2		A15 returns.	
	3:30	A23 – 2			
	4:00		B12 – 2		
	4:30		Goal		
F4	3:00		B12 – 2	A15 returns.	Least amount of time to serve in his minor penalty.
	3:30	A15 – 2			
	4:00	A23 – 5			
	4:30		Goal		
F5	3:00		B12 – 2		Least amount of time to serve in his minor penalty.
	3:30	A15 – 2			
	4:00	A23 – 2			
	4:30		Goal	A15 returns.	
	5:00		Goal	A23 returns	
F6	3:00	A15 – 5		A23 returns.	Least amount of time (and Team A is short-handed by reason of a minor penalty).
	3:30		B12 – 5		
	4:00	A23 – 2			
	4:30		Goal		
F7	3:00	A15 – 2		A15 returns.	Least amount of time (and Team A is short-handed by reason of a minor penalty).
	3:30		B12 – 5		
	4:00	A23 – 5			
	4:30		Goal		
F8	3:00	A15 – 5		A23 returns.	Short-handed by reason of a minor penalty.
	3:30	A23 – 2			
	4:00		B12 – 2		
	4:30		Goal		



**TABLE 16**  
**(Rule 16 – Minor Penalties)**  
**GOALS SCORED AGAINST A SHORT-HANDED TEAM**

Ex	Time	Team A	Team B	Answer	Remarks
F9	3:00	A15 – 5	B12 – 2	A23 returns.	Short-handed by reason of a minor penalty.
	3:30				
	4:00	A23 – 2			
	4:30	Goal			
F10	3:00	A15 – 2	B12 – 2	A15 returns.	Short-handed by reason of a minor penalty.
	3:30	A23 – 5			
	4:00				
	4:30	Goal			
F11	3:00		B12 – 5	A15 returns.	Least amount of time.
	3:30	A15 – 2			
	4:00	A23 – 2			
	4:30	Goal			
F12	3:00	A15 – 2+2	B12 – 2	No player returns.	First minor penalty to A15 ends.
	3:30				
	4:00	A23 – 2			
	4:30	Goal			
F13	3:00	A15 – 2	B12 – 2	A15 returns.	The penalty to A6 begins at 4:00
	3:15	A23 – 2			
	3:30				
	3:45	A6 – 2(D)			
	4:00	Goal			
	4:30	Goal			
F14	3:00	A15 – 2	B12 – 2	A23 returns.	Penalties to A6 and B3 are not on the clock.
	3:15	A23 – 2			
	3:30	A6 – 2	B3 – 2		
	5:10		Goal		



**TABLE 16**  
**(Rule 16 – Minor Penalties)**  
**GOALS SCORED AGAINST A SHORT-HANDED TEAM**

Ex	Time	Team A	Team B	Answer	Remarks
F15	3:00	A15 – 2	B12 – 2	Signaled penalty to B3 is not assessed.	The penalty to B12 does not make Team B short-handed.
	3:30				
	4:00	A23 – 2			
	(S)	B3 - 2			
	4:30	Goal			
F16	3:00	A15 – 2	B12 – 2	A15 returns.	The minor penalty to A6 begins at 4:30.
	3:30				
	4:00	A23 – 2			
	(S)	A6 – 2			
	4:30	Goal			
<b>Coincidental penalties – equal number of players on each team:</b>					
G1	3:00	A15 – 5+2	B12 – 2+2	No player returns.	Teams are at equal strength.
	4:30		Goal		
G2	3:00	A15 – 2+5	B12 – 5	The substitute for A15 returns.	Coincidental major penalties.
	4:30		Goal		
G3	3:00	A15 – 2	B12 – 2	A15 returns.	Coincidental penalties are not put on the clock.
	3:30	A23 – 2			
	4:30	Goal			
G4	3:00	A15 – 2	B12 – 2	A23 returns.	
	3:30	A23 – 2			
	4:30	Goal			
G5	3:00	A15 – 2	B12 – 2	No player returns.	Team A is short-handed, however, it is with a major penalty.
	3:30	A23 – 5			
	4:30	Goal			
G6	3:00	A15 – 2	B12 – 5	A15 returns.	Team A is below the numerical strength of its opponent. Minor penalty to A15 expires on the scoring of the goal.
	3:30	A23 – 5			
	4:30	Goal			
G7	3:00	A15 – 2		A15 returns.	
	3:30	A23 – 2			
	4:30	Goal			



**TABLE 16**  
**(Rule 16 – Minor Penalties)**  
**GOALS SCORED AGAINST A SHORT-HANDED TEAM**

Ex	Time	Team A	Team B	Answer	Remarks
G8	3:00	A15 – 2		A15 returns.	Penalties to A23 and B12 are not on the clock.
	3:30	A23 – 5	B12 – 5		
	4:30		Goal		
G9	3:00	A15 – 5		No player returns.	A15 is serving a major penalty. Penalties to A23 and B12 are not on the clock.
	3:30	A23 – 2	B12 – 2		
	4:30		Goal		
G10	3:00	A15 – 5		A23 returns.	Short-handed by reason of a minor penalty.
	3:30	A23 – 2	B12 – 5		
	4:30		Goal		
G11	3:00	A15 – 2+2	B12 – 5	No player returns.	First minor penalty to A15 is eliminated.
	3:30	A23 – 2			
	4:30		Goal		
G12	3:00	A15 – 2	B12 – 2	The penalty to A6 is not assessed (unless it is a major or match penalty).	
	3:30	A23 – 5			
	(S)	A6 – 2			
	4:30		Goal		
G13	3:00	A15 – 2		A15 returns. A6 returns.	Penalties to A23 and B12 are not on the clock.
	3:30	A23 – 2	B12 – 2		
	4:00	A6 – 2			
	4:30		Goal		
	4:45		Goal		
G14	3:00	A15 – 2		A15 returns.	The minor penalty to A6 begins at 4:30. The penalties to A23 and B12 are not on the clock.
	3:30	A23 – 2	B12 – 2		
	(S)	A6 – 2			
	4:30		Goal		
G15	3:00	A15 – 2+2	B12 – 2	Minor penalty to A15 is eliminated.	Team A would have placed an additional player in the penalty box to serve the extra minor penalty to A15. NOTE: A15's additional minor penalty begins at 3:30 due to the scoring
	3:30		Goal		



**TABLE 16**  
**(Rule 16 – Minor Penalties)**  
**GOALS SCORED AGAINST A SHORT-HANDED TEAM**

Ex	Time	Team A	Team B	Answer	Remarks
					of the goal by Team B, but does not affect the on-ice strength.
<b>Coincident penalties – unequal number of players on each team:</b>					
H1	3:00	A15 – 2 A23 – 2	B12 – 2	Captain's choice.	This choice must be made at the time of assessment of the penalties.
	4:30		Goal		
H2	3:00	A15 – 2 A23 – 5	B12 – 2	No player returns.	The major penalty makes the team short-handed. The penalties to A15 and B12 do not go on the clock.
	4:30		Goal		
H3	3:00	A15 – 2 A23 – 2	B12 – 5	Captain's choice.	The minor penalties end at the same time.
	4:30		Goal		
H4	3:00	A15 – 2 A23 – 5	B12 – 5	A15 returns.	Major penalties are coincidental and do not go on the clock.
	4:30		Goal		
H5	3:00	A15 – 5 A23 – 2	B12 – 2	No player returns.	Coincidental minor penalties. Team A is short-handed by reason of the major penalty. Penalties to A23 and B12 do not go on the clock.
	4:30		Goal		
H6	3:00	A15 – 2+2 A23 – 2	B12 – 2	Captain's choice. The minor penalty to B12 can cancel off with any one of the minor penalties assessed to the two players on Team A.	Depending on the choice made by Team A, A23 may return or the first minor penalty to A15 will end with the scoring of the goal.
	4:30		Goal		
H7	3:00	A15 – 2 A23 – 2+2	B12 – 2	Captain's choice. The minor penalty to B12 can cancel off with any one of the minor penalties assessed to the two players on Team A.	Depending on the choice made by Team A, A15 may return or the first minor penalty to A23 will end with the scoring of the goal.
	4:30		Goal		



**TABLE 16**  
**(Rule 16 – Minor Penalties)**  
**GOALS SCORED AGAINST A SHORT-HANDED TEAM**

Ex	Time	Team A	Team B	Answer	Remarks
H8	3:00	A15 – 2 A23 – 2 A6 – 2	B12 – 2		
	4:00		Goal	Captain's choice.	B12 and one of the minor penalties to Team A (depending on choice) will not go on the clock.
	4:30		Goal	Remaining player returns.	According to the choice made by Team A when the penalties were assessed.
H9	3:00	A15 – 5 A23 – 2 A6 – 2	B12 – 2	Captain's choice.	Coincidental penalty rule applies to B12 and either A23 or A6 (and these penalties would not go on the clock).
	4:30		Goal		
H10	4:00	A15 – 2	B12 – 2	No player returns.	A23's first penalty terminates. A23's second penalty starts.
	4:30	A23 – 2+2			
	5:00		Goal		

**NOTE: Coincident penalties must always be served in their entirety.**

**TABLE 17**  
**(Rule 19 – Coincidental Penalties)**  
**COINCIDENTAL PENALTIES**  
**(all penalties assessed at the same stoppage)**

	Team A	Penalties	Team B	Penalties	On-ice Strength
Example 1	A3	2	B10	2+2	Team B will play one player short-handed for two minutes. Team B must place an additional player to serve the extra minor penalty to B10.
Example 2	A3	2	B10	2+2	Teams play at full strength.
	A5	2+2	B12	2	
Example 3	A3	2+2	B10	2+2	Teams play at full strength.
	A5	5	B12	5	
Example 4	A3	2+5	B10	2	Teams play at full strength
			B12	5	



**TABLE 17**  
**(Rule 19 – Coincidental Penalties)**  
**COINCIDENTAL PENALTIES**  
**(all penalties assessed at the same stoppage)**

	Team A	Penalties	Team B	Penalties	On-ice Strength
Example 5	A3	2+5	B10	2	Team A will play one player short-handed for two minutes. Team A Captain's choice to determine which penalty would go on the penalty time clock. Should A3 be chosen, then an additional team A player must be placed on the penalty bench to serve the minor penalty for A3.
	A5	2	B12	5	
Example 6	A3	2+2	B10	2+2	Team A one player short-handed for five minutes.
	A5	5			
Example 7	A3	2+2	B10	2	Team A Captain's choice to play one player short-handed for four minutes or two players short-handed for two minutes. Should he choose the latter, an additional team A player must be placed on the penalty bench to serve the minor penalty for A3.
	A5	2			
Example 8	A9	2	B2	2+2	Team B will be one player short-handed for two minutes. Team B Captain's choice of which player's time will go on the penalty time clock. If he chooses B2, then team B must place an additional player on the penalty bench to serve B2's minor penalty.
	A24	2	B18	2	
Example 9	A3	5	B5	5	Teams play at full strength.
Example 10	A3	5	B5	5	Team B short-handed for five minutes (Captain's choice).
			B7	5	
Example 11	A3	5	B5	5	Teams play at full strength.
	A4	5	B7	5	
Example 12	A3	5+5	B5	5	Team A short-handed for five minutes. Team A must place an additional player on the penalty bench to serve the extra major penalty.
Example 13	A3	5+5	B5	5	Teams play at full strength.
			B7	5	





**TABLE 17**  
**(Rule 19 – Coincidental Penalties)**  
**COINCIDENTAL PENALTIES**  
**(all penalties assessed at the same stoppage)**

	Team A	Penalties	Team B	Penalties	On-ice Strength
Example 14	A3 A4	5+5 5	B7	5	Team A has the choice to cancel one of the two major penalties assessed to A3 or to simply cancel the one to A4. Should they choose A3, they will require an additional player in the penalty box.
Example 15	A3 A4	5+5 5	B5 B7	5 5	Team A will be short-handed for five minutes. Team choice to cancel majors assessed. Should they choose A3, they will require an additional player in the penalty box.
Example 16	A3	2+5	B7	5	Team A must place another player in the penalty box to serve the additional minor penalty to A3 immediately.
Example 17	A3	2+5	B7	2+5	Teams play at full strength.
Example 18	A3	2+5	B5 B7	5 5	Team A short-handed for two minutes. Team B shorthanded for five minutes (Captain's choice). Team A must place another player in the penalty box to serve the minor penalty.
Example 19	A3	2	B5	5	In the last five minutes of the game or anytime in overtime, the three minute differential will be posted on the penalty clock. Team B will play short-handed for three minutes and it will be served in the same manner as a major penalty.
Example 20	A3	2+2	B5	5	In the last five minutes of the game or anytime in overtime, the one minute differential will be posted on the penalty clock. Team B will play short-handed for one minute and it will be served in the same manner as a major penalty.
Example 21	A3	2+5	B5	2+2+5	Team B will play short-handed for two minutes. Team B will require an additional player in the penalty box to serve the minor penalty.
Example 22	A3 A4	2+5 5	B5 B7	5 5	Team A will play short-handed for two minutes. Team A will require an additional player in the penalty



**TABLE 17**  
**(Rule 19 – Coincidental Penalties)**  
**COINCIDENTAL PENALTIES**  
**(all penalties assessed at the same stoppage)**

	Team A	Penalties	Team B	Penalties	On-ice Strength
					box to serve the minor penalty.
Example 23	A3	2+5	B5	2+5	Team A will be short-handed either one player for four minutes, or two players for two minutes (Captain's choice). Team B will be short-handed for five minutes (Captain's choice).
	A4	2+2+5	B7	5+5	
Example 24	A3	2+5	B5	2+2+5	Team B will be short-handed either one player for seven minutes or two players, one for two minutes and one for five minutes (Captain's choice).
	A4	5	B7	5+5	
Example 25	A3	2+5	B5	5	Team A will be short-handed, either one player for seven minutes, or two players, one for two minutes and one for five minutes (Captain's choice).
	A4	5			
Example 26	A3	2+5+5	B5	2+5	Teams play at full strength.
			B7	5	
Example 27	A5	2	B12	5+5	Teams play at full strength.
	A6	5+5	B13	2	
	A7	5	B14	5	

**TABLE 18**  
**(Rule 69 – Interference on the Goalkeeper)**  
**INTERFERENCE ON THE GOALKEEPER SITUATIONS**

Situation	Result
<b>1. THE GOALKEEPER IS IN THE GOAL CREASE.</b>	
A. An attacking player is standing in the goal crease when the puck enters the crease then crosses the goal line. In no way does he affect the goalkeeper's ability to defend his goal.	Goal is allowed. This is a good goal.
B. An attacking player makes incidental contact with the goalkeeper, however, no goal is scored on the play.	Play continues, no whistle.



**TABLE 18**  
**(Rule 69 – Interference on the Goalkeeper)**  
**INTERFERENCE ON THE GOALKEEPER SITUATIONS**

Situation	Result
C. An attacking player makes incidental contact with the goalkeeper at the same time a goal is scored.	Goal is disallowed. The official in his judgment may call a Minor penalty on the attacking player. The announcement should be, "No goal due to interference with the goalkeeper."
D. An attacking player makes other than incidental contact with the goalkeeper, however, no goal is scored on the play.	A Minor penalty, plus assessment of whatever other penalties may be appropriate up to and including Supplementary Discipline.
E. An attacking player makes other than incidental contact with the goalkeeper at the time a goal is scored.	Goal is disallowed, and a Minor and/or Major penalty, plus assessment of whatever penalties may be appropriate up to and including Supplementary Discipline.
<b>2. THE GOALKEEPER IS OUT OF THE GOAL CREASE.</b>	
A. An attacking player makes incidental contact with the goalkeeper, however, no goal is scored on the play.	Play continues, no whistle.
B. An attacking player makes incidental contact with the goalkeeper at the time a goal is scored.	Goal is allowed.
C. An attacking player makes other than incidental contact with the goalkeeper, however, no goal is scored on the play.	A Minor and/or Major penalty, plus assessment of whatever other penalties may be appropriate up to and including Supplementary Discipline.
D. An attacking player makes other than incidental contact with the goalkeeper at the time a goal is scored.	A Minor and/or Major penalty, plus assessment of whatever other penalties may be appropriate up to and including Supplementary Discipline and the goal is disallowed.
<b>3. A DEFENDING PLAYER PUSHES, SHOVS, OR FOULS AN ATTACKING PLAYER INTO THE GOALKEEPER, WHO IS IN OR OUT OF THE CREASE.</b>	



**TABLE 18**  
**(Rule 69 – Interference on the Goalkeeper)**  
**INTERFERENCE ON THE GOALKEEPER SITUATIONS**

Situation	Result
A. The attacking player, after having made a reasonable effort to avoid contact, makes contact with the goalkeeper at the time a goal is scored.	Goal is allowed.
B. The contact by the attacking player with the goalkeeper is other than incidental and the attacking player, in the judgment of the Referee, did not make a reasonable effort to avoid such contact. However, no goal is scored on the play.	A Minor and/or Major penalty, plus assessment of whatever other penalties may be appropriate up to and including Supplementary Discipline.
C. The contact by the attacking player with the goalkeeper is other than incidental and the attacking player, in the judgment of the Referee, did not make a reasonable effort to avoid such contact at the time a goal is scored.	A Minor and/or Major penalty may be called at the discretion of the Referee plus assessment of whatever other penalties may be appropriate up to and including Supplementary Discipline and the goal is disallowed.
<b>4. BATTLE FOR LOOSE PUCK WITH THE GOALKEEPER WHILE THE GOALKEEPER IS IN OR OUT OF THE GOAL CREESE.</b>	
A. An attacking player makes incidental contact with the goalkeeper while both are attempting to play a loose puck at the time a goal is scored.	Goal is allowed.
B. An attacking player makes other than incidental contact with the goalkeeper while both are attempting to play a loose puck at the time a goal is scored.	A Minor and/or Major penalty, plus assessment of whatever other penalties may be appropriate up to and including Supplementary Discipline and the goal is disallowed.
<b>5. SCREENING SITUATIONS.</b>	
A. An attacking player skates in front of the goalkeeper at the top of the goal crease, at the same time a goal is being scored. The attacking player remains in motion and does not	Goal is allowed. This is a good goal.



**TABLE 18**  
**(Rule 69 – Interference on the Goalkeeper)**  
**INTERFERENCE ON THE GOALKEEPER SITUATIONS**

Situation	Result
maintain a significant position in the crease in front of the goalkeeper.	
B. An attacking player skates in front of the goalkeeper, well inside the crease, at the same time a goal is being scored. The attacking player remains in motion and, in the judgment of the Referee, maintains a significant position in the crease impairing the goalkeeper's ability to defend his goal.	Goal is disallowed. The announcement should be, "No goal due to interference with the goalkeeper."
C. An attacking player skates in front of the goalkeeper, outside the crease, at the same time a goal is being scored. The attacking player remains in motion and impairs the goalkeeper's ability to defend his goal.	Goal is allowed.
D. An attacking player plants himself within the goal crease, as to obstruct the goalkeeper's vision and impair his ability to defend his goal, and a goal is scored.	Goal is disallowed. The announcement should be, "No goal due to interference with the goalkeeper."
E. An attacking player plants himself on the crease line or outside the goal crease, as to obstruct the goalkeeper's vision and impair his ability to defend his goal, and a goal is scored.	Goal is allowed.
<b>6. CROWDING THE GOALKEEPER.</b>	
A. A goalkeeper initiates contact with an attacking player to establish position in the crease and the attacking player vacates the position immediately. No goal is scored on the play.	Play continues, no whistle.
B. A goalkeeper initiates contact with an attacking player to establish position in the crease and the attacking player does not vacate the position, however, no goal is scored on the play. A	Minor penalty. This player runs the risk of "bad things" happening by being in the crease. In this example it is a minor penalty.



**TABLE 18**  
**(Rule 69 – Interference on the Goalkeeper)**  
**INTERFERENCE ON THE GOALKEEPER SITUATIONS**

Situation	Result
possible penalty depends on the Referee's judgment as to the degree of contact and degree of resistance with the attacking player and whether the goalkeeper was truly trying to establish a position.	
C. A goalkeeper initiates contact with an attacking player in the crease to establish position and the attacking player vacates the position immediately at the time a goal is scored. Even though the attacking player vacates his position immediately, the contact impairs the goalkeeper's ability to defend his goal.	Goal is disallowed. The announcement should be, "No goal due to interference with the goalkeeper."
D. A goalkeeper initiates contact with an attacking player to establish position in the crease and the attacking player refuses to give ground at the time a goal is scored.	Goal is disallowed. A Minor penalty is not assessed (loss of goal only). The announcement should be, "No goal due to interference with the goalkeeper."
E. A goalkeeper deliberately initiates contact with an attacking player other than to establish position in the crease, or otherwise acts to make unnecessary contact with the attacking player.	Minor penalty to the goalkeeper (slashing, etc.).
F. A goalkeeper initiates contact with an attacking player to establish position in the crease by using excessive force or acting in a manner which would otherwise warrant a penalty, and the attacking player refuses to give ground at the time a goal is scored.	Coincidental Minors (goalkeeper/attacking player) [In this situation, the Referee would emphatically display to players and the fans that he was calling penalties before the puck entered the net, and thus the play was dead at the time the infractions occurred and thus stated there is no goal.]
G. A goalkeeper initiates contact with an attacking player to establish position in the crease by using excessive force or acting in a manner which would otherwise warrant a penalty, and the attacking player vacates the crease at the time a goal is scored.	A Minor penalty to the goalkeeper and the goal is disallowed. This is an example where the attacking player has prevented the goalkeeper from doing his job by being in the crease. The announcement should be, "No goal due to interference with the goalkeeper (plus the



**TABLE 18**  
**(Rule 69 – Interference on the Goalkeeper)**  
**INTERFERENCE ON THE GOALKEEPER SITUATIONS**

Situation	Result
	announcement of the goalkeeper's penalty)."
H. A goalkeeper initiates contact with an attacking player to establish position in the crease by using excessive force or acting in a manner which would otherwise warrant a penalty and the attacking player vacates the crease, but no goal is scored.	Minor penalty to goalkeeper.
<b>7. CONTACT WITH THE GOALKEEPER.</b>	
A. An attacking player initiates contact with the goalkeeper, inside or outside the goal crease, in a fashion that would otherwise warrant a penalty (e.g. "runs" the goalkeeper).	Appropriate penalty (Minor and/or Major and a Game Misconduct) and subject to additional sanctions as appropriate, pursuant to Rule 33A – Supplementary Discipline.
B. An attacking player is in the crease and makes every effort to vacate the crease and the goalkeeper initiates contact to embellish and draw a penalty. No goal is scored on the play.	This is a dive and a Minor penalty to the goalkeeper (diving).
C. A defensive player directs the puck into his own net while an attacking player initiates contact with the goalkeeper.	Goal is disallowed and a Minor and/or Major penalty, plus assessment of whatever other penalties may be appropriate up to and including Supplementary Discipline to the attacking player.
D. A defensive player directs the puck into his own net while an attacking player is standing in the goal crease. The attacking player does not affect the goalkeeper's ability to make the save.	Goal is allowed.



**TABLE 19**  
**(Rule 84 – Overtime)**  
**PENALTIES IN EFFECT PRIOR TO THE START OF OVERTIME –**  
**REGULAR SEASON**

Ex	Time in 3 <sup>rd</sup> Period	Team A	Team B	Resolve
1	19:10	A5 – 2	B17 – 2	The penalty times remain on the penalty time clock and the teams begin overtime playing three (3) skaters against three (3) skaters.
2	19:10 19:50	A5 – 2 A7 – 2	B17 – 2	The teams would begin the overtime period playing four (4) skaters against three (3) skaters. At the first stoppage of play following the expiration of the penalties to A5 and B17, the on-ice strength would be adjusted from five (5) skaters against four (4) skaters down to four (4) skaters against three (3) skaters.
3	19:10 19:25 19:40	A5 – 2 A7 – 2	B17 – 2	Overtime will begin with the player strength of three (3) skaters for team A and four (4) skaters for team B. Through the normal expiration of penalty times, the penalized players will return to the ice. With continuous play, the potential of reaching an on-ice strength of five (5) on five (5) is a possibility. However, the on-ice strength would be adjusted accordingly at the next stoppage of play.
4	19:10 19:30 19:40	A5 – 2 A7 – 2	A17 – 2 A36 – 2	Overtime will begin with the player strength of three (3) skaters against three (3) skaters. Should there be a stoppage of play following the expiration of A5 and B17's penalties, the on-ice strength shall be adjusted to three (3) skaters against three (3) skaters. This permits the remaining penalties to exit the penalty box and return the teams to four (4) on four (4) status. With continuous play, the potential of reaching an on-ice strength of five (5) on five (5) is a possibility. However, the on-ice strength would be adjusted accordingly at the next stoppage of play.
5	19:10 19:20 19:30	A5 – 2 A7 – 2	B17 – 2	Overtime on-ice strength will begin at three (3) on three (3). Through the normal expiration of penalty times, the penalized players will return to the ice. With continuous play, the potential of reaching an





**TABLE 19**  
**(Rule 84 – Overtime)**  
**PENALTIES IN EFFECT PRIOR TO THE START OF OVERTIME –**  
**REGULAR SEASON**

Ex	Time in 3 <sup>rd</sup> Period	Team A	Team B	Resolve
	19:40		B36 – 2	on-ice strength of five (5) on five (5) is a possibility. However, the on-ice strength would be adjusted accordingly at the next stoppage of play to either four (4) on three (3) or four (4) on four (4), as the situation dictates at that particular stoppage of play.

**TABLE 20**  
**(Rule 84 – Overtime)**  
**PENALTIES ASSESSED IN OVERTIME – REGULAR SEASON**

Time in OT	Team A	Team B	On-ice Strength
0:30	A23 – 2		Team A – 3 skaters Team B – 4 skaters
1:00		B17 – 2	Team A – 3 skaters Team B – 3 skaters
1:30	A7 – 2		Team A – 3 skaters Team B – 4 skaters

Once team A has received their second minor penalty, each team must add one player to their on-ice strength. Should the penalty to A23 expire bringing the on-ice strength back to four (4) on four (4) and there is a subsequent stoppage of play, the on-ice strength must be adjusted down to three (3) on three (3) at this point. However, if there is a stoppage of play once the penalty to B17 has expired (and before A7's expires), the on-ice strength would be adjusted to four (4) on three (3). If there is no stoppage in play until both teams have returned to five skaters each, at the next stoppage of play the on-ice strength would be adjusted back down to four (4) on four (4).

**Rule Number****A**

Abstaining from playing the puck .....	72, 81.2
Abusive language or gestures .....	40, 75, Table 1, Table 12
Abuse of officials .....	<b>40</b> , Table 9, Table 12
- captain or alternate coming off the bench .....	6.1
- game misconduct penalties .....	23.4
- linesmen reporting to referee .....	33.4
- misconduct penalties .....	22.4
- referee reports .....	32.9
- unsportsmanlike conduct .....	40
Action scorer .....	38.2
Adjustment to clothing .....	14.1, 63.2, 65.2
Adjustment to equipment .....	14.1, 63.2, 65.2
After the game – fighting .....	47.9
After the period – fighting .....	47.9
After the original altercation – fighting .....	47.7
Aggressor .....	36.6, <b>47.2</b> , Table 6
Altercation .....	<b>47.3</b> , Table 6, Table 8, Table 10, Table 12, Table 15
- abuse of officials .....	40
- aggressor .....	47.2
- face-off location .....	76.2
- failure to proceed to penalty bench .....	47.19
- game misconduct penalties .....	23.2
- goalkeeper leaving goal crease .....	28.6, 32.9
- instigator .....	47.11, 47.12
- instigator – face shield .....	47.6, 75.2
- jersey .....	47.13, 75.2
- leaving the bench .....	70
- match penalties .....	47.15
- official scorer .....	34.5
- physical abuse of officials .....	41
- referee reports .....	32.9
- roughing .....	51.1
- with a spectator .....	23.7, 32.9
Altered jersey .....	9.1
Alternate captain .....	<b>6.2</b>
- coming off bench to protest .....	40.2
- correct number of players on the ice .....	63.3
- delaying the game .....	63.3
- fails to comply with Referee's direction .....	63.3
- game sheet .....	34.1
- leaving bench to protest .....	40.2
- listed on game sheet .....	34.1
- official report of match .....	34.1
- requesting stick measurement .....	10.5

**Rule Number**

Appointment of officials.....	31
Area of a fight - clearing.....	47.4
Arm pads.....	11.3
Articles thrown on ice – linesmen reporting .....	33.4, 53.3, 75.2, 75.3, Table 1, Table 3
Assist.....	32.5, 34.2, 78.1, 78.3
Assists	
- crediting.....	34.2, 78.3
- public address.....	32.5, 34.2
Attacking zone.....	1.6
- calling of penalties – face-off location.....	15.5
- coming from the bench without a helmet – face-off location.....	9.5
- disallowed goal – goalkeeper interference – face-off location.....	69.5
- face-offs.....	76.2
- goalkeeper interference – face-off location.....	69.5
- hand pass.....	79.3
- injured player – face-off location.....	8.1
- off-side.....	83
- player's bench extending into.....	83.3
- puck out of bounds.....	85.1, 85.5
- refusing to play puck.....	72
Attainable pass.....	81.5
Attempt to injure a manager, coach.....	75.5, Table 12
Attempt to injure an official.....	40.5, 41
Attempt to or deliberate injury.....	21
Attempting to continue a fight.....	47.5
Attire.....	32.1, 33.1
Automatic game misconduct.....	20.4, 23.6, Table 6, Table 7
- aggressor.....	47.2
- boarding.....	42.5
- butt-ending.....	58.5
- charging.....	43.5
- checking from behind.....	44.5
- clipping.....	45.5
- cross-checking.....	59.5
- elbowing.....	46.5
- fighting – after original altercation.....	47.7
- fighting – second instigator in a game.....	47.11
- fighting – third instigator in a season.....	47.11
- fighting – when aggressor.....	47.2
- head-butting.....	48.5
- hooking.....	55.4
- kneeling.....	50.5
- instigator – final five minutes of regulation time.....	47.12
- instigator – second in a game.....	47.11
- instigator – third in a season.....	47.11
- second fight, same stoppage.....	47.7
- second instigator in a game.....	47.11



	<u>Rule Number</u>
- slashing.....	61.5
- spearing.....	62.5
- stick measurement – third violation in season .....	10.5
- third major penalty in a game .....	20.4
- third instigator in a season .....	47.11
Automatic suspension	
- abuse of officials category.....	23.4
- coach or non-playing club personnel involved in altercation.....	47.8
- fighting other than during the periods of the game .....	47.9
- general category.....	23.3
- instigator, aggressor and game misconduct list.....	36.6
- instigator in final five minutes of regulation time .....	47.22
- physical abuse of officials.....	41
- stick infractions, boarding and checking from behind category .....	23.5
- stick measurement – third violation in season .....	10.5
Awarded goal.....	<b>26</b> , Table 14
- covering puck in crease.....	67.5
- displacing goal post.....	63.6
- during penalty shot .....	26.4
- falling on puck in crease.....	67.5
- fouling from behind.....	54.4, 55.6, <b>57.4</b> , 61.7
- gathering puck in crease .....	67.5
- goalkeeper deliberately removing face mask.....	9.5
- handling puck in crease.....	67.5
- holding puck in crease.....	67.5
- illegal substitution .....	68.4, 70.8
- interference from bench.....	56.7
- interference by player illegally entered into game.....	68.4, 70.8
- interference by team member not legally on the ice .....	56.7
- picking up puck in crease .....	67.5
- piling snow or other objects.....	67.5
- shoots equipment .....	53.7
- shoots stick.....	53.7
- throwing equipment .....	53.7
- throwing stick.....	53.7
- tripping.....	57.4

## B

Back of net.....	85.2, 85.5
Banging boards with stick.....	40.2, 40.3, Table 1, Table 9, Table 12
Banging glass in protest of ruling .....	40.2, 40.4
Batting puck.....	39.4, 63.2, 67.1, 67.6, 78.5
Before the game – fighting .....	47.9
Before the period – fighting .....	47.9
Bench.....	<b>3</b>
- bench – penalty (see Penalty bench)	
- bench - players' (see Players' bench)	



	<b><u>Rule Number</u></b>
Bench minor penalty .....	17
- abuse of officials .....	40.3
- delaying the game .....	63.3
- designated player to serve .....	17.1
- distractions during penalty shot .....	25.4
- end of periods .....	86.5
- face-off violation .....	76.4, 76.6, 76.8
- goalkeeper in regular season overtime .....	84.2
- goalkeeper proceeding to players' bench .....	28.6
- illegal substitution .....	68.2
- injured player leaving the ice during play .....	8.1
- interference from the bench .....	56.3
- leaving the bench .....	70.4, 70.5
- line changes .....	82.2, 82.3
- refusing to start play .....	73.2, 73.3
- starting line-up .....	7.2
- start of game and periods .....	86.2
- short-handed .....	16.2
- slow proceeding to face-off location .....	76.6
- throwing equipment .....	53.3
- too many men on the ice .....	74.2
- unsportsmanlike conduct .....	40.3, 75.3
- unsustained complaint regarding legality of a glove .....	12.2
- unsustained request for stick measurement .....	10.5
Biting .....	21, 75.2, Table 8
Blocking glove .....	11.6, 51.3, Table 8, Table 15
Blood .....	8.3
Boarding .....	23.5, 30.1, 42, Table 2, Table 5, Table 7, Table 8
- fines .....	42.6
- game misconduct penalty .....	42.5
- major penalty .....	42.3
- match penalty .....	42.4
- minor penalty .....	42.2
- suspensions .....	42.6
Boards .....	1.3
- banging .....	40, Table 1, Table 9
- boarding .....	42
- charging .....	43.1
- color .....	1.3
- dimensions .....	1.3
- frozen against – puck .....	15.5
- glass .....	1.3
- markings .....	1.3
- puck coming to rest on top of .....	85.1
- puck frozen against .....	15.5
- puck out of bounds .....	85
- restricted area .....	28.8



	<b><u>Rule Number</u></b>
- safety glass.....	1.3
Boot channel.....	11.2
Boot of the pad.....	11.2
Breakaway.....	25.8, 53.6, 56.6, 57.3, 63.5, 68.1, Table 1, Table 13
Breaking stick when requested for measurement.....	10.5
Broken stick.....	10.3, 10.4, 56.2, Table 2
Butt-ending.....	<b>58</b> , Table 4, Table 5, Table 6, Table 8, Table 11
- double-minor penalty.....	15.3, <b>58.2</b>
- fines.....	58.6
- game misconduct penalty.....	58.5
- major penalty.....	58.3
- match penalty.....	58.4
- signal.....	30.2
- suspensions.....	58.6

## C

Calf protectors.....	11.2
Calling of penalties.....	<b>15</b> , Table 1
Calling penalty – goal scored.....	15.2, 15.3, 15.4
Captain.....	<b>6.1</b> , Table 16, Table 17
- alternate captains.....	6.2
- coming off the bench to protest.....	6.1, 40.2
- delayed penalties – penalties expire at the same time.....	27.2
- delaying the game.....	63.3
- designated player – bench minor penalty.....	17.1
- designated player – goalkeeper’s penalties.....	28.1
- designated player – match penalty.....	21.2
- designated player – misconduct penalty to goalkeeper.....	22.2
- designated player – penalty shot.....	25.3, 53.6
- listed on game sheet.....	34.1
- official report of match.....	34.1
- penalties to two players expire at the same time.....	16.2, 27.2, 36.5
- refusing to start play.....	73.2
- requesting stick measurement.....	10.5
Carrying two sticks.....	10.5
Catching glove.....	11.5
Change of players.....	70.2, 81.4, 82
Change of possession.....	13.3
Charging.....	30.3, 42.1, <b>43</b> , Table 2, Table 5, Table 7, Table 8, Table 10
- fines.....	43.6
- game misconduct penalty.....	43.5
- goalkeeper in crease.....	43.1
- major penalty.....	43.3
- match penalty.....	43.4
- minor penalty.....	43.2



	<u>Rule Number</u>
- suspensions .....	43.6
Checking from behind .....	23.5, 30.4, <b>44</b> ,
.....	Table 5, Table 6, Table 8
- fines .....	44.6
- game misconduct penalty .....	44.5
- major penalty .....	44.3
- match penalty .....	44.4
- minor penalty .....	44.2
- suspensions .....	44.6
Chest pad .....	11.3
Choice of ends .....	86.3
Circles – face-off .....	1.9, 76, 86.1, 86.8
Clearing the area of a fight .....	47.4
Clearing the zone .....	<b>83.3</b>
Clipping .....	30.5, <b>45</b> , Table 2, Table 5,
.....	Table 6, Table 8, Table 10
- fines .....	45.6
- game misconduct penalty .....	45.5
- major penalty .....	45.3
- match penalty .....	45.4
- minor penalty .....	45.2
- suspensions .....	45.6
Clock .....	<b>4</b> , 35, 36.5, 39.6, 77.2, 86.2, 86.8
Closing hand on the puck .....	67.2, 79.1
Clothing .....	14.1, 63.2, 65.2
Clothing – adjustment .....	14.1, 63.2, 65.2
Club executive coming onto ice .....	70.10
Coach .....	<b>5.4</b>
- abuse of officials .....	40, Table 12
- abusive language or gestures .....	40, 75, Table 12
- attempt to injure a coach .....	75.5, Table 12
- banging boards .....	40, Table 12
- bench minor penalties .....	17.1
- captain and alternate captains .....	6.1, 6.2, 34.1
- coming onto ice .....	70.5
- deliberate injury of a coach .....	75.5, Table 12
- designated player for bench minor penalties .....	17.1
- designated player for goalkeeper penalties .....	28.1
- designated player for match penalties .....	21.2, 28.5
- distraction during a penalty shot .....	25.4
- eligible players .....	5.1, 34.1
- goalkeeper's penalties .....	28
- interference from bench .....	56.3, Table 12
- involved in altercation .....	47.8
- leaving bench .....	70.5, Table 3
- line change warning .....	76.6, 76.7, 82.2
- line-up .....	34.3
- match penalties .....	21.2, 28.5



	<b>Rule Number</b>
- obscene language or gestures .....	40, 75, Table 12
- penalties .....	Table 1
- penalty shot – distraction during.....	25.4
- physical abuse of officials.....	41
- profane language or gestures .....	40, 75, Table 12
- refusing to start play .....	73.2, 73.3
- shootout – stick measurement .....	10.7
- starting line-up .....	7, 34.3
- stick measurement – shootout .....	10.7
- supplementary discipline .....	29
- throwing objects.....	53.3, 75.3, 75.4, Table 12
- unable to continue – referee, linesman .....	32.11, 33.6
- warning – line change.....	76.6, 76.7, 82.2
Coincidental major penalties .....	19.2, Table 16
Coincidental match penalties .....	19.3
Coincidental minor penalties .....	19.1, Table 16, Table 18
Coincidental penalties .....	16.2, 19, 28.5, ..... Table 16, Table 17, Table 18
Coincidental penalties in overtime .....	19.1
Coincidental penalty rule .....	19.5, Table 16
Coming from bench without helmet during play.....	9.5
Coming off bench to protest.....	40.2
Coming onto ice – club executive .....	70.10
Coming onto ice – coach.....	70.5
Commercial time-out .....	87.1
- light .....	4.1
Commissioner	
- abuse of officials.....	40.7
- altercation with spectator.....	23.7
- appointment of officials.....	31.1
- attempt to injure a coach .....	75.5
- awarded goal – interference.....	56.7
- boarding.....	42.6
- butt-ending.....	58.6
- charging.....	43.6
- checking from behind .....	44.6
- clipping.....	45.6
- club executive coming onto the ice .....	70.10
- coach coming onto the ice.....	70.5
- coach involved in altercation .....	47.8
- coming onto the ice – club executive .....	70.10
- coming onto the ice – coach.....	70.5
- cross-checking.....	59.6
- dangerous equipment – opposing team objection .....	9.6
- deliberate injury of a coach .....	75.5
- elbowing.....	46.6
- end of game / periods.....	32.9, 86.5
- fighting other than during periods of the game.....	47.20



**Rule Number**

- fighting prior to drop of puck .....	47.10
- forfeit of game .....	66.1
- game misconduct penalties .....	23.2, 40.5
- goalkeeper leaving goal crease .....	28.6
- goalkeeper substitution – delay .....	8.2
- goalkeeper’s equipment .....	11.8
- goalkeepers’ sticks .....	10.2
- head-butting .....	48.6
- high-sticking .....	60.6
- hooking .....	55.6
- ineligible player .....	5.2
- interference – awarded goal .....	56.7
- interference – penalty shot .....	56.6
- kicking .....	49.4
- kneeling .....	50.6
- league inspections .....	11.8, 12.5
- leaving goal crease .....	28.6
- leaving the bench .....	70.10
- line-up policy .....	34.3
- match penalties .....	21.3
- obscene gestures / language .....	40.7, 75.7
- officials .....	31.1
- participating in play with two sticks .....	10.5
- penalty shot – interference .....	56.6
- physical abuse of officials .....	41
- pre-game warm-up .....	86.6
- referee reports .....	32.9
- refusing to start play .....	73.2, 73.3
- roughing .....	51.4
- slashing .....	61.7
- slew-footing .....	52.3
- spearing .....	62.6
- spectator .....	23.7
- start of game / periods .....	32.10, 86.7
- supplementary discipline.....	<b>29</b> , 42.6, 43.6, 44.6, 45.6, 46.6, 48.6,
.....	49.4, 50.6, 51.4, 52.3, 53.8, 55.6,
.....	58.6, 59.6, 60.6, 61.7, 62.6, 75.7
- throwing equipment .....	53.8
- throwing object at spectator .....	23.7
- warm-up .....	86.6
Communication .....	34.4, 36.3, 37.2, 39.5
Confirmation of goal at one end prior to goal at other .....	39.6, 78.6
Contact during an icing .....	81.1
Contact inside the goal crease .....	69.3
Contact outside the goal crease .....	69.4
Continuing a fight (attempting to continue) .....	47.5
Control of the puck	
- awarded goals .....	26.1, 57.4



	<b><u>Rule Number</u></b>
- calling of penalties .....	15.1
- injured player .....	8.1
- off-side .....	83.1
- penalty shot .....	25.8, 56.6, 57.3
Correct number of players on the ice .....	63.3
Covering puck in goal crease .....	67.4, 67.5
Crease .....	1.7
- charging goalkeeper in crease .....	43.1
- contact inside .....	69.3
- contact outside .....	69.4
- entering referee's crease .....	40.4, Table 9
- falling on puck .....	67.4, 67.5, Table 13
- freezing puck .....	63.2, 67.4, 67.5, Table 15
- gathering puck .....	67.4, 67.5, Table 13
- goal crease .....	1.7
- goal crease during fight .....	47.4
- goalkeeper in crease – charging .....	43.1
- handling puck .....	67.4, 67.5, Table 13
- holding puck .....	67.4, 67.5, Table 13
- icing .....	81.3
- interference on the goalkeeper .....	69, Table 2, Table 18
- leaving goal crease .....	28.6, 32.9, Table 15
- loose pucks .....	69.6, 78.4
- penalty shot .....	25.2
- picking up puck .....	67.4, 67.5, Table 13
- rebounds .....	69.6
- referee's crease .....	1.7
- referee's crease – entering .....	40.4, Table 9
- remain in goal crease .....	47.4
- stopping play .....	63.2, 67.4, 67.5, Table 15
Crediting assists .....	34.1, 78.3
Crediting goals .....	78.2
Crossbar .....	2.1, 25.2, 60.5, 78.5, 80.3
Cross-checking .....	<b>59</b> , Table 2, Table 5, Table 6, Table 8, Table 11
- fines .....	59.6
- game misconduct penalty .....	59.5
- major penalty .....	59.3
- match penalty .....	59.4
- minor penalty .....	59.2
- signal .....	30.6
- suspensions .....	59.6
Curvature .....	10.1, 10.5

## D

Dangerous equipment .....	9.6, 12.3
- opposing team objection .....	9.6
Defending zone .....	1.6



	<u>Rule Number</u>
- clearing area of a fight – fight in front of benches.....	47.4
- delaying the game.....	63.2
- face-offs .....	76.2
- hand pass.....	79.2
- hand pass – linesman stopping play.....	33.5
- handling puck.....	67.1
- net displaced.....	63.2
- no off-side .....	83.1, 83.2
- puck off official directly into goal .....	76.2
- puck over glass .....	63.2
- puck unplayable .....	85.2
- shooting puck over glass .....	63.2
- throwing equipment.....	53.2, Table 1, Table 13
<b>Deflection</b>	
- disallowed goals.....	78.5
- distinct kicking motion.....	49.2
- during delayed calling of a penalty .....	78.5
- handling puck.....	67.6
- high-sticking the puck .....	80.3
- icing.....	81.1
- kicking the puck.....	49.2
- off an official .....	39.4, 76.2, 78.5, 81.1, 83.2, 85.4
- off body into goal.....	78.5
- off-side .....	83.2
- puck out of bounds.....	85.4
- rebound in the crease .....	69.6
- rebound on a penalty shot .....	25.2
<b>Delayed calling of a penalty.....</b>	<b>78.5</b>
- no goal .....	78.5
<b>Delayed calling of a penalty shot and goal scored .....</b>	<b>15.4</b>
<b>Delayed off-side .....</b>	<b>30.9, 56.2, 83.3</b>
<b>Delayed penalty .....</b>	<b>19.1, 27, 30.8, 84.2, Table 16</b>
<b>Delaying the game .....</b>	<b>63, Table 2, Table 3, Table 14</b>
- adjustment of equipment.....	65.2
- awarded goal.....	63.6
- bench minor penalty.....	63.3
- covering puck.....	67.2, 67.3
- dangerous equipment .....	9.6
- displacing goal post .....	63.2
- dropping puck on netting.....	85.6
- end of period .....	86.5
- face-off violation.....	76.6
- falling on puck in crease .....	63.5, 67.4, 67.5
- freezing puck unnecessarily.....	67.3
- goalkeeper deliberately removing face mask .....	9.5
- goalkeeper playing puck in restricted area .....	28.8
- improper line change .....	82.2
- infractions.....	63.7



	<b><u>Rule Number</u></b>
- line change .....	82.3
- minor penalty .....	63.2
- objects thrown on ice .....	63.4
- penalty shot .....	63.5
- playing puck in restricted area .....	28.8
- protective equipment .....	9.5
- puck dropped on goal netting .....	85.6
- puck over glass .....	63.2
- refusing to start play .....	73.2, 73.3
- restricted area .....	28.8
- signal .....	30.9
- slow proceeding to face-off location .....	76.6
- start of game .....	86.2
- start of period .....	86.2
- unnecessary stoppage of play .....	67.3
- unsustained request of opponent's equipment .....	12.2
- warm-up during time-out .....	87.1
Deliberate illegal substitution .....	68.6, 74.4, Table 3, Table 13
Deliberate injury .....	21
Deliberate injury of a manager, coach .....	75.5, Table 12
Deliberately applying physical force against an official .....	40.5, 41
Deliberately breaking stick .....	10.5, Table 9
Designated player	
- bench minor penalty .....	17.1
- goalkeeper penalty .....	28
- match penalty .....	21.2, 28.5
- penalty shot .....	25.3
Devices – signal and timing .....	4, 35.4, 36.5, 39.6
Diagrams	
- Approved Goal Frame .....	page v
- catching glove – goalkeeper's .....	11.5
- Detail of Goal Crease .....	page iv
- Dimensions of Rink Surface .....	page iv
- Face-off Configuration .....	page v
- Goal Crease .....	page iv
- Goal Frame .....	page v
- goalkeeper's catching glove .....	11.5
- goalkeeper's jersey .....	9.4
- goalkeeper's stick .....	10.2
- jersey – goalkeeper .....	9.4
- jersey – player .....	9.3
- Official Dimensions of Rink Surface .....	page iv
- player's jersey .....	9.3
- player's stick .....	10.1
- Restricted Area .....	page iv
- Rink Dimensions .....	page iv
- stick – goalkeeper's .....	10.2
- stick – players' .....	10.1

**Rule Number**

- tape measure .....	11.5
Dimensions .....	1.2, 3, 10.1, 10.2, 11, 13.1
Disallowed goals .....	78.5
- batting puck .....	39.4, 67.6, 78.5
- confirmation of goal at one end prior to goal at other .....	39.6, 78.6
- deflected off official .....	39.4, 76.2, 78.5, 85.4
- delayed calling of a penalty .....	78.5
- delayed off-side .....	83.4
- distinct kicking motion .....	39.4, 49.2, 78.5
- goalkeeper pushed into net together with puck .....	69.6, 78.5
- high-sticking the puck .....	78.5, 80.3
- illegal substitution .....	68.5, 78.5
- interference on the goalkeeper .....	69, 78.5
- kicking .....	39.4, 49.2, 78.5
- leaving the penalty bench .....	68.5, 70.4, 78.5
- linesman reporting foul that occurred prior to goal .....	33.4, 78.5
- net dislodged .....	63.2, 78.5
- off-side .....	83.4
- play was stopped .....	32.2, 78.5, 83.4
- public address .....	32.5, 39.2, 78.5
- through goal netting .....	39.4
- under goal frame .....	39.4
- video goal judge .....	39.2
- video review .....	78.5
- whistle had blown .....	32.2, 78.5, 83.4
Discarded stick or other equipment .....	53.2
Discipline – supplementary .....	<b>29</b> , Table 18
- abuse of officials .....	40.6, 40.7
- attempt to injure a team official .....	75.5
- boarding .....	42.6
- butt-ending .....	58.6
- charging .....	43.6
- checking from behind .....	44.6
- clipping .....	45.6
- cross-checking .....	59.6
- diving .....	64.3
- elbowing .....	46.6
- embellishment .....	64.3
- fighting .....	47.10, 47.20
- game misconduct penalties .....	23.2
- head-butting .....	48.6
- high-sticking .....	60.6
- hooking .....	55.6
- interference from the bench .....	56.2
- interference on the goalkeeper .....	69.7
- kicking .....	49.4
- kneeling .....	50.6
- leaving the bench .....	70.2



	<b><u>Rule Number</u></b>
- match penalties .....	21.2
- physical abuse of officials.....	41.6
- roughing.....	51.4
- slashing.....	61.7
- slew-footing.....	52.3
- spearing .....	62.6
- throwing equipment .....	53.8
- unsportsmanlike conduct.....	75.5, 75.6, 75.7
Displacing goal post .....	63.2, 63.5, 63.6
Disputes	
- clock.....	32.2, 35.7, 39.6
- the rulings of an official.....	40.1, Table 12
- expiration of penalties.....	32.2, 36.1
- final decision .....	32.2
- referee .....	32
- penalties .....	32.2, 36.1
- time .....	32.2, 35.7, 39.6
- unsportsmanlike conduct.....	40.1, Table 12
Distinct kicking motion.....	39.4, 49.2, 78.5
Distracting goalkeeper during penalty shot.....	25.4
Distracting player during penalty shot.....	25.4
Diving.....	64
- fines .....	64.3
- minor penalty .....	64.2
- suspensions.....	64.3
Division of ice surface .....	1.6
Double-minor penalty .....	<b>18</b> , Table 4, Table 16
- butt-ending.....	58.2
- disallowed goals .....	78.5
- foul resulting in a penalty shot.....	25.6
- goal scored .....	15.3
- head-butting.....	48.2
- high-sticking.....	60.3
- last five minutes and overtime.....	19.4
- linesman reporting high-stick causing injury .....	33.4, 78.5
- spearing.....	62.2
Drop of puck – fighting prior to .....	47.10

## E

Elbow pads .....	9.5, 12.3
Elbowing .....	30.10, <b>46</b> , Table 2
.....	Table 5, Table 7, Table 8, Table 10
- fines .....	46.6
- game misconduct penalty.....	46.5
- major penalty .....	46.3
- match penalty .....	46.4
- minor penalty .....	46.2



	<b><u>Rule Number</u></b>
- suspensions .....	46.6
Eligibility for shootout .....	84.4
Eligible player .....	5.1, 10.7, 34.1
Embellishment .....	64
Emergency recall – goalkeeper .....	5.3, 11.8
Encroachment .....	33.5, 76.5, 76.6
End of game .....	32.10, 86.5
- fighting .....	47.9
End of period .....	4, 86.5, Table 3
- fighting .....	47.9
Ends – choice of .....	86.3
Entering referee’s crease .....	40.4, Table 9
Equipment .....	<b>65</b> , Section 3, Table 2, Table 9, Table 15
- adjustment of equipment .....	14.1, 63.2, 65.2
- blood stained .....	8.3
- dangerous equipment .....	9.6, 12.3
- goalkeeper’s equipment .....	11
- goalkeeper’s equipment repairs .....	28.6
- goalkeeper’s jersey .....	9.4
- illegal equipment .....	12.1
- jersey .....	9
- kicking equipment .....	49.2
- linesmen equipment .....	33.1
- minor penalty .....	65.2
- numbers .....	9.2
- penalty timekeeper equipment .....	36.2
- player’s jersey .....	9.3
- preventing opponent from retrieving equipment .....	56.2
- protective equipment .....	9.5
- puck .....	13
- referees’ equipment .....	32.1
- retrieving equipment after a fight .....	47.19
- sticks .....	10
- throwing equipment .....	53
- throwing equipment at an official .....	41.4
- throwing equipment out of playing area .....	40.4, 75.2, 75.4, 75.5
- uniform .....	9.1
- video goal judge equipment .....	39.5
Event summary .....	38.3
Exhibition games .....	29.2
Expiration of penalties .....	32.2, 36.1
Extra attacker .....	Table 14
- awarded goals .....	26.3
- goalkeeper in regular season overtime .....	74.5, 84.2
- goalkeeper on an icing .....	81.4
- line change on icing .....	82.1
- illegal substitution .....	74
- overtime – regular season .....	74.5, 84.2

**Rule Number**

- premature substitution.....	71.1
Eye gouging.....	21, Table 8

**F**

Face masks .....	11.7
Face protection.....	47.6, 75.2
Face-off .....	<b>76</b> , Table 2
- abstaining from playing puck.....	72.1
- calling of penalties .....	15.5, 76.2
- circles.....	1, 76, 86.1
- false .....	35.7, 39.6
- fighting prior to.....	47.10, 70.2
- five second limit.....	76.3
- goalkeeper losing mask.....	9.5
- hand pass .....	79.3
- high-sticking opponent during face-off .....	60.1
- high-sticking the puck .....	80.2
- icing .....	81.2
- injured players .....	8.1, 76.2
- interference with goalkeeper .....	69.5
- linesmen .....	33.2
- location after penalty .....	76.2
- off-side .....	83.5
- objects thrown on ice.....	63.4
- penalty shot .....	25.5
- player losing helmet.....	9.5
- premature substitution.....	71.1
- procedure.....	76.3
- puck out of bounds .....	63.2, 85.1
- puck unplayable.....	85.2
- puck out of sight .....	85.3
- puck striking official .....	85.4
- referees.....	32.3
- refusing to play puck.....	72
- responsibility .....	32.3, 33.2, 76.1
- spots .....	1.9, 8.1, 9.5, 25.2, 30.18, 69.5
.....	71.1, 72, 76, 80.2, 81.2, 83.5, 85.5
- start of game.....	86.1
- start of periods.....	86.1
- verification of time.....	35.7, 39.6
- violations.....	76.6, 82.1, 87.1, Table 2
Facial injury protection .....	9.6
Fake an injury.....	64.1
Failure to comply with referee's direction.....	63.3
Failure to place player on penalty bench – major penalty .....	20.3
Failure to proceed directly to penalty bench .....	47.19
Fair play.....	12.4



**Rule Number**

Falling on puck in crease .....	67.4, 67.5, Table 13
Fans throwing objects on ice .....	63.4
Feign an injury .....	64.1
Fighting .....	<b>47</b> , 86.6, Table 5, Table 6
.....	Table 9, Table 10, Table 12
- aggressor .....	47.2, 47.17
- after the original altercation.....	47.7
- altercation.....	47.3
- clearing the area .....	47.4, 47.18
- continuing a fight (attempting to continue).....	47.5
- face protection.....	47.6
- failure to proceed to penalty bench.....	47.19
- fines.....	47.17, 47.18, 47.19, 47.20, 47.21, 47.22
- inciting an opponent.....	75.4
- instigator.....	47.11, 47.12, 47.21, 47.22
- jerseys.....	47.13
- major penalty.....	47.14
- match penalty.....	47.15
- off the playing surface.....	47.8
- other than during the periods of the game.....	47.9, 47.20
- prior to the drop of the puck.....	47.10
- second instigator in game.....	47.11
- suspensions .....	47.17, 47.18, 47.19, 47.20, 47.21, 47.22
- third instigator in season.....	47.11
- third man in .....	47.16
Final decision .....	32.2
Final five minutes – instigator.....	47.12
Fines	
- aggressor .....	47.17
- boarding .....	42.6
- butt-ending .....	58.6
- charging.....	43.6
- checking from behind.....	44.6
- clearing the area of a fight.....	47.18
- clipping .....	45.6
- cross-checking .....	59.6
- diving .....	64.3
- elbowing .....	46.6
- embellishment .....	64.3
- failure to proceed directly to penalty bench .....	47.19
- fighting other than during the periods of the game .....	47.20
- goalkeeper's equipment.....	11.8
- head-butting .....	48.6
- high-sticking .....	60.6
- hooking.....	55.6
- illegal stick.....	10.5, 10.7
- instigator.....	47.21
- instigator in final five minutes.....	47.22



	<b><u>Rule Number</u></b>
- interference on the goalkeeper .....	69.7
- kicking .....	49.4
- kneeling .....	50.6
- leaving the bench .....	70.10
- major penalties .....	20.5
- misconduct penalties .....	22.5
- game misconduct penalties .....	23.3, 22.4, 22.5, 28.2, 28.3, 28.4, 28.6
- refusing to start play .....	73.2, 73.3
- roughing .....	51.4
- slashing .....	61.7
- slew-footing .....	52.3
- spearing .....	62.6
- start of game .....	86.7
- supplementary discipline .....	29
- throwing equipment .....	53.8
- unsustained request for stick measurement .....	10.5
- video review .....	39.2
Flexible pegs .....	2.1, 63.6, 78.5
Flooding the ice .....	1.1
Forfeit of game .....	66, 73.2, 73.3
Foul resulting in penalty shot .....	25.8
Fouling from behind .....	25.8, 57.3
Freezing the puck (frozen puck) .....	Table 15
- back of net .....	85.2
- between opposing players .....	85.2
- delaying the game .....	63.2
- face-off location – calling of penalties .....	15.5, 76.2
- puck unplayable .....	85.2
- unnecessarily .....	67.3

## G

Game	
- end of .....	32.10
- forfeit of .....	66, 73.2, 73.3
- start of .....	32.10, 86.1
Game Flow .....	Section 10
Game misconduct – automatic .....	20.4, 23.6, 47.7, 47.11
.....	59.5, Table 6, Table 7
Game misconduct penalty .....	23, Table 12
- abuse of officials .....	23.4, 40.5
- attempt to injure a team official .....	75.5
- boarding .....	42.5
- butt-ending .....	58.5
- captain coming off the bench .....	6.1
- charging .....	43.5
- checking from behind .....	44.5
- clipping .....	45.5



	<b><u>Rule Number</u></b>
- cross-checking .....	59.5
- elbowing .....	46.5
- fighting .....	47
- general category .....	23.3, Table 10
- goalkeeper .....	28.4
- head-butting .....	48.5
- hooking .....	55.4
- interference .....	56.5
- interfering with a spectator .....	23.7
- kneeling .....	50.5
- leaving the bench .....	70.6
- penalty timekeeper .....	36.1, 36.6
- physical abuse of officials .....	41.1
- post-game verbal abuse .....	23.7
- protective equipment .....	9.5
- racial taunts or slurs .....	23.7
- refusing to start play .....	73.2
- request for review / rescind .....	23.2
- slashing .....	61.5
- spearing .....	62.5
- spitting .....	23.7
- stick-related category .....	23.5, Table 11
- striking a spectator .....	23.7
- throwing equipment .....	53.4
- unsportsmanlike conduct .....	75.5
- verbal abuse .....	23.7
- video review .....	39.2
Game sheet .....	34.1
Game summary .....	38.3
Game time clock .....	4
Game timekeeper .....	<b>35</b>
- delays .....	77.3, 86.4
- game timing .....	77.1
- interfering with .....	40.3
- intermission timing .....	35.2, 77.2
- official scorer – time of goals .....	34.2
- overtime .....	35.3, 84.1, 84.5
- pre-game warm-up .....	86.6
- public address – one minute remaining .....	35.1
- referee duties .....	32.6
- signal devices .....	35.4
- start of game .....	86.6
- start of periods .....	35.5, 77.2, 86.1
- television .....	35.6
- time-outs .....	87.1
- verification of time .....	35.7, 39.6
- warm-up .....	86.6
Game timing .....	77.1



	<u>Rule Number</u>
Games – exhibition.....	29.2
Gathering puck in crease .....	67.4, 67.5, Table 13, Table 14
General category .....	23.3, Table 10
General duties	
- game timekeeper .....	35.1
- goal judge .....	37.1
- linesmen .....	33.3
- official scorer .....	34.1
- penalty timekeeper .....	36.1
- real time scorers .....	38.1
- referees.....	32.4
- video goal judge .....	39.1
Glass	
- banging glass .....	40.2, 40.4
- broken glass – face-off location.....	85.1
- delay of game .....	63.2
- dimensions.....	1.3
- face-off location – broken glass.....	85.1
- face-off location – off-side .....	83.5
- height.....	1.3
- off-side – face-off location .....	83.5
- penalty bench .....	3.2
- players' benches.....	3.1
- puck out of bounds .....	85.1
Glove .....	12.2, Table 8, Table 15
- batting into net .....	67.6
- blocking.....	11.6, 51.3, Table 8, Table 15
- catching .....	11.5
- deflection into net .....	67.6
- disallowed goal .....	49.2, 67.6
- equipment.....	65.2
- illegal equipment.....	12.1
- instigator criteria .....	47.11
- kicking glove .....	49.2
- match penalty .....	51.3
- palm removed or cut.....	12.2
- protective equipment .....	9.5
- puck out of bounds .....	85.1
- roughing.....	51.1
Goal.....	<b>78</b>
- awarded.....	<b>26</b> , Table 14
- awarded – falling on puck.....	67.5
- awarded – fouled from behind.....	54.4, 55.6, <b>57.4</b> , 61.7
- awarded – gathering puck .....	67.5
- awarded – goal displaced.....	63.6
- awarded – holding puck.....	67.5
- awarded – illegal player.....	56.7, 68.4, 70.8
- awarded – interference from bench.....	56.7



	<b><u>Rule Number</u></b>
- awarded – picking up puck .....	67.5
- awarded – piling snow .....	67.5
- awarded – throwing equipment.....	53.7
- crediting.....	78.2
- disputed.....	39.1
- disallowed .....	39.4, 78.5
- disallowed – batting puck.....	67.6
- disallowed - high-sticking .....	60.5, 80.3
- disallowed – illegal player .....	5.2, 68.5, 70.9
- disallowed – ineligible player .....	5.2
- disallowed – kicking .....	49.2
- disallowed – leaving bench .....	68.5, 70.9
- disallowed – off an official .....	78.5
- disallowed – off-side .....	83.4
- light.....	4.1
- official scorer .....	34.1
- public address .....	32.5, 34.2, 39.2
- referee .....	32.5
- scored – double-minor penalty .....	15.3
- scored – minor penalty.....	15.2
- scored – minor and misconduct penalty .....	22.3
- scored – overtime.....	84.1
- scored – short-handed team.....	15.4
- scored – signal .....	30.11
- throwing equipment.....	53.7
- video review .....	39.2, 78.6
Goal crease (see Crease)	
Goal frame .....	1.7, 2.2
Goal judge.....	<b>37</b>
Goal pegs.....	2.1, 63.6, 78.5
Goal posts .....	<b>2</b>
- awarded goal.....	63.6
- displacing .....	63.2, 63.5, 63.6
- goal crease.....	1.7
- goal frame .....	1.7, 2.2
- goal judge.....	37.1
- penalty shot.....	63.5
- rebound off post on penalty shot .....	25.2
- scoring a goal.....	78.4
Goals scored against a short-handed team.....	Table 16
Goalkeeper	
- back-up (see also substitute).....	11.8
- charging in crease.....	43.1
- deliberately removing face mask .....	9.5
- during the course of a penalty shot.....	25.2, 25.4
- equipment .....	5.3, 11, 14.1, 28.6, 63.2, 65
- handling puck.....	67.3
- icing.....	81.3



	<u>Rule Number</u>
- incapacitated .....	5.3
- injured .....	5.3, 8.2
- interference .....	69
- jersey .....	9.4
- leaving goal crease .....	28.6, 32.9
- losing helmet and/or mask .....	9.5
- overtime – regular season .....	74.5, 84.1, 84.2
- penalties .....	<b>28</b> , 36.3, Table 15
- player using goalkeeper's stick .....	10.3
- player's stick – goalkeeper using .....	10.4
- playing puck over center red line .....	28.7
- premature substitution .....	71.1
- proceeding to players' bench .....	28.6
- pushed into net together with puck .....	69.6, 78.5
- restricted area .....	1.8, 28.8, Table 15
- resuming position .....	8.2
- shootout .....	84.4
- stick .....	10.2, 11.1, 49.2
- substitute .....	5.3, 25.2
- substitution .....	8.2, 34.1
- third .....	5.3
- uniform .....	9.4, 9.5
- warm-up .....	5.3, 8.2, 86.8, 87
Gouging – eye .....	21.1, Table 8
Grabbing face mask .....	75.2, Table 8
 <b>H</b> 	
Hair pulling .....	75.2, Table 8
Hand pass .....	67.1, <b>79</b>
- abstains from playing the puck .....	72.2
- advantage gained .....	67.1, 79.1
- linesman stopping play .....	33.5
- refusing to play puck .....	72.2
- signal .....	30.12
Handling puck .....	67
- awarded goal .....	67.5
- delaying the game .....	63.2
- disallowed goal .....	67.6
- hand pass .....	79
- in crease .....	67, Table 13
- minor penalty – goalkeeper .....	67.3
- minor penalty – player .....	67.2
- penalty shot .....	67.4
Hash marks (restraining lines) .....	1.9, 76.5
Head-butting .....	15.3, 30.2, <b>48</b> , Table 4, Table 5, Table 6, Table 8, Table 10
- double-minor penalty .....	48.2



	<u>Rule Number</u>
- fines .....	48.6
- game misconduct penalty .....	48.5
- major penalty .....	48.3
- match penalty .....	48.4
- suspensions .....	48.6
Helmet .....	9.5
Heel of the stick .....	10.1
High-sticking .....	<b>60, 80</b> , Table 2, Table 4, Table 8
- abstaining from playing puck .....	72.3
- contact off a face-off .....	60.1
- cradling the puck (like lacrosse) .....	25.2, 80.1
- disallowed goal .....	39.4, 60.5, 78.5, 80.3
- double-minor penalty .....	60.3
- double-minor penalty – goal scored .....	15.3
- double-minor penalty – linesman reporting .....	33.4
- fines .....	60.6
- goals .....	60.5
- match penalty .....	60.4
- minor penalty .....	60.2
- puck .....	33.5, <b>80</b>
- refusing to play puck .....	72.3
- signal .....	30.14
- suspensions .....	60.6
- video review .....	39.4
Holding .....	<b>54</b> , Table 2
- awarded goal .....	54.4
- interference .....	56.1
- minor penalty .....	54.2
- penalty shot .....	54.3
- restrain .....	56.1
- signal .....	30.15
- stick .....	54.2, Table 2
- stick – signal .....	30.16
Holding puck in crease .....	67.4, 67.5, Table 13
Hooking .....	<b>55</b> , Table 2, Table 5, Table 6, Table 11
- awarded goal .....	55.6
- fines .....	55.7
- game misconduct penalty .....	55.4
- interference .....	56.1
- major penalty .....	55.3
- minor penalty .....	55.2
- penalty shot .....	55.5
- restrain .....	56.1
- signal .....	30.17
- suspensions .....	55.7
Human factor .....	32.2

**Rule Number****I**

Ice surface .....	1.1
- division of .....	1.6
- injured player .....	8.1
- leaving the penalty bench .....	70.4
- proceeding to dressing room .....	70.3
- stick measurement .....	10.5
- too many men on the ice .....	74.1
Icing .....	81
- abstaining from playing puck .....	72.4, 81.2
- attainable pass .....	81.5
- back of net .....	81.5
- contact .....	81.1
- deflections in the neutral zone .....	81.5
- directly off the face-off .....	81.5
- dislodging puck from back of net .....	81.5
- error – face-off location .....	81.2
- face-off location .....	81.2
- goalkeeper .....	81.3
- line change .....	81.4, 82.1
- linesman stopping play .....	33.5
- no icing .....	81.5
- numerical strength .....	81.6
- penalty – non-offending team – face-off location .....	15.5
- puck striking official .....	81.1, 85.4
- rebound off defending player .....	81.5
- receivable pass .....	81.5
- refusing to play puck .....	72.4, 81.2
- short-handed .....	81.6
- signal .....	30.18
- unnecessary contact .....	42.1
Illegal equipment .....	11.8, 12, Table 2, Table 15
Illegal puck .....	13.3, 56.2
Illegal stick – remain at penalty bench .....	10.5
Illegal substitution .....	68, Table 3, Table 13
- awarded goal .....	68.4, 70.8
- bench minor penalty .....	68.2
- deliberate .....	68.6, 74.4
- disallowed goal .....	68.5, 70.9, 78.5
- failure to put substitute in for major penalty .....	20.2, 68.2
- goalkeeper in regular season overtime .....	74.5
- leaving the penalty bench .....	68.5, 70.4, 74.3
- leaving the players' bench .....	68.5, 70.3
- major penalty .....	20.3, 68.2
- overtime – regular season – goalkeeper .....	74.5
- penalty shot .....	68.3, 70.7
- regular season overtime – goalkeeper .....	74.5





	<b><u>Rule Number</u></b>
- too many men on the ice.....	74
Impede .....	54.1, 55.2, 56.1, 56.2
Improper line change .....	82.2
Improper starting line-up .....	7.2
Incapacitated goalkeeper.....	5.3
Inciting an opponent.....	75.4, Table 9, Table 10
Ineligible player .....	5.2, 33.5, 70.4, 74.3, 78.5, 84.2
Infractions	
- abuse of officials .....	40
- awarded goals.....	26, Table 14
- bench minor penalties.....	17, Table 3
- calling of penalties .....	15
- delaying the game.....	63
- double-minor penalties.....	18, Table 4
- game misconduct penalties .....	23, Table 12
- goalkeepers.....	28, Table 15
- icing.....	81
- interference on the goalkeeper .....	69, Table 18
- major penalties.....	20, Table 5
- match penalties .....	21, Table 8
- minor penalties.....	16, Table 2
- misconduct penalties .....	22, Table 9
- off-side .....	83
- penalty shot.....	25, Table 13
- referee general duties .....	32.4
- unique to goalkeepers.....	28, Table 15
Injured goalkeeper .....	5.3, 8.2
Injured player .....	8.1
- attending to .....	70.5
- dangerous equipment .....	9.6
- face-off location.....	8.1, 76.2
- leaving the ice .....	8.1
- icing.....	81.4, 82.1
- major penalty - serving.....	68.2
- penalized player.....	8.1, 68.1
- serious injury .....	8.1
- stopping play.....	8.1
- substitute for.....	8.1
Injury .....	8, Table 7, Table 8
- aggressor .....	47.2
- attempt to injure .....	21.1, Table 8
- attempt to injure a Manager, Coach .....	75.5
- attempt to injure an official .....	40.5, 41
- biting.....	21.1, Table 8
- blocking glove .....	51.3, Table 8
- blood.....	8.3
- boarding .....	42.4, 42.5, Table 7, Table 8
- boards .....	1.3

**Rule Number**

- butt-ending.....	58.4, Table 8
- charging.....	43.4, 43.5, Table 7, Table 8
- checking from behind.....	44.4, Table 8
- clipping.....	45.3, 45.4, Table 8
- cross-checking.....	59.4, Table 8
- dangerous equipment.....	9.6
- delays due to.....	34.1
- deliberate injury.....	21.1, Table 8
- deliberate injury of a Manager, Coach.....	75.5
- designated player for penalty shot – injury to.....	25.3
- deliberately applies physical force against an official.....	40.5, 41
- elbowing.....	46.4, 46.5, Table 7, Table 8
- face – injury to.....	20.4, Table 7
- facial injury protection.....	9.6
- feigns an injury.....	64.1
- goalkeeper proceeding to players' bench.....	28.6
- goalkeeper resuming position.....	8.2
- grabbing of the face mask.....	21.1, Table 8
- hair pulling.....	21.1, Table 8
- head-butting.....	48.4, Table 8
- head – injury to.....	20.4
- high-sticking.....	60.3, 60.4, Table 8
- hooking.....	55.3, 55.4
- icing – line change.....	81.4, 82.1
- injured goalkeeper.....	8.2
- injured players.....	8.1
- intent to injure an official.....	41
- kicking.....	49.3, Table 8
- kneeling.....	50.4, Table 8
- leaving the ice during play.....	8.1, 74.1
- line change – icing.....	81.4, 82.1
- linesmen.....	33.5, 33.6
- major penalties.....	20.3
- match penalties.....	21.1, Table 8
- penalized player.....	8.1
- penalty shot – injury to designated player.....	25.3
- punch causing injury.....	47.15, 51.3, Table 8
- referees.....	32.11
- slashing.....	61.3, 61.4, Table 8
- spearing.....	62.4, Table 8
- stopping play.....	8.1, 8.2
- striking an official.....	41
- substitution for injured player.....	8.1
- tape on hands.....	47.15, Table 8
- threaten to injure an official.....	41.4
- throwing stick / equipment.....	53.5, Table 8
- warm-up for substitute goalkeeper.....	8.2
- wearing tape on hands.....	47.15, Table 8



	<b><u>Rule Number</u></b>
Inner knee padding .....	11.2
Inner risers .....	11.2
Inspections .....	11.8, 12.5
Instigator .....	<b>47.11</b> , Table 2, Table 6
- face shield .....	75.2
- final five minutes of regulation or in overtime .....	47.12
- instigator, aggressor and game misconduct list .....	36.6
- leaving penalty bench .....	70.4
- referee reports.....	32.9
- request for review/rescind.....	47.11
- second in game.....	47.11
- third in season.....	47.11
- visor.....	75.2
- wearing a face shield .....	47, 75.2
Instigator, aggressor and game misconduct list .....	36.6
Intent to injure an official .....	41
Intentional off-side.....	76.2, 83.6
Interference .....	56
- awarded goal.....	56.7, Table 1
- bench minor penalty.....	56.3
- breakaway.....	56.6, 56.7, Table 1
- body position.....	56.1
- broken stick.....	53.2, 56.2
- discarded stick or other equipment.....	53.2, 56.2
- free hand.....	56.1
- from players' bench.....	56.2, 56.3, 74, Table 3
- game misconduct penalty .....	56.5
- goalkeeper – on the .....	<b>69</b> , 78.5, Table 2, Table 18
- illegally entered the game .....	68.3, 68.4, 70
- major penalty.....	56.4
- minor penalty.....	56.2
- official – with an.....	40.3, Table 1
- penalty shot.....	56.6, Table 1
- pick.....	56.1
- play in progress.....	56.2, Table 1
- possession of the puck .....	56.1
- restrain .....	56.1
- signal.....	30.19
- spectators – by/with .....	23.7, 33.5, 53.6
- stick (use of).....	56.1
Interference on the goalkeeper .....	69
- contact inside the crease .....	69.3
- contact outside the crease .....	69.4
- face-off location.....	69.5
- fines.....	69.7
- loose pucks .....	69.6
- penalty.....	69.2
- rebounds .....	69.6



	<b><u>Rule Number</u></b>
- suspensions.....	69.7
Interference on the goalkeeper situations.....	Table 18
Interfering or distracting from bench on penalty shot.....	25.4
Interfering with an official.....	40.3, Table 1
Interfering with game timekeeper.....	40.3
Intermission.....	32.10, 35.2, 77.2, 84.5, 86.1
- timing.....	35.2, <b>77.2</b>
Intervening in an altercation (fight).....	47.16, Table 12

**J**

Jersey.....	Table 10
- altered.....	9.1, 9.3, 9.4, 9.5
- during fight.....	47.13, Table 10
- goalkeeper.....	9.4
- modified.....	47.13, 75.2
- player.....	9.3
- removing.....	47.13, 75.2
- torn.....	9.5

**K**

Kicking.....	49
- deflections.....	49.2
- disallowed goals.....	78.5
- distinct kicking motion.....	39.4, 49.2
- equipment.....	49.2
- fines.....	49.4
- glove.....	49.2
- goals.....	49.2
- match penalty.....	21.1, 49.3, Table 8
- puck.....	49.2
- suspensions.....	49.4
- video goal judge.....	39.4
Kick plate.....	1.3
Kneeing.....	30.21, <b>50</b> , Table 2, Table 5, Table 6, Table 8, Table 10
- fines.....	50.6
- game misconduct penalty.....	50.4
- major penalty.....	50.3
- match penalty.....	50.4
- minor penalty.....	50.2
- suspensions.....	50.6
Knee strap pad.....	11.2

**L**

Lacrosse-like move.....	25.2, 80.1
Last five minutes and overtime.....	19.4, Table 17
League inspections.....	11.8, 12.5

**Rule Number**

Leaving before time expires.....	36.1
Leaving the bench.....	70, Table 1, Table 3, Table 14
- awarded goal.....	70.8
- bench minor penalty.....	70.5
- disallowed goal.....	68.5, 70.9, 78.5
- during stoppages of play.....	70.3
- fines.....	70.10
- game misconduct penalty.....	70.6
- legal line change.....	70.2
- penalty bench.....	36.1, 40.5, 68.1, 68.5, 70.4, Table 12
- players' bench.....	70.3
- penalty shot.....	70.7
- protest.....	6.1, 40.2, Table 9
- suspensions.....	70.10
- without helmet during play.....	9.5
Leaving the goal crease.....	28.6, 32.9, Table 15
Leaving the ice during the play.....	8.1, 74.1
Leg guards.....	9.5, 11.2, 65.2
Legal line change.....	70.2
Light	
- commercial.....	4.1
- end of period.....	4.1
- goal.....	4.1
Line change.....	82
- delaying the game.....	63.3
- face-off procedure.....	76.3
- icing.....	81.4, 82.1
- legal line change.....	70.2
- procedure.....	82.2
- start of periods.....	86.8
- warning.....	76.6, 82.2
Lines.....	1.5, 28.7
Linesmen.....	33
- abuse of officials.....	40
- appointment of linesmen.....	31.1
- articles thrown on ice.....	33.4, 53.3, 75.2, 75.3, Table 1, Table 3
- attire and equipment.....	33.1
- equipment.....	33.1
- face-off responsibility.....	32.3, 33.2, 76.1
- goals.....	33.5, 78.5
- hand pass.....	33.5, 79
- high-stick causing injury.....	33.4, 60.3, 78.5
- high-sticking the puck.....	33.5, 80.1
- icing.....	33.3, 81
- ineligible player.....	5.2, 33.5, 70.4, 74.2, 78.5, 84.4
- injury – stopping play.....	8.1
- interference by/with spectators.....	23.7, 33.5
- jersey during fight.....	47.13, Table 10



	<b><u>Rule Number</u></b>
- leaving the bench .....	70.4
- line changes.....	82.2
- off-side .....	33.3, 83
- penalty shot – throwing equipment.....	33.5, 53.6
- physical abuse of officials.....	41
- premature substitution of the goalkeeper.....	33.5, 71.1, 74.1
- puck out of bounds .....	33.5, 85.1
- referee performing duties of linesman.....	32.4
- reporting foul that occurred prior to goal .....	33.4, 78.5
- reporting to the referee .....	33.4
- resisting a linesman.....	40.5, 41, 47.5, Table 10
- signals.....	30.9, 30.11, 30.12, 30.14, 30.18, 30.33
- stopping play.....	33.5
- stopping play for injury.....	8.1
- tie down (jersey) .....	47.13, Table 10
- throwing equipment – penalty shot.....	33.5, 53.6
- too many men on the ice .....	74.2
- unable to continue .....	33.6
<b>Line-up</b>	
- line change .....	82.1
- numbers.....	9.2
- start of periods .....	86.8
- starting .....	7, 34.1, 86.8, Table 3
Listed on game sheet.....	34.1
Littering the ice .....	63.4
Logos – on-ice .....	1.1
Loose pucks .....	69.6, 78.4, 83.3, Table 18
Low hit .....	45.1

## M

Major penalty .....	20, Table 5, Table 6, Table 7, ..... Table 10, Table 16, Table 17, Table 18
- boarding.....	42.3
- butt-ending.....	58.3
- charging .....	43.3
- checking from behind .....	44.3
- clipping.....	45.3
- coincidental major penalties .....	19.2
- cross-checking.....	59.3
- disallowed goal .....	78.5
- elbowing.....	46.3
- fighting .....	47.14
- goalkeeper penalties .....	28.2
- head-butting.....	48.3
- hooking.....	55.3
- interference.....	56.4
- kneeling.....	50.3



	<b><u>Rule Number</u></b>
- linesmen reporting .....	33.4
- penalty timekeeper .....	36.1
- roughing .....	51.1
- slashing .....	61.3
- spearing .....	62.3
- substitute .....	20.3
- when player (or team) assessed major plus minor penalty .....	27.3
- when player assessed major plus misconduct penalties .....	22.3
- when replacement player not placed on penalty bench – no icing .....	81.6
- when replacement player does not return to ice from penalty bench ..	68.2
Markings .....	1.1
Mask .....	9.5, 11.7, 75.2, Table 8
Match penalty .....	<b>21</b> , Table 8, Table 16
- boarding .....	42.4
- butt-ending .....	58.4
- charging .....	43.4
- checking from behind .....	44.4
- clipping .....	45.4
- coincidental match penalties .....	19.3
- cross-checking .....	59.4
- designated shooter for penalty shot .....	25.3
- disallowed goal .....	78.5
- elbowing .....	46.4
- fighting .....	47.15
- goalkeeper during the course of a penalty shot .....	25.4
- goalkeeper's penalties .....	28.5
- head-butting .....	48.4
- high-sticking .....	60.4
- kicking .....	49.3
- kneeling .....	50.4
- linesmen .....	33.4
- penalty timekeeper .....	36.6
- reports .....	32.9
- roughing .....	51.3
- shootout eligibility .....	84.4
- slashing .....	61.4
- slew-footing .....	52.2
- spearing .....	62.4
- tape on hands .....	47.15
- throwing equipment .....	53.5
Measurements	
- arm pads .....	11.3
- blocking glove .....	11.6
- catching glove .....	11.5
- chest pad .....	11.3
- curvature .....	10.1, 10.5
- deliberately breaking stick .....	10.5, Table 9
- goalkeeper's equipment .....	11



	<b><u>Rule Number</u></b>
- illegal stick – remain at penalty bench .....	10.5
- league inspections .....	11.8
- leg guards .....	11.2
- pants .....	11.4
- refusing to surrender stick .....	10.5, Table 9
- stick .....	10.5, 10.6
- stick gauge .....	36.2
- stick - prior to penalty shot .....	10.6
- stick - prior to shootout attempt .....	10.7, 84.4
- tape .....	10.5, 11.5, 32.1, 33.1, 36.2
- unsustained request for measurement .....	10.5, Table 3
Measuring tape .....	10.5, 11.5, 32.1, 33.1, 36.2
Medial rolls .....	11.2
Minor league goalkeeper .....	5.3, 11.8
Minor penalty .....	<b>16</b> , Table 2, Table 16, Table 17, Table 18, Table 20
- abuse of officials .....	40.2
- adjustment to clothing or equipment .....	14.1, 63.2, 65.2
- boarding .....	42.2
- broken stick .....	10.3, 10.4
- captain coming off bench .....	6.1
- charging .....	43.2
- checking from behind .....	44.2
- clipping .....	45.2
- closing hand on the puck .....	67.2, 67.3, 79.1
- coincidental minor penalties .....	19.1, Table 16, Table 18
- cross-checking .....	59.2
- dangerous equipment .....	9.6
- delayed calling of a penalty – no goal .....	78.5
- delayed penalties .....	27.1
- delay of game – dropping puck on netting .....	85.6
- delay of game – face-off violation .....	76.6
- delay of game – slow proceeding to face-off location .....	76.6
- delaying the game .....	63.2
- diving .....	64.2
- elbowing .....	46.2
- embellishment .....	64.2
- expiration criteria .....	16.2
- face-off violation .....	76.6
- goal scored .....	15.2
- goalkeeper leaving the crease .....	28.6
- goalkeeper playing puck in restricted area .....	28.8
- goalkeeper playing puck over center red line .....	28.7
- goalkeeper's penalties .....	28
- handling puck .....	67.2, 79.1
- high-sticking .....	60.2
- holding .....	54.2
- hooking .....	55.2
- illegal equipment .....	12.1





	<u>Rule Number</u>
- illegal stick.....	10.5
- improper starting line-up.....	7.2
- instigator.....	47.11
- instigator with face protection.....	47.6
- interference.....	56.2
- interference on the goalkeeper.....	69.2
- kneeling.....	50.2
- leaving the bench.....	70.4
- leaving the crease.....	28.6
- major plus minor assessed to same player at same time.....	20.1
- misconduct plus minor player substitute.....	22.3
- penalty timekeeper.....	36.1
- playing puck in restricted area.....	28.8
- playing puck over center red line.....	28.7
- premature substitution.....	71.1, 74.1
- protective equipment.....	9.5, 65.2
- restricted area.....	28.8
- roughing.....	51.2
- slashing.....	61.2
- starting line-up.....	7.2
- throwing equipment.....	53.2
- too many men on the ice.....	71.1, 74.1
- tripping.....	57.2
- unsportsmanlike conduct.....	40.2, 75.2
- unsustained request for measurement.....	10.5, 12.2
Mirrored image benches.....	3.1
Misconduct penalty.....	<b>22</b> , Table 9
- abuse of officials.....	40.4
- breaking stick when asked for measurement.....	10.5
- captain coming off bench.....	6.1
- coincidental minor penalties when misconducts assessed.....	19.1
- goalkeeper's penalties.....	28.3
- inciting an opponent.....	75.4, Table 9, Table 10
- interfering or distracting from bench on penalty shot.....	25.4
- linesmen reporting.....	33.4
- penalty timekeeper.....	36.1
- protective equipment.....	9.5
- reports by referee.....	32.9
- signal.....	30.23
- substitute.....	22.3
- unsportsmanlike conduct.....	75.4
Modified jersey.....	47.13, 75.2
Modified stick.....	9.5

**N**

Net dislodged.....	63.2, 63.5, 63.6, 78.4, 78.5
Nets.....	1.4, 1.7, <b>2</b>



	<b>Rule Number</b>
Netting .....	1.4, 85.1
Neutral zone .....	1.6
- face-offs .....	76.2
- face-off location – calling of penalties .....	15.5
- face-off location – interference on the goalkeeper .....	69.5
- face-off location – puck out of play .....	85.5
- hand pass .....	79.3
- high-sticking the puck .....	80.2
- icing – error .....	81.2
- off-side .....	83.5
- penalty bench .....	3.2
- premature substitution .....	71.1
- puck on back of net .....	85.5
- puck out of bounds .....	85.1
- puck striking official .....	85.4
NHL Officiating Staff .....	iii
No icing .....	30.33, 81.5
No off-side .....	83.2
Non-playing Club personnel	
- abuse of officials .....	40.3, 40.5, 40.6, Table 12
- altercation with a spectator .....	32.9
- attempt to injure non-playing Club personnel .....	75.5, Table 12
- awarded goal .....	53.7, 56.7, Table 1
- banging boards with stick .....	40.3, Table 1
- deliberate injury of non-playing Club personnel .....	75.5, Table 12
- distracting player or goalkeeper during penalty shot .....	25.4
- fighting .....	47.8
- interference with opponent on breakaway .....	56.6, 56.7, , Table 1
- interference while play in progress .....	56.3, Table 1
- interfering with an official .....	40.3, Table 1
- obscene language or gestures .....	40.3, 75.3, Table 1, Table 12
- penalty shot .....	25.4, 53.6, Table 1
- physical abuse of an official .....	41, Table 1, Table 12
- refusing to start play .....	73.3, Table 1
- spectator – altercation with .....	32.9
- stepping onto the ice .....	70.5, Table 1
- supplementary discipline .....	29, 40.7
- throwing stick or any object onto ice .....	40.3, 53.3, Table 1
Non-uniformed players .....	5.1, 5.4
Number .....	5.1, 7.2, 9.2, 32.5, 34.5
Numerical advantage .....	80.4, 81.6

## O

Objects thrown on ice .....	63.4
- public address .....	63.4
Obscene language or gestures .....	40, 75, Table 1, Table 12
Off the playing surface - fighting .....	47.8

**Rule Number**

Off-ice officials	
- action scorer.....	38.2
- appointment of .....	31
- commercial coordinator.....	4.1
- control of game officials .....	32
- game timekeeper .....	35
- goal judge.....	37
- leaving the penalty bench .....	70.4
- official scorer .....	34
- penalty scorer.....	38.2
- penalty timekeeper.....	36, 70.4
- puck supply .....	13
- real time scorers.....	38
- scoring system manager.....	38.2
- shot scorer .....	38.2
- spotter .....	38.2
- stats entry scorer.....	38.2
- time on ice scorer – home.....	38.2
- time on ice scorer – visitor .....	38.2
- video goal judge.....	39
Off-ice officials report of game misconduct/match penalties.....	36.6
Official report of match.....	34.1
Official Scorer .....	34
- abuse of officials .....	40.4
- captain and alternate captains .....	6.1, 34.1
- eligible players .....	5.1, 34.1
- goalkeeper's penalties .....	36.3
- goals and assists.....	32.5, 34.1, 34.2, 35.7, 39.6, 78.1
- ineligible player .....	5.2
- non-uniformed player.....	5.4
- official report of match.....	34.1
- penalties.....	32.7, 34.5
- starting line-up.....	7.1, 34.3
Officials .....	6, Section 5, 31, 40, 41
- abuse.....	6.1, 22.4, 23.4, 23.7, 32.9, 33.4, 40, Table 9
- appointment .....	31
- linesmen.....	33.4
- physical abuse .....	33.4, 41
- referees .....	32.9
Officiating Staff.....	iii
Off-side.....	83
- delayed.....	56.2, 83.3
- delaying the game.....	63.7
- deflections .....	83.2
- disallowed goal.....	83.4
- face-off – players in an off-side position .....	76.6
- forced off-side .....	56.2
- intentional.....	76, 83



	<u>Rule Number</u>
- linesmen .....	33.5
- puck striking official .....	85.4
- rebounds .....	83.2
- referee .....	32.4
- signal .....	30.7
- unnecessary contact .....	42.1
Original altercation – fighting after the .....	47.7
Other fouls .....	Section 9
Other than during the periods of the game - fighting .....	47.9
Out of bounds .....	85.1
Out of sight .....	85.3
Outer knee strap pad .....	11.2
Overtime .....	84
- coincidental penalties .....	19.1
- deliberate illegal substitution .....	74.4
- displacing the goal .....	63.5
- extra attacker – regular season .....	84.2
- line changes .....	82.2
- face-offs – five second time limit .....	76.3
- game timekeeper .....	35.3
- instigator .....	47.12
- penalties – major and minor (or double minor) .....	19.4, Table 17
- period length .....	35.3
- playoffs .....	84.5
- regular season .....	84.1
- regular season – penalties .....	84.3, Table 19, Table 20
- rest period .....	35.3
- shootout .....	84.4
- start of periods .....	86.8
- stick measurements .....	10.5, 10.7

## P

Pad risers .....	11.2
Pads	
- arm .....	11.3
- chest .....	11.3
- elbow .....	9.5, 12.3
Paint code .....	1.5, 1.7, 1.8
Palm removed or cut .....	12.2
Pants .....	9.1, 11.4, 47.13
Participating beyond the center red line .....	28.7, Table 2, Table 15
Participating in play with two sticks .....	10.5
Participating in play without helmet .....	9.5
Pegs .....	2.1, 63.6, 78.5
Penalties	
- assessed in overtime – regular season .....	Table 20
- calling of .....	15, Table 1

**Rule Number**

- coincidental (see Coincidental penalties)	
- face-off location	76.2
- in effect prior to the start of overtime – regular season	Table 19
- major and minor (or double minor)	19.4, Table 17
- public address	32.7, 36.1
Penalty – delayed	19.1, <b>27</b> , 30.8, 84.2, Table 16
Penalty bench	3.2
- articles thrown on ice – linesman reporting	33.4, 53.3, 75.2, 75.3, Table 1, Table 3
- commercial time-out light	4.1
- failure to proceed directly	47.19
- goalkeeper’s penalties	<b>28</b> , Table 15
- injured player – penalty	8.1, 68.1
- interference from bench	56.3, Table 3
- helmet	9.5
- illegal stick	10.5
- illegal substitution	<b>68</b> , Table 3
- leaving before time expires	36.1
- leaving the bench	70.4, Table 1, Table 3, Table 12, Table 14
- light – commercial time-out	4.1
- linesman reporting – articles thrown on ice	33.4, 53.3, 75.2, 75.3, Table 1, Table 3
- major penalty – substitute	20.3
- proceed directly – failure to	47.19
- protective glass	1.3, 3.2
- puck supply	13.2
- stick – illegal	10.5
- stick – thrown	10.3, 53.3, 75.3
- substitute for major penalty	20.3
- substitution – illegal	<b>68</b> , Table 3
- supply of pucks	13.2
- thrown stick	10.3, 53.3, 75.3
- time-out light	4.1
- too many men on the ice	74.3
Penalty expiration	16.2, 27.2, 36.1, Table 16
Penalty record form	36.6
Penalty scorer	38.2
Penalty shot	<b>25</b> , Table 9, Table 13
- awarded goal during penalty shot	26.4
- cradling the puck (like lacrosse)	25.2, 80.1
- delay of game – displacing goal post	63.5
- delay of game – falling on puck in crease	63.5, 67.4
- delayed calling of a penalty shot and goal scored	15.4
- deliberate illegal substitution	68.6, 74.4
- designated player	25.3
- distraction during	25.4
- fouled from behind	54.3, 55.5, 57.3, 61.6
- goalkeeper deliberately removing face mask	9.5

**Rule Number**

- goal scored – short-handed.....	16.2
- handling puck .....	67.4
- holding .....	54.3
- hooking .....	55.5
- interference.....	56.6, Table 1
- interference – illegally entered the game .....	68.3, 70.7
- injury to designated player .....	25.3
- lacrosse-like move.....	25.2, 80.1
- linesman authority – throwing equipment.....	33.5
- penalty timekeeper .....	36.4
- procedure.....	25.2
- public address .....	25.2
- shootout.....	84.4
- short-handed – goal scored on penalty shot.....	16.2
- signal .....	30.24
- slashing.....	61.6
- spin-o-rama move.....	25.2
- stick measurement prior to penalty shot .....	10.6
- third goalkeeper – no warm-up prior to penalty shot.....	5.3
- throwing equipment .....	33.4, 53.6, 53.7, 56.6, Table 1
- throwing stick .....	53.6, 53.7, 56.6, Table 1
- time-outs.....	87.1
- timing .....	25.7
- tripping.....	57.3
- violations during the shot.....	25.4
Penalty time clock.....	4.2, 36.5
- coincidental penalties .....	19.1, Table 17
- double-minor penalties .....	18.2
- game timekeeper.....	35.7
- official scorer .....	34.2
- penalty timekeeper .....	36.1, 36.5
- timing device.....	4.2
- verification of time.....	34.2, 35.7, 36.8, 39.6, 76.8, 85.7
Penalty timekeeper.....	36
- disallowed goal .....	68.5
- goalkeeper's penalties.....	36.3
- illegal substitution .....	68.5
- interfering with penalty timekeeper.....	40.3, 40.4
- leaving penalty bench early.....	36.1, 68.5, 70.4
- major and minor penalty assessed to same team .....	27.3
- penalty bench .....	3.2
- penalty expiration .....	27.2, 36.1, 36.5
- penalty shot .....	36.4
- penalty time clock.....	36.5
- referee's crease.....	1.7
- reports.....	36.6
- stick gauge.....	36.2
- stick measurement result .....	10.5, 36.7



	<b><u>Rule Number</u></b>
- team's choice – penalty expiration.....	16.2, 27.2
- verification of time.....	34.2, 35.7, 36.8, 76.8, 85.7
Period – end of.....	86.5, Table 3
Period length.....	35.1, 77.1, 84.1
Permitted to occupy players' bench.....	5.4
Physical abuse of officials.....	33.4, 41, Table 1, Table 12
Physical fouls.....	Section 6
Picking up puck in crease.....	67.4, 67.5, Table 13
Piling snow or other objects.....	67.5
Play was stopped.....	32.2, 78.5, 83.4
Player	
- eligible.....	5.1, 10.7, 34.1, 84.4
- ineligible.....	5.2, 10.7, 33.5, 74.5, 78.5, 84.4
- injured.....	8, 9.6, 68.2, 70.5, 76.2, 81.4, 82.1
- losing helmet.....	9.5
- substitution.....	68.1, 71.1, 74, 81.4, 82.1
- uniform.....	9.1, 32.8
Player's jersey.....	9.3
Players' bench.....	3.1
- articles thrown on ice – linesman reporting .....	33.4, 53.3, 75.2, 75.3, Table 1, Table 3
- attacking zone – extending into.....	83.3
- broken stick.....	10.3
- choice of ends.....	86.3
- clearing area of fight.....	47.4
- coaches and team personnel.....	5.4
- dimensions.....	3.1
- end of periods.....	86.5, Table 3
- extending into attacking zone.....	83.3
- fight – clearing area.....	47.4
- helmet.....	9.5
- illegal substitution.....	68.1, Table 3
- injured player leaving ice.....	8.1
- interference from bench.....	56.2, Table 3
- leaving the bench.....	70.3, Table 1, Table 3, Table 14
- leaving to protest.....	6.1, 40.2, Table 9
- linesman reporting – articles thrown on ice .....	33.4, 53.3, 75.2, 75.3, Table 1, Table 3
- measurement – stick.....	10.5
- non-uniformed players.....	5.4
- penalty shot.....	25.2
- permitted to occupy.....	5.4
- premature substitution.....	71.1
- protective glass.....	3.1
- puck striking glove.....	85.1
- receiving stick.....	10.3
- replacement stick.....	10.4
- start of game.....	86.3



	<b><u>Rule Number</u></b>
- start of periods .....	86.2, 86.8
- stick – broken .....	10.3
- stick – measurement .....	10.5
- stick – receiving .....	10.3
- stick – replacement .....	10.4
- stick – thrown .....	10.3, 10.4, 53.3, 75.3, Table 1, Table 3
- substitute goalkeeper .....	5.3, 71.1
- substitution – illegal .....	68, Table 3
- substitution – premature .....	71.1
- thrown stick .....	10.3, 10.4, 53.3, 75.3, Table 1, Table 3
- time-outs .....	87
- too many men on the ice .....	74
Player's stick .....	10.1
- face-off procedure .....	76.4
- face-off violation .....	76.6
- icing – determination .....	82.1
- icing – rebound .....	81.5
- prior to penalty shot .....	10.6, 25.4
Playing area .....	Section 1
Playing puck in restricted area .....	28.8
Playing puck over center red line .....	28.7
Playing surface – fighting off the .....	47.8
Playoffs .....	84.5
Police protection .....	41.8
Possession of the puck .....	56.1
- awarded goals .....	26.1
- calling of penalties .....	15.1
- displacing goal post .....	63.2
- fouling from behind .....	25.8, 57.3
- goalkeeper losing helmet and/or mask .....	9.5
- goalkeeper – premature substitution .....	71.1
- high-sticking the puck .....	80.1
- holding .....	54.1
- icing .....	81.1
- interference .....	56.1
- leaving the bench .....	70.7
- leaving penalty bench early .....	70.4
- illegal puck .....	13.3
- illegal substitution .....	68.3, 70.7
- injured players .....	8.1
- off-side .....	83.1
- participating in play without helmet .....	9.5
- penalty shot .....	25.8, 57.3, 63.5, 68.3, 70.7
- premature substitution .....	71.1
Post-game – fighting .....	47.9
Post-game verbal abuse .....	23.7
Posts (see Goal posts)	
Power-play	





	<u>Rule Number</u>
- high-sticking the puck .....	80.4
- icing .....	81.6
- numerical advantage .....	80.4, 81.6
- penalty expiration .....	27.2
Pre-game warm-up .....	86.6
Premature substitution (of goalkeeper) .....	71
- face-off location .....	76.2
- linesman stopping play .....	33.5
- public address .....	71.2
- too many men on the ice .....	74.1
Pre-season games	
- goalkeeper warm-up .....	8.2
- supplemental discipline .....	29.2
Preventing opponent from retrieving equipment .....	56.2
Prior to drop of puck – fighting .....	47.10
Prior to game – fighting .....	47.9
Prior to period – fighting .....	47.9
Procedure – penalty shot .....	25.2
Proceed directly to penalty bench – failure to .....	47.19
Profane language or gestures .....	40, 75, Table 1, Table 12
Protection – face .....	47.6
Protective equipment .....	9.5, 11, 12.1, 65.2, Table 9
Protective glass .....	1.3, 3
Public address	
- assists .....	32.5, 34.2
- disallowed goals .....	32.5, 39.2, 78.5
- game timekeeper .....	35.1
- goal review .....	39.2
- goals .....	32.5, 34.2, 39.2
- official scorer .....	34.2
- objects thrown on ice .....	63.4
- one minute remaining .....	35.1
- penalties .....	32.7, 36.1
- penalty shot .....	25.2
- premature substitution .....	71.2
- video goal judge .....	39.2
Puck .....	13
- coming to rest on top of boards .....	85.1
- deflecting off official directly into goal .....	76.2
- dropped on goal netting .....	85.6
- frozen along the boards .....	15.5, 85.2, 85.5
- frozen by the goalkeeper .....	15.5
- illegal .....	13.3, 56.2
- leaving surface through open bench door .....	85.1
- on back of net .....	85.2, 85.5
- out of bounds .....	33.5, <b>85</b>
- out of bounds off crossbar, post or goal frame .....	85.1, 85.5
- out of bounds off face-off .....	63.2, 85.1



	<b><u>Rule Number</u></b>
- out of sight .....	85.3
- over glass .....	63.2
- striking glove .....	85.1
- striking official .....	81.1, 85.4
- supply .....	13.2
- through net.....	39.4, 85.2
- under net.....	39.4, 85.2
- unplayable .....	63.2, 85.2
Puck foils .....	11.2
Punch causing injury .....	47.15, 51.3, Table 8

## R

Racial taunts or slurs .....	23.7
Raised seam ridges .....	11.2, 11.3, 11.6
Real time scorers.....	36.3, <b>38</b>
Rebound in the crease .....	69.6
Rebound off post on penalty shot .....	25.2
Rebounds	
- icing .....	81.5
- in crease .....	69.6
- penalty shot .....	25.2
Receivable pass .....	81.5
Receiving stick.....	10.3, 10.4
Referee crease .....	1.7, 40.4, Table 9
Referees .....	32
- abuse of officials .....	40
- appointment of officials .....	31
- attire and equipment.....	32.1
- calling of penalties .....	15.1
- coincidental penalty rule .....	19.5
- disputes .....	32.2
- end of game and periods.....	32.10
- entering referee's crease.....	1.7, 40.4, Table 9
- equipment .....	32.1
- face-offs .....	32.3
- goal judge .....	37.1, 37.2
- goals .....	32.5
- leaving the penalty bench early.....	36.1, 70.4
- linesmen reporting to referee .....	33.4
- line-ups .....	34.3
- off-ice officials.....	32.6
- penalties .....	32.7, 36.1
- physical abuse of officials.....	41
- player or goalkeeper's uniform .....	9.1
- player's uniforms .....	9.1, 32.8
- reports.....	32.9
- signals.....	30

**Rule Number**

- start of game and periods .....	32.10, 35.5
- team uniform .....	9.1, 32.8
- unable to continue .....	32.11
- verification of time .....	35.7, 39.6
- video goal judge .....	39
Refusing to play the puck .....	72
- hand pass .....	72.2
- high stick .....	72.3
- icing .....	72.4
- penalty .....	72.5
Refusing to start play .....	73, Table 1, Table 3
Refusing to surrender stick for measurement .....	10.5, Table 9
Remain in goal crease .....	47.4
Removing jersey .....	47.13, 75.2
Replacement stick .....	10.3, 10.4
Reporting to referee .....	33.4
Reports	
- abuse of officials – misconduct penalties .....	22.4, 32.9, 40.7
- altercation with a spectator .....	32.9
- event summary .....	38.3
- fighting off the playing surface .....	47.8
- fighting prior to the drop of the puck .....	47.10
- game misconduct penalties .....	23.2, 32.9
- game summary .....	38.3
- goalkeeper leaving crease .....	32.9
- instigator penalties .....	32.9, 47.11, 47.12
- instigator, aggressor and game misconduct list .....	36.6
- leaving the bench .....	70.10
- match penalties .....	21.3, 32.9
- misconduct penalties – abuse of officials .....	22.4, 32.9, 40.7
- off-ice officials report of game misconduct/match penalties .....	36.6
- penalty record form .....	36.1
- penalty timekeeper .....	36.6
- real time scorers .....	38.3
- spectator – altercation with .....	32.9
- thrown stick or object outside playing area .....	32.9
- unusual occurrence .....	32.9
- video goal judge .....	39.3
Request for review/rescind – instigator .....	47.11
Request for review / rescind – game misconduct .....	23.2
Requesting stick measurement .....	10.5
Rescind – instigator .....	47.11
Rescind – game misconduct .....	23.2
Resisting a linesman .....	47.5, Table 10
Rest period .....	35.3
Restrain .....	54.1, 55.1, 56.1, 56.2
Restraining fouls .....	Section 7
Restraining lines (hash marks) .....	1.9, 76.5



	<b>Rule Number</b>
Restricted area .....	1.8, 28.8, Table 15
Retrieving equipment after a fight .....	47.19
Rink.....	1, 3, 4, 85.1, 86.1
Rink Dimensions.....	1
Roughing .....	30.25, 51, Table 2
- fines .....	51.4
- match penalty .....	51.3
- minor penalty .....	51.2
- suspensions.....	51.4

## S

Safety glass .....	1.3
Scorer (see Official Scorer)	
Scoring a goal.....	78.4
Scoring system manager.....	38.2
Second fight same stoppage.....	47.7
Second instigator in a game.....	47.11
Security.....	11.8, 12.5, 41.8
Serious injury.....	8, 33.5, 40.2, 40.3
Shooting equipment .....	53.2, 53.6, 53.7
Shooting puck over glass .....	63.2
Shootout .....	10.7, 78.1, <b>84.4</b>
- cradling the puck (like lacrosse).....	80.1
- eligibility .....	84.4
- goalkeeper deliberately removing face mask.....	9.5
- stick measurement .....	10.7
Short-handed	
- bench minor penalties .....	17.2
- calling a penalty – goal scored.....	15.2
- coincidental penalties .....	19, Table 17
- double-minor penalties .....	18.2
- goal scored on penalty shot .....	16.2
- high-sticking the puck .....	80.4
- icing .....	81.6
- intentional off-side .....	83.6
- major penalties .....	20.2
- match penalties .....	21.2
- minor penalties .....	16.2, Table 16
- misconduct penalties.....	22.3
- off-side – intentional .....	83.6
- puck striking official .....	85.4
Shot scorer .....	38.2
Shoulder cap protectors .....	11.3
Shoulder clavicle protectors .....	11.3
Signal device .....	4.1, 35.4
Signals.....	30
Siren .....	4.1



	<u>Rule Number</u>
Situations subject to video review.....	39.4
Slashing .....	<b>61</b> , Table 2, Table 5, Table 6, Table 8, Table 11
- awarded goal.....	61.7
- fines.....	61.8
- game misconduct penalty .....	61.5
- major penalty.....	61.3
- match penalty.....	61.4
- minor penalty.....	61.2
- penalty shot.....	61.6
- signal.....	30.26
- suspensions .....	61.8
Slew-footing .....	<b>52</b> , Table 8
- fines.....	52.3
- match penalty.....	52.2
- suspensions .....	52.3
Sliding stick .....	10.4
Slow proceeding to face-off location.....	76.6
Spearing.....	<b>62</b> , Table 4, Table 5, Table 6, Table 8, Table 11
- double-minor penalty .....	15.3, <b>62.2</b>
- fines.....	62.6
- game misconduct penalty .....	62.5
- major penalty.....	62.3
- match penalty.....	62.4
- signal.....	30.27
- suspensions .....	62.6
Spectator – altercation with .....	23.7, 32.9, 33.5, 53.4
Spectator netting.....	1.4, 85.1
Spin-o-rama move .....	25.2
Spitting .....	23.7, 41.3, 41.4
Spots – face-off (see Face-off)	
Spotter.....	38.2
Start of game .....	86
Start of game – fighting.....	47.9
Start of period .....	35.5, 77.1, <b>86</b>
Starting line-up.....	<b>7</b> , 34.1, 34.3, 86.2, 86.8
Stats entry scorer.....	38.2
Stepping onto the ice .....	70.5, Table 1
Stick .....	10
- blade width .....	10.1
- broken .....	10.3, 10.4, 56.2, Table 2
- curvature .....	10.1, 10.5
- fouls.....	Section 8
- gauge .....	32.1, 33.1, 36.2
- goalkeeper .....	10.2, 11.1, 49.2
- illegal.....	10.5
- infractions.....	23.5, Section 8
- length.....	10.1
- length exception.....	10.1



	<b>Rule Number</b>
- measurement.....	10.5, 36.7, 84.4
- measurement prior to penalty shot.....	10.6
- measurement prior to shootout attempt.....	10.7, 84.4
- measurement result.....	10.5, 36.7
- modified.....	9.6
- player.....	10.1
- receiving.....	10.3, 10.4
- replacement.....	10.3, 10.4
- sliding.....	10.4
- thrown.....	10.3, 10.4, 53.2, 53.6, 53.7
.....	75.2, 75.3, 75.4, Table 1, Table 3
Stick infractions, boarding and checking from behind category.....	23.5
Stopping play.....	33.5, 63.2, 63.4, 67.1, Table 15
Stopping play for injury.....	8.1
Striking an official.....	41
Striking official – puck.....	78.5, 81.1, 85.4
Substitute goalkeeper.....	5.3, 71
Substitution	
- bench minor penalties.....	17.1
- coincidental penalties.....	19
- delaying the game.....	63.3
- deliberate illegal.....	68.6, 74.4, Table 3, Table 13
- face-offs.....	76.7
- goalkeeper.....	8.2, 25.2, 34.1, 63.3
- illegal.....	20.3, 68, 74.4, Table 3, Table 13
- injured goalkeeper.....	8.2
- injured player.....	8.1
- leaving the bench.....	70.1
- line change.....	82.1
- line change on icing.....	81.4, 82.1
- major penalties.....	20.3
- premature.....	33.5, 71, 74.1, 76.2
Summary of awarded goals.....	Table 14
Summary of bench minor penalties.....	Table 3
Summary of double minor penalties.....	Table 4
Summary of game misconduct fouls – “general category”.....	Table 10
Summary of game misconduct fouls – “stick-related category”.....	Table 11
Summary of game misconduct penalties.....	Table 12
Summary of goalkeeper penalties.....	Table 15
Summary of major penalties.....	Table 5
Summary of major penalties that result in automatic game misconduct ...	Table 6
Summary of major penalties that result in automatic game misconduct when there is injury to face or head.....	Table 7
Summary of match penalties.....	Table 8
Summary of minor penalties.....	Table 2
Summary of misconduct penalties.....	Table 9
Summary of penalties to coaches and non-playing club personnel.....	Table 1
Summary of penalty shots.....	Table 13

**Rule Number**

Supplementary discipline (see Discipline – supplementary)	
Supply of pucks.....	13.2
Suspensions	
- automatic.....	23.2, 23.3, 23.4, 23.5, 36.6, 41
.....	42.6, 44.6, 47.9, 47.20, 47.22
- abuse of officials category .....	23.4
- aggressor .....	47.17
- boarding .....	23.5, 42.6
- butt-ending .....	58.6
- charging .....	43.6
- checking from behind.....	23.5, 44.6
- clearing the area of a fight .....	47.18
- clipping .....	45.6
- cross-checking .....	59.6
- diving.....	64.3
- elbowing .....	46.6
- embellishment.....	64.3
- failure to proceed directly to penalty bench .....	47.19
- fighting other than during the periods of the game .....	47.20
- game misconduct penalties .....	23.3, 23.4, 23.5
- general category .....	23.3
- general category – playoffs.....	23.3
- goalkeeper’s equipment.....	11.8
- head-butting .....	48.6
- high-sticking .....	60.6
- hooking.....	55.6
- instigator.....	47.21
- instigator in final five minutes.....	47.22
- interference on the goalkeeper .....	69.7
- kicking .....	49.4
- kneeling.....	50.6
- leaving the bench.....	70.10
- playoffs – general category.....	23.3
- playoffs – stick infractions, boarding, checking from behind category .....	23.5
- roughing .....	51.4
- slashing .....	61.7
- slew-footing .....	52.3
- spearing .....	62.6
- stick infractions, boarding, checking from behind category.....	23.5
- stick infractions, boarding, checking from behind category - playoffs .....	23.5
- stick measurements .....	10.5
- supplementary discipline.....	29
- throwing equipment.....	53.8
Sweater (jersey).....	9, 47.13, 75.2, Table 10
- goalkeeper .....	9.4
- player.....	9.3

**Rule Number****T**

Tag up.....	83.3
Tape measure .....	10.5, 11.5, 32.1, 33.1, 36.2
Tape on hands.....	47.15, Table 8
Tape on stick .....	10.1
Team.....	Section 2
Team personnel.....	5.4, 33.4, 75.3, 75.5, 75.6
Team uniform .....	9.1, 32.8
Team's choice – penalty expiration.....	16.2, 27.2
Television .....	34.1, 35.6, 47.20, 70.10
Thigh pads.....	11.4
Third goalkeeper – no warm-up prior to penalty shot .....	5.3
Third instigator in season .....	47.11, 47.21
Third major penalty in a game.....	20.4
Third man in.....	47.16, Table 12
Threaten to injure an official.....	41.4
Throwing equipment.....	33.5, <b>53</b> , 56.6, Table 1, Table 8, Table 13
- at an official.....	41.4
- awarded goal .....	53.7
- bench minor penalty .....	53.3
- fines .....	53.8
- game misconduct penalty.....	53.4
- match penalty .....	53.5
- minor penalty .....	53.2
- misconduct penalty.....	53.4
- out of playing area .....	40.4, 75.4
- penalty shot .....	53.6
- puck .....	67.3
- stick.....	10.3, 10.4, 53, 75.1, 75.2, 75.4, Table 1, Table 3
- suspensions.....	53.8
Throwing objects .....	40.3, 53, 75.1, 75.2, 75.4, Table 1, Table 12
- at spectator.....	23.7
- objects onto the ice.....	53, 75.1, 75.2
- objects outside playing surface .....	32, 75.4
Tie down (jersey).....	47.13, Table 10
Tied games (see Overtime)	
Time clock .....	4.2, 35.1, 36.1
Timekeeper (see Game timekeeper)	
Time on ice – home.....	38.2
Time on ice – visitor .....	38.2
Time-out .....	4.1, 30.29, 34.1, <b>87</b>
Timing device .....	<b>4</b> , 35.1, 36.1, 39.6
Too many men on the ice.....	71.1, <b>74</b> , Table 3
- bench minor penalty .....	74.2
- deliberate illegal substitution .....	74.4
- goalkeeper.....	74.5
- illegal substitution .....	68, Table 3





	<b><u>Rule Number</u></b>
- leaving the bench .....	70
- line change procedure .....	82.2
- linesmen reporting to referee .....	33.4
- no icing .....	81.5
- overtime – regular season .....	74.5
- penalty bench .....	74.3
- premature substitution .....	71
Torn jersey .....	9.5
Torso .....	47.13
Trapezoid .....	1.8
Tripping .....	<b>57</b> , 61.6, Table 2, Table 14
- awarded goal .....	54.4, 55.6, <b>57.4</b> , 61,7
- minor penalty .....	57.2
- penalty shot .....	53.6, 54.3, 55.5, <b>57.3</b> , 61.6
- signal .....	30.31
Two players penalties expire at the same time – team choice .....	16.2
Two sticks – participating in the play with .....	10.5
Types of penalties .....	Section 4

## U

Unable to continue – referee, linesman .....	32.11, 33.6
Uniform .....	5.1, 6, 8.3, <b>9</b> , 12.1, 32.8, 65.1
Unique to goalkeepers – penalties .....	28.9, Table 15
Unnecessary stoppage of play .....	67.3
Unsportsmanlike conduct .....	<b>40</b> , <b>75</b> , Table 2, Table 3, Table 12
- abuse of officials .....	40
- after original penalty .....	40.2
- banging boards with stick .....	40.2
- banging glass in protest of ruling .....	40.2
- bench minor penalty .....	40.3, 75.3
- biting .....	75.2
- captain or alternate captain coming off bench to protest .....	6.1
- face protection – instigator .....	47.6, 75.2
- game misconduct penalty .....	40.5, 75.5
- grabbing face mask .....	75.2
- hair pulling .....	75.2
- instigator wearing a face shield .....	47.6, 75.2
- jersey – removing .....	47.13, 75.2
- linesmen reporting to referee .....	33.4
- minor penalty .....	40.2, 75.2
- misconduct penalty .....	40.4, 75.4
- obscene, profane or abusive language or gestures .....	40, 75
- removing jersey .....	47.13, 75.2
- reports .....	40.7, 75.7
- signal .....	30.32
- throwing objects onto the ice .....	53.3, 75.2, 75.3
- throwing objects outside playing surface .....	40.4, 75.4

**Rule Number**

- wearing a face shield – instigator .....	47.6, 75.2
Unsustained complaint regarding legality of a glove.....	12.2
Unsustained request for measurement.....	10.5, 12.2, Table 3
Unusual occurrence .....	32.9

**V**

Verification of time.....	32.2, 34.2, 35.7, 36.8, 39.6, 76.8, 85.7
Video Goal Judge.....	<b>39</b> , 78.6
- appointment of officials.....	31
- equipment.....	39.5
- goals .....	32.5, 34.2, 39.2, 78.6
- logistics.....	39.5
- public address .....	39.2
- reports.....	39.3
- situations subject to video review.....	39.4
- verification of time.....	32.2, 35.7, 36.8, 39.6, 76.8, 85.7
- video review.....	39, 78.6
Video review .....	36.8, 39, 78.6
Violations during penalty shot .....	25.4
Violation – starting line-up.....	7.2

**W**

Wall (see Boards)	
Warm-up.....	5.3, 8.2, 34.3, 86.6, 87
- during stoppages of play .....	70.3
- during time-out.....	87
- for substitute goalkeeper .....	8.2
- start of period.....	86.8
Warning – line change.....	76.6, 82.2
Wash out .....	30.33
Wearing a face shield – instigator.....	47.6, 75.2
Wearing tape on hands .....	47.15, Table 8
When replacement player does not return to ice from penalty bench .....	68.1
When replacement player not placed on penalty bench – no icing .....	81.6
Whistle had blown .....	32.2, 78.5, 83.4

**Z**

Zone	
- attacking (see Attacking zone)	
- defending (see Defending zone)	
- neutral (see Neutral zone)	



# NHL Schedule, 2009-10

GAME #	VISITOR	HOME	GAME #	VISITOR	HOME	GAME #	VISITOR	HOME	GAME #	VISITOR	HOME
<b>THU. OCT. 1</b>			<b>FRI. OCT. 9</b>			<b>SAT. OCT. 17</b>			<b>SAT. OCT. 24</b>		
1	WSH	BOS	47	FLA	CAR	93	ATL	BUF	143	EDM	CGY
2	MTL	TOR	48	DAL	CGY	94	NYR	TOR	144	CBJ	ANA
3	S.J.	COL	<b>SAT. OCT. 10</b>			95	OTT	MTL	<b>SUN. OCT. 25</b>		
4	VAN	CGY	49	NYI	BOS	96	CAR	N.J.	145	S.J.	PHI
<b>FRI. OCT. 2</b>			50	PIT	TOR	97	S.J.	NYI	146	CBJ	L.A.
5	PHI	CAR	51	ATL	OTT	98	NSH	WSH	147	EDM	VAN
6	NYR	PIT	52	ANA	PHI	99	COL	DET	<b>MON. OCT. 26</b>		
*7	FLA	CHI	53	N.J.	FLA	100	L.A.	CBJ	148	PHX	NYR
* in Helsinki			54	WSH	DET	101	T.B.	PIT	149	NYI	MTL
**8	DET	ST.L.	55	CAR	T.B.	102	DAL	CHI	150	MIN	CHI
** in Stockholm			56	L.A.	ST.L.	103	BOS	PHX	151	TOR	ANA
<b>SAT. OCT. 3</b>			57	BUF	NSH	104	MIN	VAN	<b>TUE. OCT. 27</b>		
9	VAN	COL	58	COL	CHI	105	ST.L.	ANA	152	PHI	WSH
10	CAR	BOS	59	CBJ	PHX	<b>MON. OCT. 19</b>			153	COL	EDM
11	MTL	BUF	60	MTL	EDM	106	S.J.	NYR	154	DET	VAN
12	PHI	N.J.	61	MIN	S.J.	107	L.A.	DAL	<b>WED. OCT. 28</b>		
13	PIT	NYI	<b>SUN. OCT. 11</b>			108	VAN	EDM	155	BUF	N.J.
14	OTT	NYR	62	ANA	NYR	<b>TUE. OCT. 20</b>			156	NYR	NYI
15	TOR	WSH	63	DAL	VAN	109	ST.L.	PIT	157	ST.L.	CAR
16	T.B.	ATL	<b>MON. OCT. 12</b>			110	ATL	MTL	158	PHX	CBJ
*17	CHI	FLA	64	COL	BOS	111	CBJ	CGY	159	MTL	PIT
* in Helsinki			65	L.A.	NYI	<b>WED. OCT. 21</b>			160	OTT	FLA
18	MIN	CBJ	66	TOR	NYR	112	NSH	BOS	161	NSH	MIN
19	NSH	DAL	67	N.J.	WSH	113	CAR	NYI	162	TOR	DAL
**20	ST.L.	DET	68	PIT	OTT	114	BUF	FLA	163	COL	CGY
** in Stockholm			69	FLA	T.B.	115	COL	MIN	164	L.A.	S.J.
21	CGY	EDM	70	EDM	NSH	116	VAN	CHI	<b>THU. OCT. 29</b>		
22	S.J.	ANA	71	CGY	CHI	117	DAL	ANA	165	N.J.	BOS
23	PHX	L.A.	72	PHX	S.J.	<b>THU. OCT. 22</b>			166	WSH	ATL
<b>MON. OCT. 5</b>			<b>TUE. OCT. 13</b>			118	NYI	MTL	167	OTT	T.B.
24	NYR	N.J.	73	DET	BUF	119	N.J.	NYR	168	PHX	ST.L.
25	CBJ	VAN	74	CGY	CBJ	120	BOS	PHI	169	CHI	NSH
<b>TUE. OCT. 6</b>			75	COL	TOR	121	WSH	ATL	170	DET	EDM
26	OTT	TOR	<b>WED. OCT. 14</b>			122	NSH	OTT	171	VAN	L.A.
27	WSH	PHI	76	L.A.	NYR	123	S.J.	T.B.	<b>FRI. OCT. 30</b>		
28	T.B.	CAR	77	EDM	CHI	124	CBJ	EDM	172	NYI	WSH
29	ANA	MIN	78	NSH	DAL	125	DET	PHX	173	PIT	CBJ
30	MTL	CGY	79	MIN	ANA	126	DAL	L.A.	174	TOR	BUF
31	DAL	EDM	81	PIT	CAR	<b>FRI. OCT. 23</b>			175	NYR	MIN
32	S.J.	L.A.	<b>THU. OCT. 15</b>			127	FLA	PIT	176	MTL	CHI
<b>WED. OCT. 7</b>			80	S.J.	WSH	128	MIN	ST.L.	177	FLA	DAL
33	PHX	PIT	82	COL	MTL	129	CAR	COL	178	VAN	ANA
34	MTL	VAN	83	T.B.	OTT	<b>SAT. OCT. 24</b>			179	COL	S.J.
<b>THU. OCT. 8</b>			84	L.A.	DET	130	NYR	MTL	<b>SAT. OCT. 31</b>		
35	ANA	BOS	85	CHI	NSH	131	BOS	OTT	180	EDM	BOS
36	PHX	BUF	86	ST.L.	PHX	132	WSH	NYI	181	CAR	PHI
37	NYI	OTT	<b>FRI. OCT. 16</b>			133	FLA	PHI	182	ATL	OTT
38	PIT	PHI	87	ATL	N.J.	134	S.J.	ATL	183	N.J.	T.B.
39	NYR	WSH	88	NYI	BUF	135	TOR	VAN	184	TOR	MTL
40	N.J.	T.B.	89	PHI	FLA	136	N.J.	PIT	185	BUF	NYI
41	CHI	DET	90	BOS	DAL	137	BUF	T.B.	186	MIN	PIT
42	ATL	ST.L.	91	VAN	CGY	138	DAL	ST.L.	187	FLA	ST.L.
43	COL	NSH	92	MIN	EDM	139	CAR	MIN	188	DAL	NSH
44	CGY	EDM									
45	MIN	L.A.									
46	CBJ	S.J.									

Copyright © 2008 by the National Hockey League. All rights reserved. Reproduction in whole or in part without permission of the National Hockey League is strictly prohibited. Publication of this schedule is permitted for the sole purpose of informing members of the public who wish to attend or view on television National Hockey League games. Any other publication or other use of any portion of this schedule, including for the purpose of lottery or other form of gambling, whether such gambling is legal or illegal is strictly prohibited.

SUBJECT TO CHANGE

• AFTERNOON GAME



# NHL SCHEDULE 2009-10



GAME #	VISITOR	HOME
<b>SUN. NOV. 1</b>		
191	• BOS	NYR
192	• S.J.	CAR
193	CBJ	WSH
194	COL	VAN
<b>MON. NOV. 2</b>		
195	EDM	NYI
196	T.B.	PHI
197	L.A.	PHX
<b>TUE. NOV. 3</b>		
198	BOS	DET
199	T.B.	TOR
200	ATL	MTL
201	NYR	VAN
202	PIT	ANA
<b>WED. NOV. 4</b>		
203	NYI	BUF
204	WSH	N.J.
205	S.J.	CBJ
206	CAR	FLA
207	CGY	DAL
208	PHX	COL
<b>THU. NOV. 5</b>		
209	MTL	BOS
210	CBJ	ATL
211	T.B.	OTT
212	S.J.	DET
213	CGY	ST.L.
214	VAN	MIN
215	CHI	PHX
216	NYR	EDM
217	NSH	ANA
218	PIT	L.A.
<b>FRI. NOV. 6</b>		
219	NYI	N.J.
220	TOR	CAR
221	PHI	BUF
222	WSH	FLA
223	VAN	DAL
224	CHI	COL
<b>SAT. NOV. 7</b>		
225	• NSH	L.A.
226	BUF	BOS
227	DET	TOR
<i>Hockey Hall of Fame Game</i>		
228	T.B.	MTL
229	N.J.	OTT
230	ATL	NYI
231	ST.L.	PHI
232	FLA	WSH
233	CAR	CBJ
234	DAL	MIN
235	NYR	CGY
236	PHX	ANA
237	PIT	S.J.
<b>SUN. NOV. 8</b>		
238	ST.L.	ATL
239	EDM	COL
<b>MON. NOV. 9</b>		
240	L.A.	CHI
<b>TUE. NOV. 10</b>		
241	PIT	BOS
242	MIN	TOR
243	CGY	MTL
244	EDM	OTT
245	VAN	ST.L.
246	NSH	S.J.

GAME #	VISITOR	HOME
<b>WED. NOV. 11</b>		
247	EDM	BUF
248	ANA	N.J.
249	NYI	WSH
250	L.A.	CAR
251	DET	CBJ
252	COL	CHI
<b>THU. NOV. 12</b>		
253	FLA	BOS
254	ATL	NYR
255	OTT	PHI
256	N.J.	PIT
257	MIN	T.B.
258	VAN	DET
259	NSH	ST.L.
260	MTL	PHX
261	DAL	S.J.
<b>FRI. NOV. 13</b>		
262	MIN	WSH
263	NYI	CAR
264	ANA	CBJ
265	CGY	BUF
266	L.A.	ATL
267	TOR	CHI
<b>SAT. NOV. 14</b>		
268	CGY	TOR
269	NYR	OTT
270	WSH	N.J.
271	BUF	PHI
272	NYI	FLA
273	ANA	DET
274	BOS	PIT
275	L.A.	T.B.
276	S.J.	ST.L.
277	MTL	NSH
278	DAL	PHX
279	VAN	COL
<b>SUN. NOV. 15</b>		
280	• MIN	CAR
281	• EDM	ATL
282	S.J.	CHI
<b>MON. NOV. 16</b>		
283	NYI	BOS
284	N.J.	PHI
285	EDM	CBJ
286	ANA	PIT
287	L.A.	FLA
288	T.B.	PHX
<b>TUE. NOV. 17</b>		
289	WSH	NYR
290	CAR	MTL
291	TOR	OTT
292	S.J.	NSH
293	COL	CGY
<b>WED. NOV. 18</b>		
294	FLA	BUF
295	DAL	DET
296	PHX	MIN
297	COL	EDM
298	PHI	L.A.
<b>THU. NOV. 19</b>		
299	TOR	CAR
300	BOS	ATL
301	PIT	OTT
302	PHX	ST.L.

• AFTERNOON GAME

GAME #	VISITOR	HOME
<b>THU. NOV. 19</b>		
303	N.J.	NSH
304	CBJ	DAL
305	CHI	CGY
306	T.B.	ANA
<b>FRI. NOV. 20</b>		
307	MTL	WSH
308	BOS	BUF
309	FLA	DET
310	NYI	MIN
311	COL	VAN
312	PHI	S.J.
<b>SAT. NOV. 21</b>		
313	• CGY	L.A.
314	WSH	TOR
315	DET	MTL
316	BUF	OTT
317	FLA	NYR
318	T.B.	CAR
319	PIT	ATL
320	NYI	ST.L.
321	CBJ	NSH
322	N.J.	DAL
323	PHI	PHX
324	CHI	EDM
325	S.J.	ANA
<b>SUN. NOV. 22</b>		
326	T.B.	ATL
327	CHI	VAN
<b>MON. NOV. 23</b>		
328	DET	NSH
329	NYI	TOR
330	CBJ	NYR
331	WSH	OTT
332	PIT	FLA
333	BOS	ST.L.
334	CAR	DAL
335	PHI	COL
336	PHX	EDM
337	CGY	ANA
<b>TUE. NOV. 24</b>		
338	CBJ	MTL
<b>WED. NOV. 25</b>		
339	OTT	N.J.
340	PHI	NYI
341	BUF	WSH
342	TOR	T.B.
343	MTL	PIT
344	NYR	FLA
345	ATL	DET
346	BOS	MIN
347	ST.L.	DAL
348	NSH	COL
349	PHX	CGY
350	L.A.	EDM
351	CAR	ANA
352	CHI	S.J.
<b>THU. NOV. 26</b>		
353	CBJ	OTT
354	L.A.	VAN
<b>FRI. NOV. 27</b>		
355	• N.J.	BOS
356	• BUF	PHI
357	• PIT	NYI
358	• COL	MIN
359	• CHI	ANA

GAME #	VISITOR	HOME
<b>FRI. NOV. 27</b>		
360	ATL	CAR
361	NYR	T.B.
362	TOR	FLA
363	CGY	DET
364	ST.L.	NSH
365	S.J.	EDM
366	DAL	PHX
<b>SAT. NOV. 28</b>		
367	• NYI	N.J.
368	OTT	BOS
369	CAR	BUF
370	WSH	MTL
371	PHI	ATL
372	CGY	CBJ
373	NYR	PIT
374	DET	ST.L.
375	FLA	NSH
376	T.B.	DAL
377	MIN	COL
378	EDM	VAN
379	CHI	L.A.
<b>SUN. NOV. 29</b>		
380	PHX	ANA
381	S.J.	VAN
<b>MON. NOV. 30</b>		
382	BUF	TOR
383	PIT	NYR
384	WSH	CAR
385	FLA	ATL
386	ST.L.	CBJ
387	COL	T.B.
388	DAL	DET
389	CGY	NSH
<b>TUE. DEC. 1</b>		
390	TOR	MTL
391	CBJ	CHI
392	L.A.	ANA
393	OTT	S.J.
<b>WED. DEC. 2</b>		
394	T.B.	BOS
395	VAN	N.J.
396	COL	FLA
397	NSH	MIN
<b>THU. DEC. 3</b>		
398	MTL	BUF
399	VAN	PHI
400	FLA	WSH
401	NYI	ATL
402	TOR	CBJ
403	COL	PIT
404	EDM	DET
405	ANA	DAL
406	CGY	PHX
407	OTT	L.A.
408	ST.L.	S.J.
<b>FRI. DEC. 4</b>		
409	T.B.	N.J.
410	BOS	MTL
411	ANA	MIN
412	NSH	CHI
<b>SAT. DEC. 5</b>		
413	• VAN	CAR
414	• EDM	DAL
415	• ST.L.	L.A.
416	TOR	BOS



# NHL SCHEDULE 2009-10



GAME #	VISITOR	HOME
<b>SAT. DEC. 5</b>		
417	NYR	BUF
418	DET	N.J.
419	WSH	PHI
420	ATL	FLA
421	COL	CBJ
422	CHI	PIT
423	NYI	T.B.
424	MIN	NSH
425	OTT	PHX
426	CGY	S.J.
<b>SUN. DEC. 6</b>		
427	DET	NYR
428	OTT	ANA
<b>MON. DEC. 7</b>		
429	N.J.	BUF
430	ATL	TOR
431	PHI	MTL
432	CAR	PIT
433	WSH	T.B.
434	EDM	FLA
435	COL	ST.L.
436	MIN	PHX
437	CGY	L.A.
<b>TUE. DEC. 8</b>		
438	NYI	PHI
439	MTL	OTT
440	VAN	NSH
441	DAL	ANA
<b>WED. DEC. 9</b>		
442	WSH	BUF
443	NYI	TOR
444	CAR	N.J.
445	FLA	CBJ
446	EDM	T.B.
447	ST.L.	DET
448	NYR	CHI
449	MIN	COL
450	ATL	CGY
451	L.A.	S.J.
<b>THU. DEC. 10</b>		
452	TOR	BOS
453	OTT	PHI
454	PIT	MTL
455	CBJ	NSH
456	ATL	VAN
457	PHX	L.A.
<b>FRI. DEC. 11</b>		
458	FLA	N.J.
459	CAR	WSH
460	CHI	BUF
461	ANA	DET
462	EDM	ST.L.
463	T.B.	COL
464	MIN	CGY
465	DAL	S.J.
<b>SAT. DEC. 12</b>		
466	WSH	TOR
467	CAR	OTT
468	PHI	N.J.
469	BOS	NYI
470	BUF	NYR
471	MTL	ATL
472	ANA	CBJ
473	FLA	PIT
474	DET	NSH
475	S.J.	PHX

GAME #	VISITOR	HOME
<b>SAT. DEC. 12</b>		
476	MIN	VAN
477	DAL	L.A.
<b>SUN. DEC. 13</b>		
478	T.B.	CHI
479	CGY	COL
<b>MON. DEC. 14</b>		
480	PHI	BOS
481	OTT	TOR
482	FLA	NYI
483	ATL	NYR
484	NSH	CBJ
485	BUF	MTL
486	PHX	DET
487	L.A.	VAN
<b>TUE. DEC. 15</b>		
488	PHI	PIT
489	CGY	ST.L.
490	T.B.	NSH
491	CBJ	MIN
492	WSH	COL
493	L.A.	EDM
<b>WED. DEC. 16</b>		
494	MTL	N.J.
495	NYI	NYR
496	DAL	CAR
497	PHX	TOR
498	BUF	OTT
499	ATL	FLA
500	ST.L.	CHI
501	ANA	VAN
<b>THU. DEC. 17</b>		
502	MIN	MTL
503	NYR	NYI
504	PIT	PHI
505	DAL	ATL
506	PHX	CBJ
507	T.B.	DET
508	L.A.	CGY
509	NSH	EDM
510	ANA	S.J.
<b>FRI. DEC. 18</b>		
511	OTT	N.J.
512	TOR	BUF
513	CAR	FLA
514	T.B.	ST.L.
515	BOS	CHI
516	WSH	VAN
<b>SAT. DEC. 19</b>		
517	• NYR	PHI
518	• DET	DAL
519	• PHX	ANA
520	PIT	BUF
521	BOS	TOR
522	MIN	OTT
523	MTL	NYI
524	FLA	CAR
525	N.J.	ATL
526	NSH	CGY
527	CBJ	COL
528	WSH	EDM
<b>SUN. DEC. 20</b>		
529	DET	CHI
530	ST.L.	VAN

GAME #	VISITOR	HOME
<b>MON. DEC. 21</b>		
531	BUF	TOR
532	T.B.	NYI
533	FLA	PHI
534	NYR	CAR
535	MTL	ATL
536	BOS	OTT
537	N.J.	PIT
538	COL	MIN
539	S.J.	DAL
540	ST.L.	EDM
541	CBJ	PHX
<b>TUE. DEC. 22</b>		
542	S.J.	CHI
543	ANA	COL
544	NSH	VAN
<b>WED. DEC. 23</b>		
545	ATL	BOS
546	TOR	NYI
547	FLA	NYR
548	OTT	PIT
549	BUF	WSH
550	MTL	CAR
551	EDM	MIN
552	PHI	T.B.
553	CHI	DET
554	CBJ	DAL
555	ANA	PHX
556	ST.L.	CGY
<b>SAT. DEC. 26</b>		
557	OTT	BUF
558	MTL	TOR
559	NYI	NYR
560	N.J.	WSH
561	PHI	CAR
562	CBJ	DET
563	ATL	T.B.
564	CHI	NSH
565	ST.L.	MIN
566	L.A.	PHX
567	DAL	COL
568	EDM	VAN
569	ANA	S.J.
<b>SUN. DEC. 27</b>		
570	PHI	NYI
571	BOS	FLA
572	BUF	ST.L.
573	TOR	PIT
574	NSH	CHI
575	VAN	CGY
<b>MON. DEC. 28</b>		
576	ATL	N.J.
577	CAR	WSH
578	DET	CBJ
579	MTL	OTT
580	BOS	T.B.
581	CGY	EDM
582	MIN	L.A.
583	PHX	S.J.
<b>TUE. DEC. 29</b>		
584	PIT	BUF
585	CBJ	NYI
586	NSH	ST.L.
587	CHI	DAL
588	VAN	PHX
589	MIN	ANA

GAME #	VISITOR	HOME
<b>WED. DEC. 30</b>		
590	ATL	BOS
591	PIT	N.J.
592	PHI	NYR
593	MTL	T.B.
594	COL	OTT
595	L.A.	CGY
596	TOR	EDM
597	WSH	S.J.
<b>THU. DEC. 31</b>		
598	MTL	FLA
599	NYI	OTT
600	COL	DET
601	NSH	CBJ
602	S.J.	PHX
603	NYR	CAR
604	VAN	ST.L.
605	L.A.	MIN
606	ANA	DAL
607	N.J.	CHI
608	EDM	CGY
<b>FRI. JAN. 1</b>		
▲609	• PHI	BOS
▲ <i>Winter Classic outdoor game</i>		
610	ATL	BUF
<b>SAT. JAN. 2</b>		
611	• CAR	NYR
612	• VAN	DAL
613	• PIT	T.B.
614	• WSH	L.A.
615	ATL	NYI
616	COL	CBJ
617	TOR	CGY
618	CHI	ST.L.
619	ANA	NSH
620	N.J.	MIN
621	DET	PHX
622	EDM	S.J.
<b>SUN. JAN. 3</b>		
623	• BUF	MTL
624	• PHI	OTT
625	PIT	FLA
626	ANA	CHI
<b>MON. JAN. 4</b>		
627	BOS	NYR
628	L.A.	S.J.
<b>TUE. JAN. 5</b>		
629	FLA	TOR
630	DAL	N.J.
631	MTL	WSH
632	BOS	OTT
633	ATL	PIT
634	CGY	NSH
635	MIN	CHI
636	PHX	EDM
637	CBJ	VAN
638	DET	ANA
<b>WED. JAN 6</b>		
639	T.B.	BUF
640	DAL	NYR
641	TOR	PHI
642	CGY	MIN
643	NYI	COL
644	ST.L.	S.J.



# NHL SCHEDULE 2009-10



GAME #	VISITOR	HOME
<b>THU. JAN. 7</b>		
645	CHI	BOS
646	OTT	WSH
647	NYR	ATL
648	FLA	MTL
649	PHI	PIT
650	CAR	NSH
651	CBJ	EDM
652	PHX	VAN
653	ST.L.	ANA
654	DET	L.A.
<b>FRI. JAN. 8</b>		
655	T.B.	N.J.
656	COL	CAR
657	TOR	BUF
658	NYI	DAL
659	CBJ	CGY
<b>SAT. JAN. 9</b>		
660	• NYR	BOS
661	COL	BUF
662	PIT	TOR
663	N.J.	MTL
664	FLA	OTT
665	T.B.	PHI
666	WSH	ATL
667	ANA	NSH
668	CHI	MIN
669	NYI	PHX
670	CGY	VAN
671	ST.L.	L.A.
672	DET	S.J.
<b>SUN. JAN. 10</b>		
673	OTT	CAR
674	DAL	CBJ
675	ANA	CHI
<b>MON. JAN. 11</b>		
676	PIT	MIN
677	COL	CGY
678	NSH	VAN
679	S.J.	L.A.
<b>TUE. JAN. 12</b>		
680	CAR	TOR
681	DET	NYI
682	N.J.	NYR
683	DAL	PHI
684	OTT	ATL
685	WSH	T.B.
686	CBJ	ST.L.
687	NSH	EDM
688	S.J.	PHX
<b>WED. JAN. 13</b>		
689	VAN	MIN
690	WSH	FLA
691	PIT	CGY
692	BOS	ANA
<b>THU. JAN. 14</b>		
693	PHI	TOR
694	OTT	NYR
695	BUF	ATL
696	DAL	MTL
697	FLA	T.B.
698	CAR	DET
699	MIN	ST.L.
700	CBJ	CHI
701	N.J.	PHX
702	PIT	EDM
703	ANA	L.A.
704	BOS	S.J.

GAME #	VISITOR	HOME
<b>FRI. JAN. 15</b>		
705	TOR	WSH
706	NSH	CGY
<b>SAT. JAN. 16</b>		
707	• CHI	CBJ
708	• DET	DAL
709	• N.J.	COL
710	• BOS	L.A.
711	• EDM	S.J.
712	OTT	MTL
713	BUF	NYI
714	T.B.	FLA
715	ATL	CAR
716	NYR	ST.L.
717	MIN	PHX
718	PIT	VAN
<b>SUN. JAN. 17</b>		
719	• PHI	WSH
720	• CHI	DET
721	MTL	NYR
722	CGY	ANA
<b>MON. JAN. 18</b>		
723	• OTT	BOS
724	• N.J.	NYI
725	T.B.	CAR
726	ST.L.	CBJ
727	BUF	PHX
728	ATL	FLA
729	TOR	NSH
730	MIN	DAL
731	EDM	COL
732	CGY	S.J.
<b>TUE. JAN. 19</b>		
733	T.B.	NYR
734	CBJ	PHI
735	DET	WSH
736	TOR	ATL
737	CHI	OTT
738	NYI	PIT
739	BUF	ANA
740	S.J.	L.A.
<b>WED. JAN. 20</b>		
741	FLA	N.J.
742	ST.L.	MTL
743	VAN	EDM
<b>THU. JAN. 21</b>		
744	CBJ	BOS
745	ST.L.	OTT
746	FLA	NYI
747	NYR	PHI
748	CAR	ATL
749	TOR	T.B.
750	WSH	PIT
751	DET	MIN
752	NSH	PHX
753	CHI	CGY
754	DAL	VAN
755	BUF	L.A.
756	ANA	S.J.
<b>FRI. JAN. 22</b>		
757	MTL	N.J.
758	NSH	COL
759	DAL	EDM
<b>SAT. JAN. 23</b>		
760	• OTT	BOS
761	• CAR	PHI
762	NYR	MTL

GAME #	VISITOR	HOME
<b>SAT. JAN. 23</b>		
763	N.J.	NYI
764	PHX	WSH
765	TOR	FLA
766	L.A.	DET
767	ATL	T.B.
768	ANA	ST.L.
769	CBJ	MIN
770	CHI	VAN
771	BUF	S.J.
<b>SUN. JAN. 24</b>		
772	• PIT	PHI
773	BOS	CAR
774	DAL	COL
<b>MON. JAN. 25</b>		
775	PIT	NYR
776	ST.L.	CGY
777	BUF	VAN
<b>TUE. JAN. 26</b>		
778	L.A.	TOR
779	WSH	NYI
780	ANA	ATL
781	NSH	CBJ
782	N.J.	OTT
783	MTL	FLA
784	PHX	DET
785	CHI	EDM
<b>WED. JAN. 27</b>		
786	N.J.	BUF
787	CAR	NYR
788	ANA	WSH
789	MTL	T.B.
790	DET	MIN
791	CGY	DAL
792	ST.L.	VAN
<b>THU. JAN. 28</b>		
793	ATL	PHI
794	OTT	PIT
795	NYI	CAR
796	L.A.	CBJ
797	MIN	COL
798	CGY	PHX
799	ST.L.	EDM
800	CHI	S.J.
<b>FRI. JAN. 29</b>		
801	TOR	N.J.
802	FLA	WSH
803	BOS	BUF
804	ANA	T.B.
805	NSH	DET
806	COL	DAL
<b>SAT. JAN. 30</b>		
807	• MTL	OTT
808	L.A.	BOS
809	VAN	TOR
810	NYI	PHI
811	CHI	CAR
812	CBJ	ST.L.
813	ATL	NSH
814	NYR	PHX
815	EDM	CGY
816	MIN	S.J.
<b>SUN. JAN. 31</b>		
817	• DET	PIT
818	• T.B.	WSH
819	L.A.	N.J.
820	NYI	FLA

GAME #	VISITOR	HOME
<b>SUN. JAN. 31</b>		
821	PHX	DAL
822	NYR	COL
<b>MON. FEB. 1</b>		
823	BUF	PIT
824	ANA	FLA
825	PHI	CGY
826	CAR	EDM
<b>TUE. FEB. 2</b>		
827	WSH	BOS
828	N.J.	TOR
829	T.B.	ATL
830	VAN	MTL
831	PHX	NSH
832	MIN	DAL
833	CBJ	COL
834	NYR	L.A.
835	DET	S.J.
<b>WED. FEB. 3</b>		
836	OTT	BUF
837	ST.L.	CHI
838	CAR	CGY
839	PHI	EDM
840	DET	ANA
<b>THU. FEB. 4</b>		
841	MTL	BOS
842	WSH	NYR
843	DAL	CBJ
844	VAN	OTT
845	NYI	T.B.
846	S.J.	ST.L.
847	COL	NSH
848	EDM	MIN
849	ANA	L.A.
<b>FRI. FEB. 5</b>		
850	TOR	N.J.
851	ATL	WSH
852	CAR	BUF
853	CGY	FLA
854	PHX	CHI
<b>SAT. FEB. 6</b>		
855	• VAN	BOS
856	• PIT	MTL
857	• DET	L.A.
858	PHX	DAL
859	OTT	TOR
860	CAR	NYI
861	N.J.	NYR
862	FLA	ATL
863	CGY	T.B.
864	BUF	CBJ
865	CHI	ST.L.
866	S.J.	NSH
867	PHI	MIN
868	EDM	COL
<b>SUN. FEB. 7</b>		
869	• BOS	MTL
870	• PIT	WSH
<b>MON. FEB. 8</b>		
871	S.J.	TOR
872	N.J.	PHI
873	ST.L.	COL
874	EDM	PHX
875	L.A.	ANA



# NHL SCHEDULE 2009-10



GAME #	VISITOR	HOME
<b>TUE. FEB. 9</b>		
876	BOS	BUF
877	NSH	NYI
878	FLA	CAR
879	CGY	OTT
880	VAN	T.B.
881	DET	ST.L.
882	DAL	CHI
<b>WED. FEB. 10</b>		
883	PHI	N.J.
884	NSH	NYR
885	S.J.	CBJ
886	WSH	MTL
887	NYI	PIT
888	PHX	MIN
889	ATL	COL
890	EDM	ANA
<b>THU. FEB. 11</b>		
891	WSH	OTT
892	BUF	CAR
893	BOS	T.B.
894	VAN	FLA
895	S.J.	DET
896	DAL	CGY
897	EDM	L.A.
<b>FRI. FEB. 12</b>		
898	NSH	N.J.
899	MTL	PHI
900	VAN	CBJ
901	NYR	PIT
902	TOR	ST.L.
903	ATL	MIN
904	PHX	COL
<b>SAT. FEB. 13</b>		
905	• T.B.	NYI
906	S.J.	BUF
907	PHI	MTL
908	N.J.	CAR
909	BOS	FLA
910	OTT	DET
911	WSH	ST.L.
912	DAL	PHX
913	ATL	CHI
914	ANA	CGY
915	COL	L.A.
<b>SUN. FEB. 14</b>		
916	• T.B.	NYR
917	• NSH	PIT
918	• VAN	MIN
919	OTT	NYI
920	CHI	CBJ
921	ANA	EDM
<b>FEB. 16 - 28</b> <i>Winter Olympics, Vancouver</i>		
<b>MON. MAR. 1</b>		
922	DET	COL
<b>TUE. MAR. 2</b>		
923	MTL	BOS
924	CAR	TOR
925	CHI	NYI
926	FLA	ATL
927	VAN	CBJ
928	NYR	OTT
929	BUF	PIT
930	PHI	T.B.

GAME #	VISITOR	HOME
<b>TUE. MAR. 2</b>		
931	EDM	NSH
932	L.A.	DAL
933	ST.L.	PHX
934	N.J.	S.J.
<b>WED. MAR. 3</b>		
935	WSH	BUF
936	PHI	FLA
937	VAN	DET
938	EDM	CHI
939	MIN	CGY
940	COL	ANA
<b>THU. MAR. 4</b>		
941	TOR	BOS
942	PIT	NYR
943	T.B.	WSH
944	OTT	CAR
945	NYI	ATL
946	L.A.	NSH
947	ST.L.	DAL
948	COL	PHX
949	MTL	S.J.
<b>FRI. MAR. 5</b>		
950	PHI	BUF
951	NSH	DET
952	VAN	CHI
953	N.J.	CGY
954	MIN	EDM
<b>SAT. MAR. 6</b>		
955	• DAL	PIT
956	• BOS	NYI
957	TOR	OTT
958	NYR	WSH
959	CAR	FLA
960	ATL	T.B.
961	ANA	PHX
962	ST.L.	COL
963	MTL	L.A.
964	CBJ	S.J.
<b>SUN. MAR. 7</b>		
965	• BOS	PIT
966	• VAN	NSH
967	• CGY	MIN
968	CAR	ATL
969	BUF	NYR
970	TOR	PHI
971	DET	CHI
972	N.J.	EDM
973	MTL	ANA
<b>MON. MAR. 8</b>		
974	DAL	WSH
975	CBJ	L.A.
<b>TUE. MAR. 9</b>		
976	BOS	TOR
977	NYI	PHI
978	NSH	ATL
979	T.B.	MTL
980	CGY	DET
981	FLA	MIN
982	VAN	COL
983	OTT	EDM
984	CBJ	ANA

• AFTERNOON GAME

GAME #	VISITOR	HOME
<b>WED. MAR. 10</b>		
985	DAL	BUF
986	NYR	N.J.
987	CAR	WSH
988	L.A.	CHI
989	VAN	PHX
<b>THU. MAR. 11</b>		
990	T.B.	TOR
991	ST.L.	NYI
992	BOS	PHI
993	PIT	CAR
994	ATL	CBJ
995	EDM	MTL
996	MIN	DET
997	FLA	COL
998	OTT	CGY
999	NSH	S.J.
<b>FRI. MAR. 12</b>		
1000	PIT	N.J.
1001	T.B.	WSH
1002	MIN	BUF
1003	NYR	ATL
1004	L.A.	DAL
1005	NSH	ANA
<b>SAT. MAR. 13</b>		
1006	• CHI	PHI
1007	EDM	TOR
1008	BOS	MTL
1009	N.J.	NYI
1010	PHX	CAR
1011	BUF	DET
1012	ST.L.	CBJ
1013	OTT	VAN
1014	• FLA	S.J.
<b>SUN. MAR. 14</b>		
1015	• PHI	NYR
1016	• COL	DAL
1017	• NSH	L.A.
1018	TOR	NYI
1019	PHX	ATL
1020	PIT	T.B.
1021	ST.L.	MIN
1022	WSH	CHI
1023	S.J.	ANA
1024	CGY	VAN
<b>MON. MAR. 15</b>		
1025	BOS	N.J.
1026	EDM	CBJ
1027	DET	CGY
<b>TUE. MAR. 16</b>		
1028	MTL	NYR
1029	BOS	CAR
1030	BUF	ATL
1031	TOR	OTT
1032	PHX	T.B.
1033	WSH	FLA
1034	COL	ST.L.
1035	PHI	NSH
1036	EDM	MIN
1037	S.J.	DAL
1038	NYI	VAN
<b>WED. MAR. 17</b>		
1039	PIT	N.J.
1040	CGY	COL
1041	CHI	ANA

GAME #	VISITOR	HOME
<b>THU. MAR. 18</b>		
1042	PIT	BOS
1043	ST.L.	NYR
1044	WSH	CAR
1045	OTT	ATL
1046	N.J.	TOR
1047	BUF	T.B.
1048	PHX	FLA
1049	MIN	NSH
1050	PHI	DAL
1051	S.J.	VAN
1052	CHI	L.A.
<b>FRI. MAR. 19</b>		
1053	MIN	CBJ
1054	S.J.	CGY
1055	DET	EDM
1056	NYI	ANA
<b>SAT. MAR. 20</b>		
1057	• CAR	PIT
1058	• OTT	DAL
1059	MTL	TOR
1060	ST.L.	N.J.
1061	PHI	ATL
1062	BUF	FLA
1063	WSH	T.B.
1064	CBJ	NSH
1065	CHI	PHX
1066	DET	VAN
1067	NYI	L.A.
<b>SUN. MAR. 21</b>		
1068	• NYR	BOS
1069	• CGY	MIN
1070	BUF	CAR
1071	T.B.	FLA
1072	NSH	ST.L.
1073	ATL	PHI
1074	PHX	DAL
1075	S.J.	EDM
1076	COL	ANA
<b>MON. MAR. 22</b>		
1077	PIT	DET
1078	OTT	MTL
1079	COL	L.A.
<b>TUE. MAR. 23</b>		
1080	FLA	TOR
1081	CBJ	N.J.
1082	BOS	ATL
1083	PHI	OTT
1084	CAR	T.B.
1085	DAL	NSH
1086	S.J.	MIN
1087	PHX	CHI
1088	ANA	CGY
1089	VAN	EDM
<b>WED. MAR. 24</b>		
1090	NYI	NYR
1091	PIT	WSH
1092	MTL	BUF
1093	ST.L.	DET
1094	L.A.	COL
1095	ANA	VAN
<b>THU. MAR. 25</b>		
1096	T.B.	BOS
1097	NYR	N.J.
1098	CGY	NYI
1099	MIN	PHI
1100	WSH	CAR



# NHL SCHEDULE 2009-10



GAME #	VISITOR	HOME
<b>THU. MAR. 25</b>		
1101	TOR	ATL
1102	CHI	CBJ
1103	FLA	MTL
1104	L.A.	ST.L.
1105	PHX	NSH
1106	DAL	S.J.
<b>FRI. MAR. 26</b>		
1107	OTT	BUF
1108	MIN	DET
1109	ANA	EDM
<b>SAT. MAR. 27</b>		
1110	• CGY	BOS
1111	• PHI	PIT
1112	T.B.	BUF
1113	NYR	TOR
1114	N.J.	MTL
1115	FLA	OTT
1116	ATL	CAR
1117	NYI	CBJ
1118	DET	NSH
1119	COL	PHX
1120	VAN	S.J.
1121	DAL	L.A.
<b>SUN. MAR. 28</b>		
1122	• CGY	WSH
1123	TOR	PIT
1124	EDM	ST.L.
1125	N.J.	PHI
1126	CBJ	CHI
1127	COL	S.J.
<b>MON. MAR. 29</b>		
1128	BUF	BOS
1129	CAR	ATL
1130	NSH	FLA
1131	L.A.	MIN
1132	DAL	ANA
<b>TUE. MAR. 30</b>		
1133	ATL	TOR
1134	BOS	N.J.
1135	NYR	NYI
1136	OTT	WSH
1137	T.B.	CBJ
1138	EDM	DET
1139	CHI	ST.L.
1140	L.A.	NSH
1141	PHX	VAN

GAME #	VISITOR	HOME
<b>WED. MAR. 31</b>		
1142	FLA	BUF
1143	CAR	MTL
1144	T.B.	PIT
1145	CHI	MIN
1146	S.J.	DAL
1147	ANA	COL
1148	PHX	CGY
<b>THU. APR. 1</b>		
1149	FLA	BOS
1150	BUF	TOR
1151	PHI	NYI
1152	ATL	WSH
1153	CAR	OTT
1154	CBJ	DET
1155	ST.L.	NSH
1156	VAN	L.A.
<b>FRI. APR. 2</b>		
1157	CHI	N.J.
1158	MTL	PHI
1159	NYR	T.B.
1160	S.J.	MIN
1161	EDM	DAL
1162	CGY	COL
1163	VAN	ANA
<b>SAT. APR. 3</b>		
1164	• ATL	PIT
1165	• OTT	NYI
1166	• NSH	DET
1167	BOS	TOR
1168	BUF	MTL
1169	N.J.	CAR
1170	NYR	FLA
1171	WSH	CBJ
1172	DAL	ST.L.
1173	EDM	PHX
1174	ANA	L.A.
<b>SUN. APR. 4</b>		
1175	• DET	PHI
1176	• CGY	CHI
1177	S.J.	COL
1178	MIN	VAN

GAME #	VISITOR	HOME
<b>MON. APR. 5</b>		
1179	BOS	WSH
1180	CBJ	ST.L.
1181	MIN	EDM
<b>TUE. APR. 6</b>		
1182	NYR	BUF
1183	PHI	TOR
1184	MTL	NYI
1185	N.J.	ATL
1186	WSH	PIT
1187	CAR	T.B.
1188	OTT	FLA
1189	CHI	DAL
1190	S.J.	CGY
1191	COL	VAN
1192	L.A.	ANA
<b>WED. APR. 7</b>		
1193	TOR	NYR
1194	CBJ	DET
1195	ST.L.	CHI
1196	COL	EDM
1197	NSH	PHX
<b>THU. APR. 8</b>		
1198	BUF	BOS
1199	MTL	CAR
1200	NYI	PIT
1201	OTT	T.B.
1202	N.J.	FLA
1203	ANA	DAL
1204	MIN	CGY
1205	PHX	L.A.
1206	VAN	S.J.
<b>FRI. APR. 9</b>		
1207	PHI	NYR
1208	ATL	WSH
1209	DET	CBJ
1210	ANA	ST.L.
1211	CHI	COL

GAME #	VISITOR	HOME
<b>SAT. APR. 10</b>		
1212	• CAR	BOS
1213	• EDM	L.A.
1214	TOR	MTL
1215	BUF	OTT
1216	NYI	N.J.
1217	PIT	ATL
1218	FLA	T.B.
1219	ST.L.	NSH
1220	DAL	MIN
1221	CGY	VAN
1222	PHX	S.J.
<b>SUN. APR. 11</b>		
1223	• NYR	PHI
1224	• BOS	WSH
1225	• DET	CHI
1226	• L.A.	COL
1227	BUF	N.J.
1228	PIT	NYI
1229	T.B.	FLA
1230	EDM	ANA

• AFTERNOON GAME

